

FS1-X

Installation & Operation Guide

Version 1.1r4

Published: Nov. 28 2022



Because it matters.®

AJA
VIDEO SYSTEMS

Table of Contents

Notices	10
Trademarks	10
Copyright	10
Contacting Support	10
Chapter 1: Introduction	11
Overview	11
Video Features	11
Audio Features	12
Other Features	12
Typical Applications	12
FS1-X Control	13
Front Panel Control	13
Remote Web Browser Control	13
GPI Inputs and Outputs	13
SNMP Interface Monitoring	13
Optional FS1-X Features	13
Frame Rate Converter (FRC)	13
Fiber I/O	14
Technical Description	14
Video Processors	15
Audio Processor	15
Operation Overview	15
About Inputs and Outputs	15
About Reference and Genlock Source	15
1 Channel vs. 2 Channel FS1-X Operation	16
Sidebar Video Keying	16
Retained Settings	16
In This Manual	17
Chapter 2: Controls, Indicators, and Connections	18
Overview	18
Front Panel Description	18
Alphanumeric Display	18
Operational Summary	19
Pushbuttons	19
Control Knobs	21
LED Indicators	22
Incompatibility Alarms	23
Example Reference and Video Incompatibility Alarms	23
Rear Panel Description	24
Connectors	24
Chapter 3: Installation & Configuration	27
Installation Overview	27
Installation Summary	27
Unpacking	28
Shipping Box Contents	28
Installing Optional Fiber Optic I/O Modules	28
FS1-X Chassis Installation	29
Physical Requirements for Mounting the Chassis	29

Chassis Dimensions	29
Cabling and Cooling Requirements	29
Power Requirements	29
Networking	30
FS1-X Default Network Settings	31
Networking Using DHCP or Default Static IP	31
Networking the FS1-X Using Your Own Static IP	31
Using Ping to Test the Network Connection	33
Mac Ping Procedure	34
Windows PC Ping Procedure	34
Web Browser Control	34
Software Update Installation	34
Download the Latest Software	34
Unpack the Software	35
Uploading and Installing the Software to the FS1-X	35
System Cabling	36
System Video/Audio Cable Connections	36
GPI Connections	36
FS1-X Audio Level Choices—Pro or Consumer, US or EBU	36
Stand Alone Tests	38
First Power Up	38
Setup	38
Procedure	38
Internal Test Signals to All Outputs	39
Setup	39
Procedure	39
FS1-X Processing Examples	40
SD to Sidebar HD over Matte	40
Setup	40
Procedure	40
HD to Letterbox SD over Video	41
Setup	41
Procedure	41
Conversion Across Frame Rate Families	41
Setup	42
Procedure	42
Chapter 4: Display Menus	44
Overview	44
Parameter Menus	44
Menu Operation Examples	45
Status Pages	45
Simple Menus: Config Format Alarm Filters	45
Hidden Parameter Menus: Video ProcAmp	46
Multiple Field Parameters: IP Address	47
Menu Parameter Interactions	48
STATUS Menu Group	48
I/O Status	49
Vid1 Format Status	49
Vid1 Format Alarm Status	49
Vid2 Format Status	49
Vid 2 Format Alarm Status	49
Output Status	50
Power/Temp Alarm	50

Caption Status	50
FRC Status	50
MADI Status	50
System Status.....	51
REMOTE Menu Group	51
1 Remote Control	51
1.1 Authentication	51
2.1–4 GPI IN 1–4 Response.....	52
3.1–4 GPI 1–4 OUT	54
Interaction of Presets and GPIs	54
Example of a Serial Recall	54
Example of an Unintended Recall.....	54
CONFIG Menu Group	54
1 System Name	54
Name Entry Procedure	54
2.1 IP Config	55
2.2 IP Address.....	55
Octet Value Entry Procedure	55
2.3 Subnet Mask	55
2.4 Default Gateway.....	55
3 MAC Address (view only)	56
4 SNMP Menu Parameters	56
5 Power Supply Alarm.....	56
6.1 Vid1 Format Alarm.....	56
6.2 Vid2 Format Alarm.....	56
7 Reference Alarm.....	57
8 Hidden Menus	57
9 Screen Saver	57
10 Display Intensity	57
11 Fan Speed	57
12 Serial Number.....	57
13 Software Version	57
14 Reboot	57
PRESET Menu Group.....	58
1 Factory Preset	58
1.1–1.40 Presets #1–#40	58
Video with Audio Routing	58
Interaction of Presets and GPIs	59
SYSTEM Menu Group	59
1 Analog In Format.....	59
2 Component Out Format	59
3 Analog Audio Std	59
4 SDI1 3G Detect	59
5 SDI2 Input Protect.....	60
6 Fiber1 3G Detect	61
7 Fiber2 Input Protect	61
8 Genlock Source	61
9 Output Frame Rates	61
10 FRC Enable.....	61
11 NTSC Standard.....	62
12 Composite Downconv.....	62
13 HDMI RGB Range.....	62
14.0 AES/EBU SRC Mode.....	63
14.1–14.8 AES/EBU SRC.....	63

15.1 MAD1 BNC Out	64
15.1 MAD1 Fiber Out.....	64
VIDEO PROC Menu Group	64
Video Input and Output	64
1.1 Video 1 Input.....	64
1.2 Video 2 Input.....	65
2 Output Format.....	65
3 Video 1 Output Mode	65
Loss of Input	65
4.1 Video 1 Loss of Input.....	65
4.2 Video 2 Loss of Input	65
Timing and Delay	66
5.1 Video 1 Output Timing H	66
5.2 Video 1 Output Timing V	67
5.3 Video 1 Frame Delay.....	67
5.4 Video 2 Output Timing H	67
5.5 Video 2 Output Timing V	67
5.6 Video 2 Frame Delay.....	67
Background Fill	67
6 Background Fill	67
Upconvert and Downconvert.....	67
7 Upconvert Mode	68
8 Downconvert Mode.....	69
SD Aspect Ratio	70
9 SD Aspect Ratio Convert	70
Sidebars	71
10 Sidebar Edge	71
Matte of Background Fill	72
11.1 Matte Luma.....	72
11.2 Matte Chroma	72
11.3 Matte Hue	72
Proc Amp Controls (YUV).....	72
12.0 Proc Amp (YUV).....	72
12.1 Proc Amp Gain.....	72
12.2 Proc Amp Black	72
12.3 Proc Amp Hue	72
12.4 Proc Amp Sat	73
Color Corrector (RGB)	73
13.0 Color Corrector (RGB)	73
13.1 Color Red Gain	73
13.2 Color Red Black Level.....	73
13.3 Color Red Gamma.....	73
13.4 -13.6 Color Green	73
13.7-13.9 Color Blue.....	73
Custom Conversion Settings	73
14.0 Custom Size/Pos	73
14.1 Custom Size	74
14.2 Custom Aspect.....	74
14.3 Custom H Position	74
14.4 Custom V Position.....	74
14.5 Custom Left Crop	74
14.6 Custom Right Crop.....	74
14.7 Custom Top Crop	74
14.8 Custom Bottom Crop.....	74

Region of Interest (ROI)	75
15.0 Region of Interest	75
15.1 ROI Left	75
15.2 ROI Right	75
15.3 ROI Top	75
15.4 ROI Bottom	75
Video Legalizer	75
16.0 Video Legalizer	76
16.1 Legalizer White Clip	76
16.2 Legalizer Black Clip	76
16.3 Legalizer Chroma Clip	76
AFD	76
17.1 AFD Out	77
17.2 AFD VANC Output Lines	77
17.3 Downcvt AFD Dflt	78
Closed Captioning	78
18 Caption Xlator	78
Input Scan and PSF	79
19.1 Video 1 Input Scan Format	79
19.2 Video 2 Input Scan Format	79
SD Line 21 Closed Caption Blanking	79
20 SD Line 21 Blanking	79
Test Pattern	80
21 Video 1 Test Pattern	80
Freeze Output	80
22.1 Video 1 Freeze Output	80
22.2 Video 2 Freeze Output	80
Reverse Telecine	80
About Reverse Telecine and Film Cadence (3:2 and 2:3:3:2)	80
FS1-X Reverse Telecine Conditions	81
23 Reverse Telecine	81
VIDEO OUTPUT Menu Group	81
1.1 SDI1 Video Out	81
1.2 SDI2 Video Out	81
2.1 Fiber1 Video Out	82
2.2 Fiber2 Video Out	82
3 HDMI Video Out	82
4 Analog	82
5.1 SDI1 3G Config	82
5.2 SDI2 3G Config	82
6.1 Fiber1 3G Config	83
6.2 Fiber2 3G Config	83
AUDIO PROC Menu Group	83
1.0 SDI1 Level	83
1.1-1.16 SDI 1 Channel Levels	83
2.0 SDI1 Phase	84
2.1-2.16 SDI 1 Channel Phase	84
3.0 SDI1 Delay	84
3.1 SDI 1 Delay Global	84
3.1-3.8 SDI 1 Channel Pair Delay	85
4.0/5.0/6.0 SDI 2 Level, Phase, Delay	85
7.0/8.0/9.0 Fiber1 Level, Phase, Delay	85
10.0/11.0/12.0 Fiber2 Level, Phase, Delay	85

13.0/14.0/15.0 AES Level, Phase, Delay	85
16.0/17.0/18.0 MADI BNC Level, Phase, Delay	85
19.0/20.0/21.0 MADI Fiber Level, Phase, Delay	85
22.0/23.0/24.0 HDMI Level, Phase, Delay	86
25.0/26.0/27.0 Analog Level, Phase, Delay	86
28.0 Mix Down 1 Mode	86
About Mix Down Mode	86
28.1 Mix Down 1 Input	87
28.2 - 28.8 Mix Down 1 Input Mapping (LF, RF, CTR, LR, RR, LS, RS)	87
28.9 - 28.14 Mix Down 1 Input Level	87
28.16 - 28.17 Mix Down 1 Output Lft Rt Level	87
29.0 Mix Down 2 Mode	87
30.0 Mix Down Reset	88
34 Embedded Audio Out	88
AUDIO OUTPUT Menu Group	88
1.0 SDI1 Audio Out	88
1.1-1.16 SDI1 Output Channel	89
2.0 SDI2 Audio Out	89
3.0 Fiber1 Audio Out	89
4.0 Fiber2 Audio Out	89
5.0 AES/EBU Audio Out	89
6.0 MADI BNC Audio Out	89
7.0 MADI Fiber Audio Out	89
8.0 HDMI Audio Out	90
9.0 Analog Audio Out	90
11 Global Output	90
12 Reset Mapped Output	90
Chapter 5: Browser Remote Control	91
Remote FS1-X Control Via a Web Browser	91
General Web Browser Screen Description	91
Controlling Multiple FS1-Xs	92
Resetting Values To Factory Settings	93
Drop Down Parameter Operation	93
Slider Operation	93
Sub-Menus	93
Screen Descriptions	93
Network Pane and Network Configuration Screen	94
IP Address Type	94
IP Address	95
Netmask	95
Default Gateway	95
Alarm Configuration Screen	96
Status Screen	97
System Screen	98
Config Screen	99
System Name	100
SNMP Parameters	100
Hidden Menus	100
Display Intensity	100
UPnP Host	100
UPnP Proxy	101
Presets Screen	101
Presets Screen Controls	101

Factory Preset	101
Recall	102
Store	102
Export	102
Import	102
Export Presets 1–40 (All)	102
Import Presets 1–40 (All)	102
Interaction of Presets and GPIs	102
Video Proc Screen	103
Video Output Screen	104
Audio Proc Screen	105
Audio Output Screen	106
Remote Screen	107
Firmware Screen	108
Chapter 6: SNMP	109
FS1-X Simple Network Management Protocol	109
SNMP Configuration	109
Front Panel Screens	109
Front Panel Octet Value Entry Procedure	110
Web Browser	110
SNMP Configuration Parameters	111
4.0 SNMP Enable	111
4.1 SNMP Trap Destination 1	111
4.2 SNMP Trap Port 1	111
4.3 SNMP Trap Destination 2	111
4.4 SNMP Trap Port 2	111
Appendix A: Specifications	112
Video Input/Output Formats	112
Video Format Conversion	113
Video A/D, D/A Converters	116
Audio	116
Interfaces	117
Physical	117
Appendix B: FS1-X Pinouts	118
GPI Pinouts	118
Audio Connection Pinouts	119
Analog Audio	119
Digital Audio	119
Appendix C: Safety & Compliance	121
Federal Communications Commission (FCC) Compliance Notices	121
Class B Interference Statement	121
FCC Caution	121
Canadian ICES Statement	121
European Union and European Free Trade Association (EFTA)	
Regulatory Compliance	122
Declaration of Conformity	122
Korean KCC Compliance Statement	123
Taiwan Compliance Statement	123
Recycling Notice	123
Translated Warning and Caution Messages	123
Before Operation Please Read These Instructions	124

Warranty Information **130**
Limited Warranty 130
Index..... **131**

Notices

Trademarks

AJA® and Because it matters.® are registered trademarks of AJA Video Systems, Inc. for use with most AJA products. AJA™ is a trademark of AJA Video Systems, Inc. for use with recorder, router, software and camera products. Because it matters.™ is a trademark of AJA Video Systems, Inc. for use with camera products.

Corvid Ultra®, Io®, Ki Pro®, KONA®, KUMO®, ROI® and T-Tap® are registered trademarks of AJA Video Systems, Inc.

AJA Control Room™, KiStor™, Science of the Beautiful™, TruScale™, V2Analog™ and V2Digital™ are trademarks of AJA Video Systems, Inc.

All other trademarks are the property of their respective owners.

Copyright

Copyright © 2020 AJA Video Systems, Inc. All rights reserved. All information in this manual is subject to change without notice. No part of the document may be reproduced or transmitted in any form, or by any means, electronic or mechanical, including photocopying or recording, without the express written permission of AJA Video Systems, Inc.

Contacting Support

When calling for support, have all information at hand prior to calling.

To contact AJA for sales or support, use any of the following methods:

Telephone: +1.530.271.3190

FAX: +1.530.271.3140

Web: <http://www.aja.com>

Support Email: support@aja.com

Sales Email: sales@aja.com

Chapter 1: Introduction



Overview

Matching up and synchronizing disparate video and audio formats is a critical part of any broadcast, mobile or post-production environment. AJA's FS1-X is the next evolution in frame synchronization and conversion. Within its compact 1RU chassis, FS1-X integrates an amazing array of video and audio connectivity and processing. Featuring a flexible architecture, FS1-X simultaneously works with 3G/HD/SD-SDI 10-bit broadcast quality video and incorporates embedded audio, AES, MAD1, and analog audio.

Utilizing AJA's remarkable conversion algorithms, FS1-X supports up, down and cross-conversion between SD and HD signals for the highest quality output possible. Additionally, the factory-installed motion adaptive Frame Rate Converter (FRC) option enables high quality conversions between different frame rate families for virtually unlimited international standards support.

NOTE: The Frame Rate Converter option for FS1-X is no longer available from AJA.

The growth of 5.1 and 7.1 audio has increased the number of audio channels that must be managed in a production. The MAD1 standard provides a convenient way to transport huge numbers of audio channels along a single cable, simplifying the cabling demands for broadcasters, mobile trucks and production. FS1-X supports both fiber and coax 64 channel MAD1 input and output. An internal 224x224 audio matrix allows full routing of MAD1 and all audio coming from SDI, fiber, AES and analog sources for an incredible amount of audio processing capability in a single box.

FS1-X features a unique keyer configuration, allowing incoming signals to be combined in powerful ways. A common example is sidebar keying, where incoming video is converted from SD to HD but rather than stretching the 4:3 aspect ratio to fit in a 16:9 frame, a second signal is used to fill the sides of the 16:9 frame. This allows channel identification or other imagery to be placed in that area rather than having black bars on either side. The robust AFD features of FS1-X ensure that the aspect ratio of the outgoing signal is properly identified for downstream devices.

Video Features

- The FS1-X handles a wide variety of video formats. See ["Video Input/Output Formats" on page 112](#) for a complete list.
- Video format converter, featuring SD/HD (up/down), 2K/HD (up/down), SD-to-SD (aspect ratio), and HD-to-HD (720/1080 cross) conversions.
- Video proc amp and color correction.
- Dual frame synchronizers.
- User-specified custom format conversion and scaling with variable crop, size, aspect, position, and Region of Interest parameters.
- Sidebar keying over black, matte, or the same format video.

- Closed captioning support, featuring true conversion between EIA 608 and 708 (SD and HD) CC formats.
- Active Format Description (AFD) support.
- Dual 3G/HD/SD SDI I/O with embedded audio.
- Dual 3G/HD/SD Single-Mode Optical Fiber I/O (optional).
- HDMI I/O.
- Component/Composite analog HD/SD video I/O, 12-bit.
- Looping reference input with flexible genlock.
- Film cadence removal (3:2 and 2:3:3:2) from an i59.94 input to a p/PsF23.98 output.

Audio Features

- 16 channel AES/EBU digital audio I/O (2x 25pin D connector).
- 8 ch balanced analog audio I/O (2x 25pin D connector).
- 64 or 56 channel MADI digital audio I/O (2x BNC).
- 64 or 56 channel MADI Fiber digital audio I/O (2x Multi-Mode Optical Fiber).
- Automatic MADI channel conversion (64 input to 56 output drops channels 57-64, 56 input to 64 output adds silent channels 57-64).
- 48,000 +/- 0.2% MADI sample rate support with sample add/drops.

NOTE: *MADI 96kHz and 192kHz sample rates and vari-speed are not supported.*

- 5.1 and 7.1 mix down to stereo.
- Flexible audio routing, from any or all inputs to any or all outputs, including embedded audio.

Other Features

- Built-in front panel control via scrolling alphanumeric and graphical menu.
- Front panel LED status indicators for at-a-glance system monitoring.
- Linux operating system supporting full network compatibility, including Web-based remote control over 10/100/1000 Ethernet via an internal web server.
- Two fully redundant power supplies standard.
- Five-year international warranty with unlimited technical support.

Typical Applications

The FS1-X can be used in a very wide variety of video and audio signal conversion, adaptation, timing, and processing applications:

- Up/down/cross conversion between many SD and HD formats, including 1080p50/59.94.
- General purpose video frame synchronization.
- Analog-to-Digital and Digital-to-Analog audio/video conversion.
- Mux or Demux two separate HD signals from one 3G SDI signal.
- Convert 3G/HD/SD video over fiber to/from SDI (BNC).
- Use the built-in video processing amplifier to adjust and/or color correct.
- HD sidebar keying (black, matte, or identical format video).
- Routing audio signals from up to 224 audio inputs to various format audio outputs, by mapping sets of sources to outputs, with control of level and phase of individual audio channels, and control of delay on channel pairs.

FS1-X Control

FS1-X operation can be monitored and changed in a number of ways. Feature sets in each of the control methods vary, although the front panel and web browser interfaces offer many of the same features.

Front Panel Control

The FS1-X front panel offers the most direct control, ideal for use in machine rooms or wherever quick changes and status checks must be made. The buttons and knobs control menus in the display, allowing you to fully configure the system according to your purposes. You can control inputs, outputs, processing paths, keying, and much more.

Remote Web Browser Control

The FS1-X internally contains an optimized web server that allows remote monitoring and parameter setting via an Ethernet 10/100/1000 network-attached computer running a web-browser. Networks can be closed local area networks, a straight computer-to-FS1-X cable, or for greatest flexibility, exposed through a firewall to a broadband WAN. From a network-connected computer you can communicate with one or more FS1-X devices, even getting them to identify themselves via LEDs on the front and rear panel.

GPI Inputs and Outputs

General Purpose Inputs and Outputs are available on the FS1-X back panel to provide contact closure control. Using the inputs, an external contact closure activates a specified function on the FS1-X. Using the outputs, specific FS1-X functions can produce a contact closure to activate any desired function on external equipment. The functions to be activated by an input or that can activate an output are set using the front panel and browser menus.

SNMP Interface Monitoring

SNMP offers remote network monitoring of alarm conditions.

Optional FS1-X Features

Frame Rate Converter (FRC)

NOTE: The Frame Rate Converter option for FS1-X is no longer available from AJA.

The factory installed Frame Rate Converter option enables conversions between the three video frame rate families:

- 59.94/29.97/23.98
- 50/25
- 24

The standard FS1-X (without FRC) can also perform conversions, but only between frame rates that are within the same frame rate family, using add/drop frames.

The FRC option provides:

- High quality motion adaptive linear frame rate conversion
- Multi field/frame 3D pixel by pixel motion adaptation
- 1080p50/59.94 support
- Format and Frame rate conversion can be combined (for example, 625i/50 IN, 1080i/59.95 OUT)

Fiber I/O

The FS1-X supports optional AJA Optical Fiber I/O modules as follows:

- Single Input, LC connector
- Single Input SC connector
- Single Output LC connector
- Single Output SC connector
- Dual Input LC connectors
- Dual Output LC connectors

FS1-X's Fiber I/O supports the 3G/HD/SD SDI protocol. Only AJA modules are supported; use of other manufacturers' modules is not supported and may void the warranty.

Technical Description

The FS1-X features an incredibly flexible architecture, offering a powerful Video Processor for video conversion and processing, an optional Frame Rate Converter for even greater conversion capabilities, a second Video Processor, a separate Audio Processor, and extensive input and output video and audio signal routing.

Figure 1. FS1-X Simplified Block Diagram

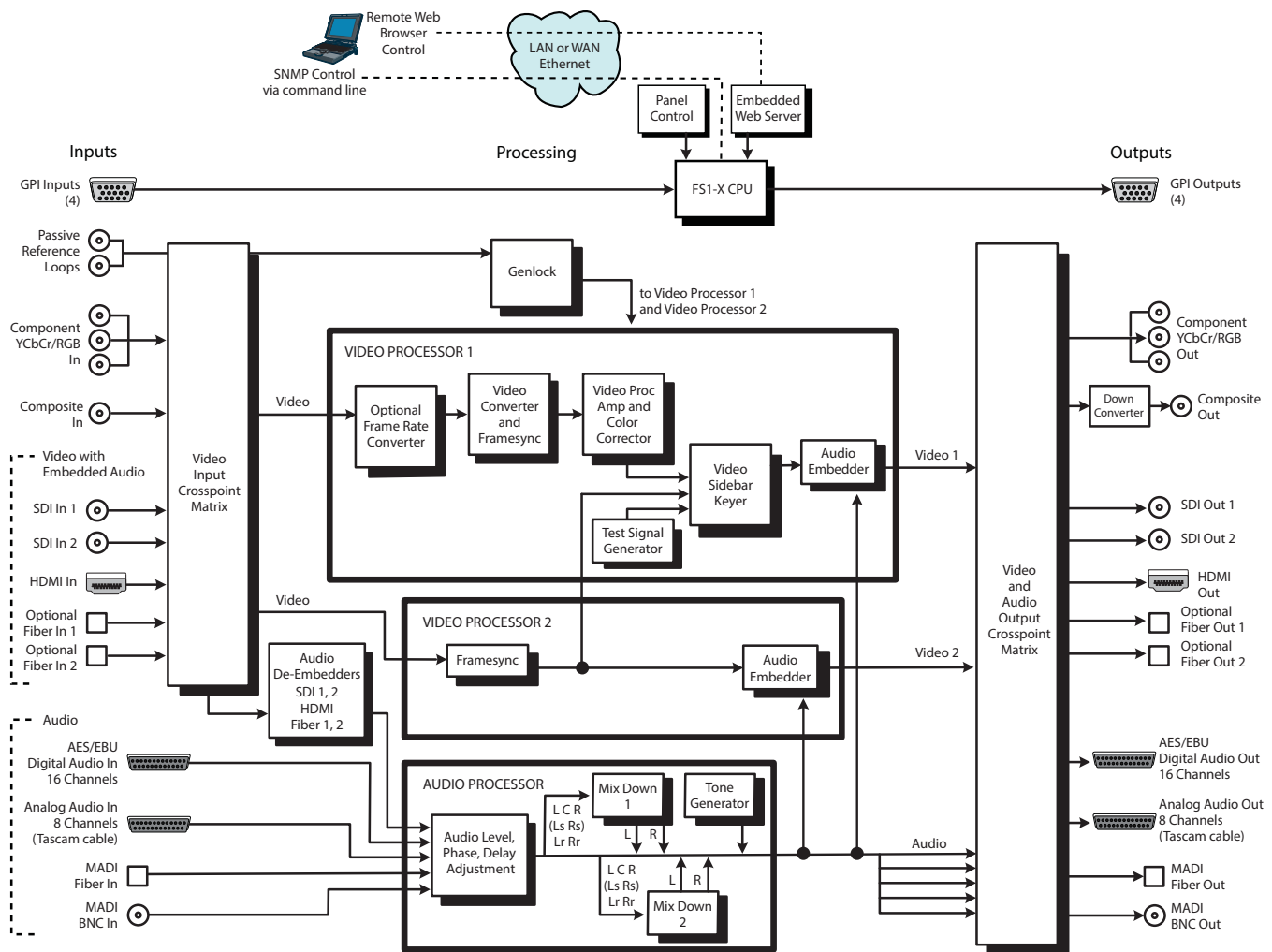

Video Processors

Video Processor 1 performs format conversion, frame synchronization, signal processing, and keying operations. The factory installed Frame Rate Converter option resides in Video Processor 1.

Video Processor 2 offers frame synchronization and the ability to feed video to the first Video Processor for sidebar keying. Each video processor has access to any video input and output using the Crosspoint Matrices.

Up, down, or cross conversion is done with very high quality scalars. De-interlacing is performed with high quality motion-adaptive processing including diagonal filters. The Processing Amplifier and Color Corrector supports video signal adjustment with standard Proc Amp controls and RGB-style color correction.

Audio Processor

The Audio Processor accepts analog, digital, or embedded audio, and performs high quality A/D, D/A, and sample rate conversions as required. Inputs can be selected from Embedded (SDI, Fiber, or HDMI), MADI BNC or Fiber, AES, or Balanced Analog.

The output of the Audio Processor can be embedded in either Video Processor's output (SDI, Fiber, or HDMI), or sent to the MADI, AES or Balanced outputs. Full audio channel mapping supports any mixture of inputs to outputs.

Dolby 5.1 and similar schemes of digital encoded audio can be passed unaltered, provided the input is genlocked to the FS1-X output.

Two internal mixers are also available that each permit mixing down five inputs (5.1) or seven inputs (7.1) to a left/right stereo mix.

Operation Overview

About Inputs and Outputs

In general, to use the FS1-X for video conversion, first select an Output Video Format (with the VIDEO PROC, Output Format Menu) that is compatible with the current FS1-X genlock source (see "[About Reference and Genlock Source](#)" below), then select an Input port on Video Processor 1 (with the VIDEO PROC, Video 1 Input menu). The FS1-X will automatically determine the selected input video format and convert it (if necessary) to the selected Output Video Format. You can now route that converted video to any or all of the FS1-X output ports, by selecting each output (with the VIDEO OUTPUT menu) and assigning Processor 1 to that port.

About Reference and Genlock Source

A genlock source being used by the FS1-X for reference must be compatible with the FS1-X video output format. These signals are compatible when they are both in the same frame rate family (59.94/29.97/23.98, or 50/25, or 24).

The FS1-X can be configured to operate with one of a variety of references, including genlock to the signal from the Reference input connector, genlock to the current Video Processor 1 input signal, or Free Run. Your choice of reference needs to meet your individual facility requirements, and must be accounted for when you configure the FS1-X video output format.

The same FS1-X reference is used by both Video Processor 1 and Video Processor 2. The Video Processor 2 output format always matches its input format (no conversion is performed). If you use the Video Processor 2 output you will need to make sure its output video format (which is determined by its input format) is compatible with the currently used FS1-X reference.

It is also recommended to use an interlaced video reference when the output signal is interlaced, to ensure downstream equipment can process the interlaced video properly. Progressive video output can safely use either an interlaced or progressive reference signal.

1 Channel vs. 2 Channel FS1-X Operation

The FS1-X has two modes of operation: 1 Channel mode and 2 Channel mode.

1 Channel mode is available when the FRC option is present and enabled. In this mode, the full range of frame rate conversions are available using Video Processor 1. Video Processor 2 is disabled in this mode and reports no output, although a black video signal is generated if Video Processor 2 is routed to an output. Any embedded audio routed to a Video Processor 2 output will also be passed along with that black video signal.

2 Channel mode is available when the FRC is absent or has been disabled. In 2 Channel mode frame rate conversions within the same frame rate family are supported on Video Processor 1, and Video Processor 2 is available for use. For example, Video Processor 2 can be used to pass an unprocessed alternative version of the incoming video. Select the same input port used by Video Processor 1 on Video Processor 2 (with the VIDEO PROC, Video 2 Input menu), and route that video to a different output port by selecting that output (with the VIDEO OUTPUT menu) and assigning Video Processor 2 to that port. Video Processor 2 does not perform conversion, so for most ports the Video Processor 2 output video will match its input. However, Video Processor 2 video can be routed to the composite Video Output for downconversion. The composite Video Output port has a separate dedicated Downconverter so it can always display SD video even if it is selected to output a Video Processor that is configured for HD.

Sidebar Video Keying

The FS1-X can be configured to perform sidebar keying (useful when converting between HD and SD with different image aspect ratios). Sidebar keying black or matte is always available. It is also possible to sidebar key a video signal from Video Processor 2 under the following conditions:

- The FRC option is disabled or not present (FS1-X is operating in 2 Channel mode).
- The Video Processor 2 video input signal format exactly matches the Video Processor 1 output format.
- The H and V Output timing settings of both Video Processor 1 and 2 are identical.
- The FS1-X reference being used is compatible with the Video Processor 2 input signal.

Retained Settings

The FS1-X stores the current value of each operational parameter in Flash memory so that the system returns to the same state after a power cycle.

The FS1-X also stores independent values for many settings, so that if the unit is configured for one operation, changed to a different operation, and then returned to that prior operation, the settings for that prior operation are restored.

For example, changing the Video Input selection automatically selects new values for Proc Amp parameters and RGB Proc Amp parameters. This is referred to as Source Memory. Each video source remembers its own Proc Amp settings.

Similarly, changing the Output Format selection automatically selects new values for H & V timing parameters. This is referred to as Output Timing Memory. Each Output Format mode remembers its own H & V timing settings.

As another example, Output Format Mapping stores the Output Format selected for any of the frame rates. That Mapped Output Format is recalled if the frame rate selection is changed.

Presets can also be used to restore the FS1-X to a previous state. Many parameters can be individually reset to factory values using individual menus, or the entire FS1-X can be reset to defaults (with the PRESET, Factory Preset menu).

In This Manual

Chapter 1: Introduction provides an overview and a list of box contents.

Chapter 2: Controls, Indicators, and Connections describes controls, indicators, and connections.

Chapter 3: Installation and Configuration provides complete instructions for installing and configuring the FS1-X.

Chapter 4: Display Menus explains how to use the FS1-X controls and display menus.

Chapter 5: Browser Control explains how to use the FS1-X remotely via a web browser on a network-attached computer.

Chapter 6: SNMP discusses FS1-X support of SNMP.

Appendix A: Specifications presents a list of technical specifications for the product.

Appendix B: Pinouts explains the FS1-X rear panel connector pinouts.

Appendix C: Safety & Compliance provides regulatory compliance statements, advisories and warnings.

Index

Chapter 2: Controls, Indicators, and Connections

Overview

The controls, indicators, and connectors illustrated and described in this chapter allow you to connect, operate, and monitor the FS1-X system and to troubleshoot problems if you encounter them. Becoming familiar with the FS1-X front and rear panels also simplifies system installation, setup, and operation.

Front Panel Description

Figure 2. AJA FS1-X Front Panel Controls and Indicators

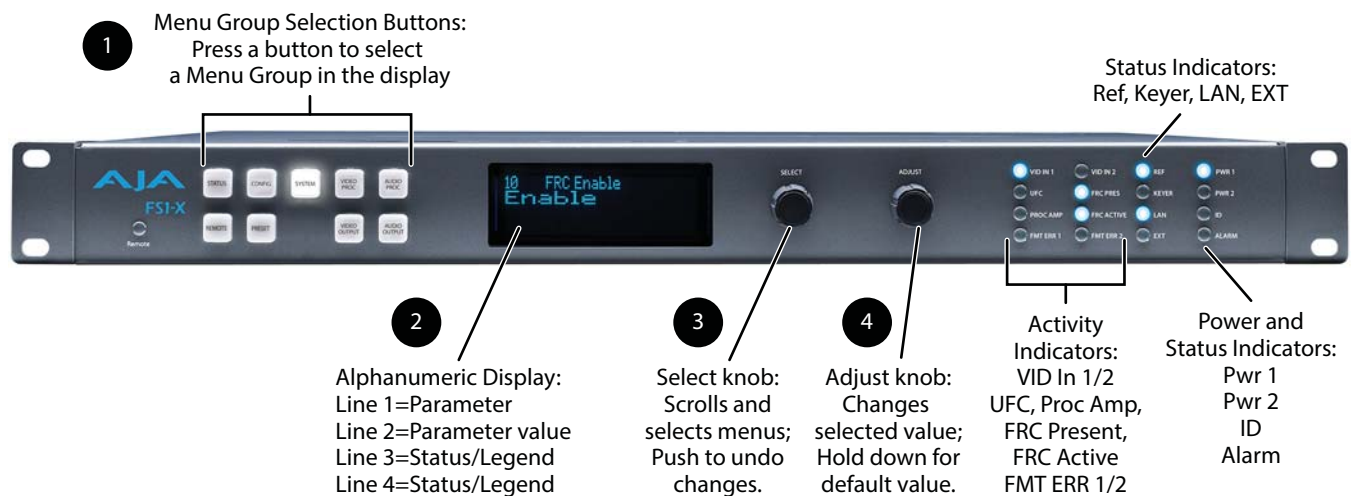

Alphanumeric Display

The FS1-X's control system is designed to be quick and easy to use. The four-line alphanumeric display shows menus that are numbered and grouped by function. The menu groups are easily accessed using pushbuttons which correspond one-to-one with the groups (one button per menu group). The menu lines, which are 23 characters wide, display the following information:

- **First line**—parameter number and name.
- **Second line**—the editable value set for a parameter.
- **Third and fourth lines**—current status, labels, or prompts.

Figure 3. Four Lines of the Front Panel Display

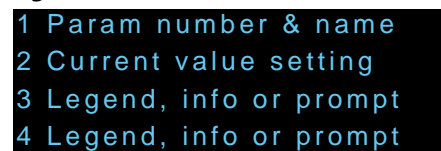

When you edit a parameter containing multiple values, such as the IP address, the value currently being edited blinks.

Operational Summary

The nine front panel pushbuttons allow you to select display menu groups. The two knobs allow you to change menus and set parameters within the menu groups. These functions can be summarized as follows:

- Select a menu group: Press one of the ten pushbuttons.
- Scroll through menus in a group: Turn *SELECT*.
- Edit a menu parameter: Stop *SELECT* on the menu.
- Change a parameter value: Once the parameter is selected with *SELECT*, turn *ADJUST* to set the value. Changes apply in a few seconds.
- To edit a multiple part parameter, such as the IP address, push the *ADJUST* knob momentarily (the value blinks). To save the whole parameter after editing, push *ADJUST* momentarily again.
- Coarse adjust a value (for use with parameters that have more than 10 selections):
 - 10x speed - Hold down the menu group button (the button turns blue) and turn *ADJUST*. The values will change in 10x increments.
 - 100x speed (available for extremely wide-range parameters, like Audio Delay) - After enabling 10x speed above, momentarily release and press that group button a second time (the button turns light blue). Turning *ADJUST* will now change the value in 100x increments.
- Undo a change (restore previous setting): Push *SELECT* momentarily.
- Reset to factory default: Hold down *ADJUST* for 4 seconds.

Pushbuttons

The general rules of Menu Group button operation are:

- Press one of the nine Menu Group buttons to access the associated menu group. The *SELECT* and *ADJUST* knobs control the display menus.
- The selected Menu Group button lights and the other buttons turn off.
- Each menu group returns to the last menu changed when you select the button. After a reboot, each group displays its first menu.
- Hold down a button (turns blue) to make coarse adjustments using the *ADJUST* knob. Release the button to make fine adjustments. See [“Coarse adjust a value \(for use with parameters that have more than 10 selections\):” on page 19.](#)

The following text briefly lists the functions accessed by each pushbutton:

- STATUS** Displays the Status Menu Group, which shows current machine status and error conditions:
- Video 1, Video 2, and Caption status
 - Reference and Genlock status
 - Output Status
 - Power and Temperature status
 - System Name display
 - Alarms
 - FRC status
 - Audio Output routing
- REMOTE** Displays the Remote Menu Group, which lets you select how to control the FS1-X:

- Control by local front panel, or local and remote
- Authentication
- GPI input and output behavior

CONFIG Displays the Config Menu Group, which lets you configure the FS1-X for your environment:

- System Name setting
- IP settings, MAC address
- SNMP settings
- Alarm control
- Hidden Menus, Screen Saver, and Display intensity
- Fan speed
- System serial number and software version
- System reboot

PRESET Displays the Reg Menu Group, which accesses the memory registers:

- Store, Recall, and edit the names of Presets
- Factory Preset (defaults)

SYSTEM Displays the System Menu Group, which lets you change or enable FS1-X video and audio input and system functions:

- Video input format settings, including Analog and 3G setup
- Video component output format settings
- Analog audio standard levels
- Genlock reference source selection
- Output frame rate selection
- Frame Rate Converter option enable
- NTSC standard selection
- Composite video downconvert settings (HD to SD)
- HDMI RGB Range
- AES audio input format and sample rate conversion settings

VIDEO PROC Displays the Menu Groups that access Video Processor video input, format, and conversion selections and adjustments:

Settings for both Video Processor 1 and 2:

- Input source selections
- Loss of input selection
- H and V timing and delay settings
- Freeze output setting
- Input scan format (pSF de-interlacer) settings

Setting for Video Processor 1 only:

- Output format and mode
- Background fill selection
- Conversion (up, down, aspect, edge, ROI, and custom settings)
- Matte adjustments
- Proc amp, color corrector, and legalizer settings

- Active Format Descriptor (AFD) settings
- Caption translation selection
- SD line 21 blanking selection
- Test pattern selection

VIDEO OUTPUT Displays the Output Menu Group, which selects which Video Processor output feeds the various FS1-X output connectors:

- Video output selections
- SDI and Fiber 3G output configuration

AUDIO PROC Displays the Audio Processor Menu Group, used to control the adjustable audio parameters:

- Audio level, phase, and delay settings
- Embedded audio out settings
- 5.1 and 7.1 Mix Down adjustments

AUDIO OUTPUT Displays the Audio Output Menu Group, used to control the routing of the audio sources

- Audio source selections
- Global output selection
- Output mapping controls

Control Knobs

These are the general rules of *SELECT* and *ADJUST* knob operation:

SELECT Turning the SELECT knob performs these actions:

- Turn *SELECT* in either direction to scroll through the menus.
- Stop on a menu to enter that menu for editing.
- Turn *SELECT* within a menu to scroll through multiple parameters.
- Pause on a parameter to select it for editing. For multiple fields in a parameter, use *SELECT* to move through the fields (after pressing *ADJUST* to enter field editing mode).
- Push *SELECT* momentarily to undo and restore the previous setting.

ADJUST Turning the ADJUST knob performs these actions:

- Turn *ADJUST* to change the values of a selected parameter.
- In most cases, leaving a value in place for a moment sets that value.
- To perform special actions, such as recalling a register, push the knob to confirm the displayed value. Display line 4 indicates such special actions.
- Some parameters having multiple fields, such as *IP Address* require you to push the *ADJUST* knob to select a field, and push again to save changes.

- Hold down the knob to reset a value to the factory default; for multiple field values, *all fields are reset to the default.*

Table 1. SELECT and ADJUST Knob Operation Summary

Function	Knob Action
Scroll through menus. Scroll through parameters in a multiparameter menu. Scroll through numerals or letters in a parameter.	Turn <i>SELECT</i> backwards or forward.
Enter edit mode for a menu. Enter edit mode for a parameter. Enter edit mode for values, numerals, or letters. Advance to the next value, numeral, or character to edit.	Turn and stop <i>SELECT</i> on the item to edit. (For some multiple parameter menus, push <i>ADJUST</i> so that the selected parameter blinks.)
Increment/decrement a value.	Turn <i>ADJUST</i> .
Coarse adjust a value.	10x speed - Hold down button (turns blue) and turn <i>ADJUST</i> . - or - 100x speed - Hold down button (turns blue), momentarily release and press button again (turns light blue) and turn <i>ADJUST</i> .
Reset a value to the factory default value. Set a number to the default value (typically zero). Set a letter to a default value (typically space).	Hold down <i>ADJUST</i> .
Take (commit) a change to an edited parameter.	Automatic after a few seconds for most parameters. For multiple field parameters, push <i>ADJUST</i> momentarily to save.
Abandon (undo) a change before committing.	Push <i>SELECT</i> momentarily.
Take (commit) a special action, such as a preset recall.	Push <i>ADJUST</i> momentarily.

LED Indicators

Indicators on the front panel are multi-state LEDs that light when a condition is present. They are conveniently arranged in groups to show specific subjects. For example, indicators for the two video processors are aligned in two columns with 1 and 2 labeling the tops of the columns.

The indicators and the conditions that cause them to light are as follows:

- REMOTE** A multicolor LED that indicates the current control mode:
- Green = Local Only (front panel control only)
 - Red = Remote Only (remote browser or panel control only)
 - Amber = Local + Remote (front panel and remote control both enabled)

VID IN 1/2 (blue) An active video input signal is detected for Channel 1 or 2.

UFC (blue) The Universal Format Converter has been changed from the default setting.

PROC AMP (blue) The Proc Amp has been changed from the default setting (it's no longer at unity).

FMT ERR 1/2 (blue) The selected input and output formats are incompatible for Channel 1 or Channel 2.

FRC PRES (blue) Frame Rate Converter option is present.

NOTE: The Frame Rate Converter option for FS1-X is no longer available from AJA.

- FRC ACTIVE (blue)** Frame Rate Converter is actively converting frame rates.
- REF (blue)** The REF connector has an external reference video source applied.
- KEYER (blue)** Reserved for future use.
- LAN (blue)** The FS1-X is connected to an operational local area network. This indicator lights momentarily when web browser selections are changed.
- EXT (blue flashing)** Flashes when a remote control source (remote panel or GPI) has initiated a change in the system.
- PWR 1/2 (blue)** Power Supply 1 or 2 is operational and receiving power. Both PWR 1 and PWR 2 LEDs must be lit to indicate redundant power is available.
- ID (blue blinking)** Blinks on and off when you right-click on an FS1-X system name and choose Identify in the web interface Network list. This action helps identify which FS1-X you're controlling when multiple FS1-X units are operated from a single computer. The ID LEDs on the front and rear panels perform the exact same function. No matter which side of a rack you're facing, you'll be able to see one of the LEDs.
- ALARM (red)** An alarm event has been detected. Press the STATUS button for information. The Alarm LED may light because of a disconnected or failed power supply, other hardware failure, video incompatibilities, or genlock loss. (Any of these conditions may be suppressed using the Alarm Suppress parameters.)

Incompatibility Alarms

The FS1-X produces signal incompatibility alarms for a number of reasons. For example, incompatible conversion alarms are possible when the FRC is not present or disabled (2 Channel operating mode). This is because in 2 Channel mode the FS1-X cannot convert between frame rate families (59.94/29.97/23.98, or 50/25, or 24).

Example Reference and Video Incompatibility Alarms Video incompatibilities that the FS1-X may detect include the following examples:?

Table 2. Video Incompatibility Examples

Video Incompatibility Detected	Alarm Status screen will show			Vid 1 Status screen will show		
Genlock Source is set to "Reference", but no Reference signal is detected. In this example the cable has been disconnected.	IN1	SDI 1	OK	IN1	SDI 1	525i59
	BKGD	Matte	OK	BKGD	Matte	
	GEN	Ref	No Ref	GEN	Ref	No Input
	OUT1		1080i59	OUT1		1080i59
Reference signal format is not compatible with selected Output Format. In this example the reference signal is 50 Hz but output is 59.94 Hz.	IN1	SDI 1	OK	IN1	SDI 1	525i59
	BKGD	Matte	OK	BKGD	Matte	
	GEN	Ref	No Ref	GEN	Ref	1080i50
	OUT		1080i59	OUT1		1080i59
Input signal is not compatible with the selected Output format. In this example the FRC is disabled, input is 525i59.94 and the output is 1080i50 (Web page example in Figure 4).	IN1	SDI 1	Incompat	IN1	SDI 1	525i59
	BKGD	Matte	OK	BKGD	Matte	
	GEN	Ref	OK	GEN	Ref	1080i50
	OUT		1080i50	OUT1		1080i50

Figure 4. Web page example of un-supported signals alarm.

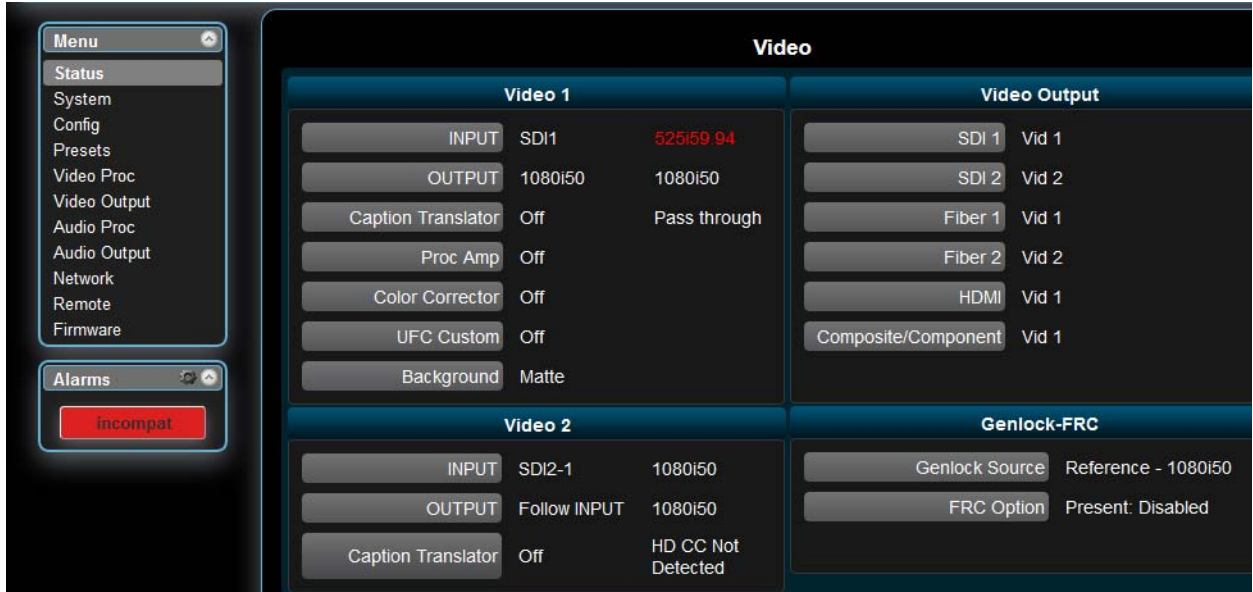

Rear Panel Description

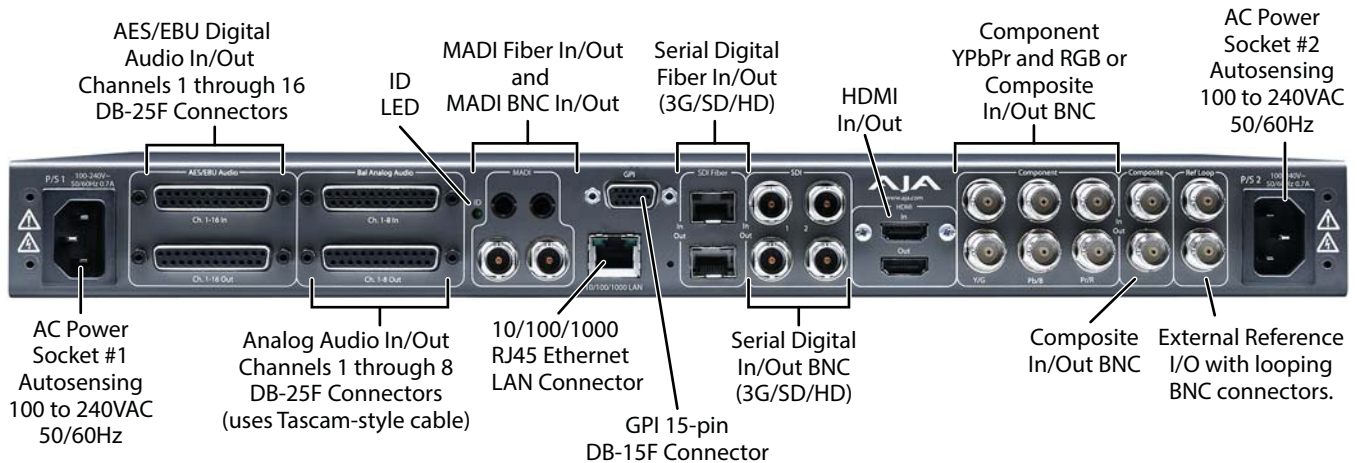

Connectors

The rear panel connectors are summarized below and described in detail in the next section:

P/S 1 and P/S 2 Two 3-pin grounded connectors provide AC power to the two independent power supplies. The supplies are autosensing for 100–240 VAC, 50/60 Hz. Only one connection is required for operation, but both connectors must be plugged into AC power for redundant power protection.

AES/EBU Digital Audio 16-Channel, 24-bit AES Input and Output on separate DB-25 connectors (Tascam pinout, see [“Audio Connection Pinouts” on page 119](#)).

Analog Audio Ch.1-8 In/Out 8 channel Balanced Analog Audio Input and Output on separate DB-25 connectors (Tascam pinout, see [“Audio Connection Pinouts” on page 119](#)). Audio A/D and D/A converters are 24 bit.

	Caution! Do not connect audio signals carrying phantom power to the FS1-X analog audio connectors.
---	--

MADI Fiber 64 channel MADI input and output, on separate Multi-Mode fiber connectors.

MADI BNC 64 channel MADI input and output, on separate BNC connectors.

GPI The GPI DB-15 connector provides connection to external equipment or circuits via an isolated TTL-compatible interface. Four GPI inputs and four outputs are available. See [“GPI Pinouts” on page 118](#).

Using the *REMOTE* menu group, you can program the actions of the GPI inputs and outputs individually. Contact closures on the inputs can trigger a wide variety of FS1-X functions. Alarms or loss of video can trigger the GPI outputs.

10/100/1000 LAN This RJ45 connector provides an Ethernet 10/100/1000 port for connection directly to a computer or to a LAN through an Ethernet hub or switch.

SDI Fiber In/Out (optional) Two optional Single-Mode Optical Fiber SFP modules support single- or dual-channel Fiber Input and/or Output. 3G/HD/SD SDI protocol is supported. Only AJA Optical Fiber SFP modules are supported—use of other manufacturer’s modules is not supported and may void warranty.

SDI In/Out Digital video with embedded audio. Two SDI input and two SDI Output BNCs. 10 bit 3G/HD/SD SDI is supported.

HDMI In/Out HDMI In and Out is supported on HDMI connectors. Standard SD and HD video formats are supported, including support for 8 channel embedded audio. Also supports standard computer DVI video formats (input via a DVI to HDMI cable). HDCP (copy protected) HDMI video is not supported.

Component In/Out YPbPr/RGB Video Component Analog Video is supported on 3x BNCs for Input and Output. Video A/D and D/A converters are 12-bit and support both SD and HD. YPbPr format is supported or the outputs can be switched to RGB.

NOTE: Unlike the other connectors, the set of three Component input connectors and the single Composite analog video input connector cannot be used simultaneously. You can choose either Component or Composite input, but not both. The same source video is also sent to both sets of analog video outputs.

Composite In/Out Composite NTSC or PAL standard definition Input and Output. Composite Video A/D and D/A converters are 12-bit.

Ref Loop The Reference Loop BNCs accept an Output timing reference signal. The reference can be SD Blackburst or HD tri-level sync. Examples of permissible reference video input signals:

- 525 Color Black
- 625 Color Black
- 1080i Tri-level Sync
- 720p Tri-level Sync

The 2 BNCs are a passive loop: one BNC is for the Input, and the remaining BNC can be connected to another piece of equipment in the reference chain or terminated.

NOTE: For proper operation the input Reference signal must be stable and properly terminated using a 75-ohm terminator on either the unused loop connector or the last piece of downstream equipment to which the Ref Video is connected.

Chapter 3: Installation & Configuration

Installation Overview

The installation and set up of an FS1-X is very simple. Plug both AC supply cords into AC mains power (separate branch circuits for redundancy), connect the LAN connector to a LAN, WAN or local computer with a web-browser, and then connect source and destination video and audio equipment.

NOTE: The AJA FS1-X should be plugged into 3-wire 100-240 VAC 50/60 Hz power (autosensing) before you make connections to other equipment. The AC cords provide a path to ground for accidental static discharge to protect system equipment. The FS1-X has two fully independent and redundant power supplies and will operate with one or both AC power cords plugged into the unit. However, fault-tolerance exists only if both power supplies are connected and plugged into separate branch circuits. Then if power is lost on a branch or one of the supplies, the FS1-X will continue to operate on the remaining circuit and power supply.



Warning!

To meet safety regulations for leakage current and to ensure redundancy in the event that a branch circuit breaker shuts off a branch, connect the FS1-X dual power supplies to separate branch circuits.

Installation Summary

All the steps of installation and configuration are documented in this chapter and are summarized as follows:

1. Unpack the shipping box, removing the FS1-X and two power cords.
2. Install any physical options, such as fiber optic I/O modules or Dolby I/O cards.
3. Mount the physical chassis as desired: front rack, rear rack, or desk mount. If you are mounting multiple FS1-X units, try to place them visually in the same area so you can use an attached computer to turn on and see the *ID* LED of the FS1-X you're communicating with. For physical installation details, see ["FS1-X Chassis Installation" on page 29](#).
4. Connect the two FS1-X power cords to mains AC. For redundancy, use both power supplies and connect them to separate branch circuits so that the FS1-X will continue to operate even if a circuit breaker opens on one branch.
5. If you plan to use remote control, connect your computer to the FS1-X directly using an Ethernet cable, or connect both the computer and the FS1-X to a local area network through an appropriate hub or router. Also set the FS1-X IP address in the menus, and then use a computer to test (ping) the FS1-X over the network connection to verify communication. For details, see ["Networking" on page 30](#).
6. Install a web browser on the computer, if not already present, for accessing the FS1-X web pages. You can access the pages simply by entering the FS1-X IP address in the browser address field. See ["Web Browser Control" on page 34](#) for details.
7. Connect the FS1-X to system audio and video sources, including VTRs, monitors, DVD players, video switchers, and audio mixers. For details, see ["System Cabling" on page 36](#).
8. Test the FS1-X with all of your devices to verify everything is working.

Unpacking

Shipping Box Contents

An FS1-X chassis is shipped with two AC power cords, a user manual CD, and any late-breaking news bulletins (if applicable). Chassis rackmount brackets are provided as part of the chassis with screws.

Figure 5. Shipping Box Contents

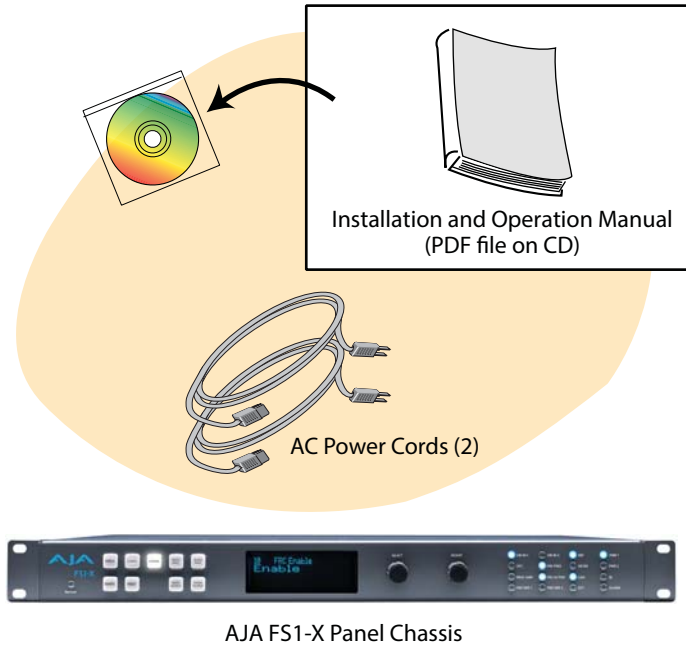

As you unpack the shipping box, carefully examine the contents. Ensure you received everything and that nothing was damaged during shipment. If you find any damage, immediately notify the shipping service and supply them with a complete description of the damage. AJA will repair or replace damaged items.

If you find shipping damage, contact your AJA dealer or distributor for details on how to have your FS1-X repaired or replaced.

NOTE: *Save packing materials and the shipping box. If your FS1-X ever requires service or you move your system, use the packaging materials and box for safe shipment.*

Installing Optional Fiber Optic I/O Modules

The optional AJA Fiber Optic I/O modules are purchased separately from the FS1-X. These AJA fiber modules work with the FS1-X:

- Single-channel LC connector modules
- Single-channel SC connector modules
- Dual-channel LC connector modules

**Caution!**

Only AJA fiber optic I/O option modules may be inserted into the FS1-X Fiber slots. DO NOT USE fiber modules from other manufacturers; they will damage the FS1-X connectors and circuits.

Install the optional fiber I/O modules by inserting them into the rectangular holes marked *Fiber* on the back panel with the electrical connectors facing downward. Press gently but firmly until the modules seat in the inside connectors. For additional installation and operation details, see the instructions provided with the fiber modules.

FS1-X Chassis Installation

The following information will help you install the FS1-X chassis correctly.

Physical Requirements for Mounting the Chassis

You can mount the FS1-X chassis in two ways:

- Rackmounting—attach the FS1-X (rear or front mounted) to a standard 19-inch wide equipment rack. The chassis occupies only one vertical rack unit.
- Desktop—lay it on a horizontal flat surface.

Chassis Dimensions

When planning the equipment location, consider the chassis dimensions:

- Height—1 rack unit, 1.75 inches (4.5 cm)
- Depth—16 inches (40.65 cm)
- Width—17.5 inches (44.45cm)
- Weight—7.85 pounds, 3.56 kilograms

Cabling and Cooling Requirements

Observe these precautions when placing your FS1-X:

- Plan adequate space for cable routing from the back of the chassis. Ensure that cable connectors are not stressed and cables are not bent or crimped.
- When rack mounting or stacking multiple FS1-X chassis, ensure adequate airspace for cooling around the FS1-X units. Note the location of cooling vents on all equipment next to the FS1-X and ensure none are obstructed.

NOTE: FS1-X units can be stacked vertically without limit as long as there is an adequate supply of cool air around the FS1-X vents.

Power Requirements

The FS1-X requires the following input voltage and power.

- Input Voltage—Chassis: autosensing 100VAC to 240VAC, 50/60Hz, fully redundant with both power supplies diode isolated.
- Power Consumption—55 Watts, 60 Watts with FRC option (70 Watts maximum)

Networking

You can network the FS1-X directly to a laptop or other desktop computer using a single Ethernet cable (straight or cross-over), or connect it to a local area network (LAN). In either case, the FS1-X connects via its 10/100/1000 Base-TX Ethernet connector. A LAN is a shared network that includes other Ethernet devices all attached via a hub or digital switch. LANs may be divided into zones separated by software or hardware routers. Routers may also be used to connect the LAN to an outside wide area network (WAN) such as the internet.

Devices on a LAN have IP addresses which may be fixed and permanent or dynamically assigned by the network (DHCP). When attaching the FS1-X to a LAN, talk to your network administrator to find out how they want it connected (static IP or DHCP). Your IT department will be able to supply the information you need to install the FS1-X on a LAN.

The following illustration shows a network connection example; your installation may differ.

Figure 6. Network Example, Two FS1-Xs on a LAN, with Laptop for Remote Control

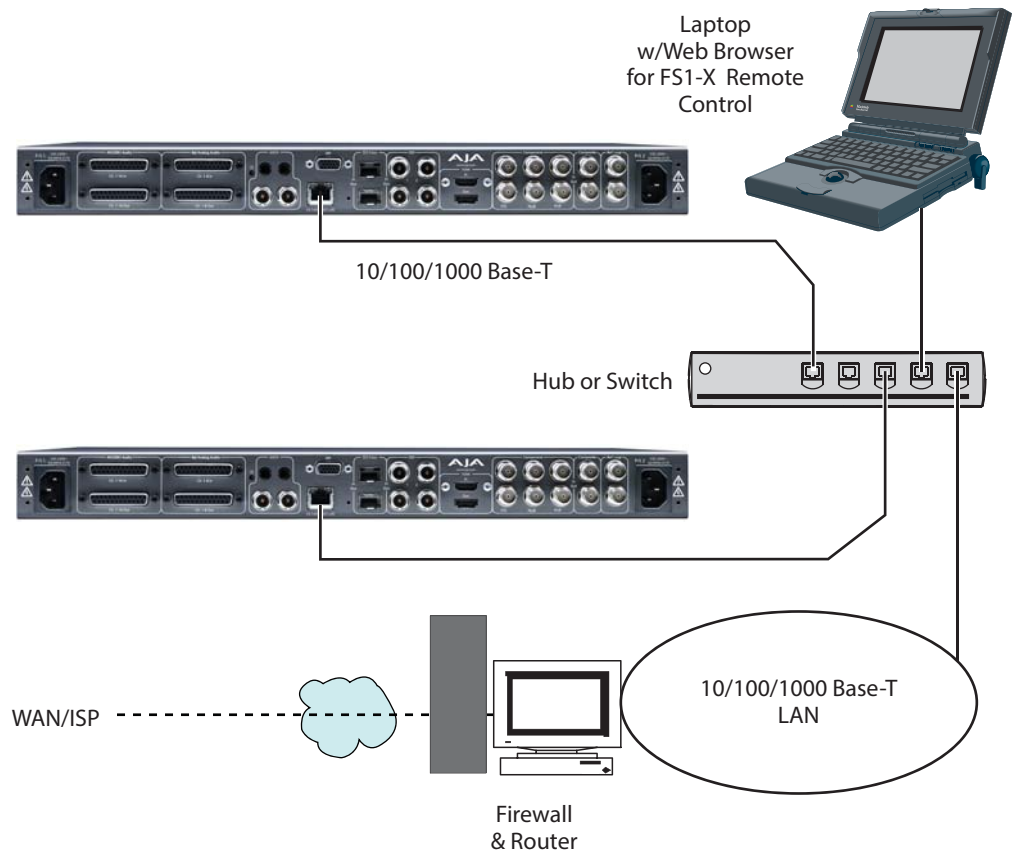

FS1-X Default Network Settings

The FS1-X ships from the factory set for DHCP networking, and can be manually reset to the following default network settings:

IP Address	192.168.0.2
Subnet Mask	255.255.255.0
Gateway	192.168.0.1

The following topics discuss two ways to set up the FS1-X to communicate over a TCP/IP network connection: via DHCP or via a static IP address.

Networking Using DHCP or Default Static IP

The FS1-X factory default configuration automatically looks for a DHCP server to issue an IP address. If your network includes a DHCP server, plug the FS1-X into the network and connect with the FS1-X as follows:

1. Press the *CONFIG* button.
2. Turn the *SELECT* knob to navigate to config parameter 2.2. Note on a piece of paper the DHCP-supplied IP address shown.
3. With your laptop or desktop computer connected to the same LAN as the FS1-X and DHCP enabled, type the IP address you noted into the browser address field and press *Enter*. You should now see the FS1-X's browser *Status* screen.

If the FS1-X cannot get an address from the network DHCP server, the FS1-X will automatically use a preset factory static IP address of 192.168.0.2. You can access the FS1-X using the default static address as follows:

1. Set your computer's IP address to whatever address you prefer.
2. Set the computer's Subnet mask to 255.255.255.0 (most PCs default to the proper netmask when the address is set).
3. Set the gateway address, if used, to match the FS1-X default: 192.168.0.1. Alternatively, change the FS1-X gateway address to match your gateway:
 - A. Press *CONFIG*, turn *SELECT* to 2.4 *Default Gateway*, push and then turn *ADJUST* to change the first group of digits.
 - B. Turn *SELECT* to advance to the next set of numbers, and turn *ADJUST* to set these numbers.
 - C. Continue using *SELECT* and *ADJUST* to set the full address.
 - D. When finished, push *ADJUST* momentarily to save the address.
4. Run a browser on the computer and type "192.168.0.2" (the factory static IP address). You should now see the FS1-X's browser status screen.

When you can access the FS1-X screens, see "[Browser Remote Control](#)" on page 91 for details about configuring the FS1-X using a browser.

Networking the FS1-X Using Your Own Static IP

If you don't want to use DHCP or the default static IP address, you can set your own static IP address:

1. Select the *CONFIG* button and use the *SELECT* knob to navigate to parameter 2.1 *IP CONFIG*. Use the *ADJUST* knob to select *Static*.
2. Turn *SELECT* to navigate to parameter 2.2 *IP ADDRESS*. The display shows the default static IP address: 192.168.0.2.

3. Change the IP address as follows.
 - A. Push the *ADJUST* knob momentarily so that the first octet (set of numbers) blinks, and then turn *ADJUST* to change the numbers.
 - B. Turn *SELECT* to advance to the next set of numbers, and turn *ADJUST* to set these numbers.
 - C. Continue using *SELECT* and *ADJUST* to set the full address.
 - D. When finished, push *ADJUST* momentarily to save the address.
4. Turn *SELECT* to advance to *2.3 Subnet Mask*. Use the *SELECT* and *ADJUST* knobs as in the previous step to set the desired subnet mask.
5. Turn *SELECT* to advance to *2.4 Default Gateway*. Use the *SELECT* and *ADJUST* knobs as in the previous step to set the desired gateway address.
6. Run a browser on the computer and type in the IP address you set for the FS1-X. You should now see the FS1-X's *Status* screen.

When you can access the FS1-X screens, turn to ["Browser Remote Control" on page 91](#) for details about configuring the FS1-X using a browser.

Figure 7. Setting FS1-X Static IP Address

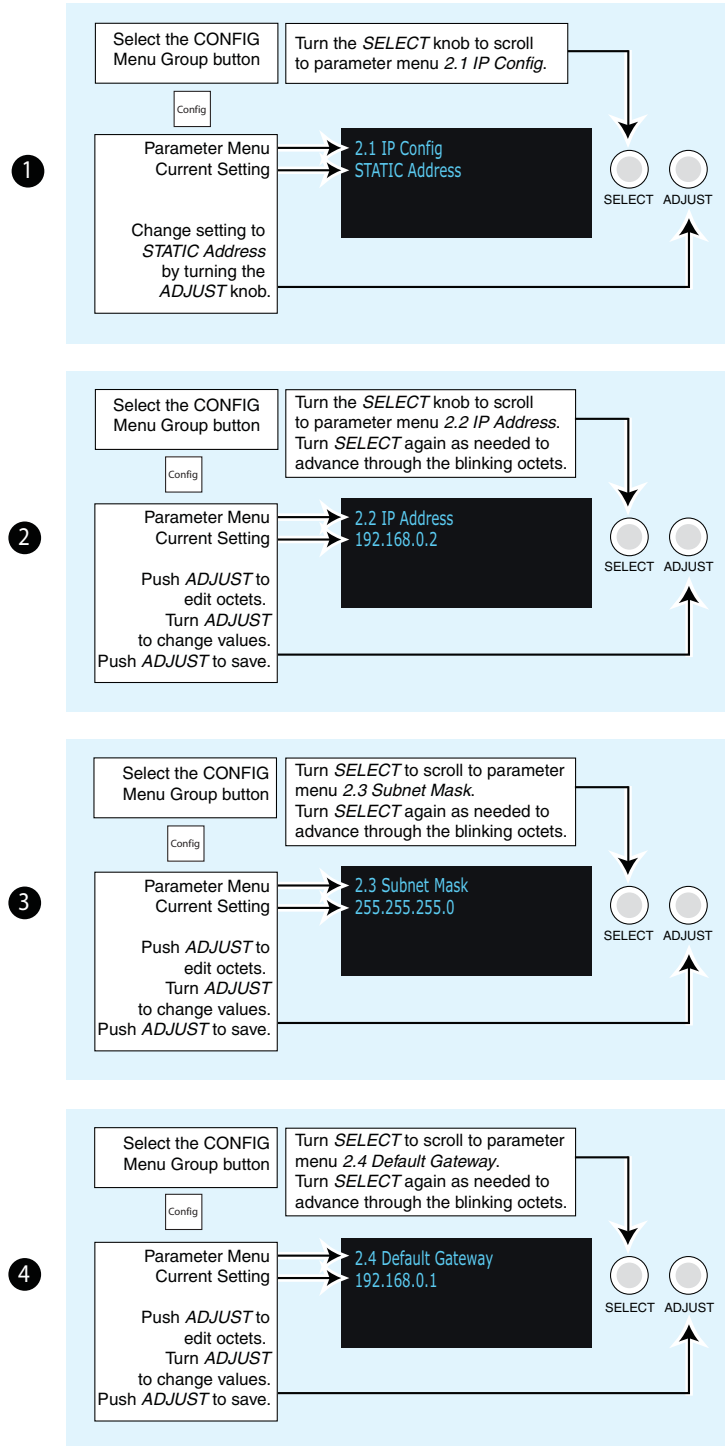

Using Ping to Test the Network Connection

If you have connected the FS1-X to a computer and set up the IP address and still do not see the FS1-X screens in your browser, you can ping the network to verify the connection. Simply run the Ping utility from a Mac OS X or Windows PC computer attached directly or on the same LAN as the FS1-X as described below:

Mac Ping Procedure

1. Find the Utilities Folder inside of the Applications Folder.
2. Locate the "Terminal" utility application and double-click it.
3. On the FS1-X, select the *CONFIG* button and go to parameter menu 2.2 to read the IP address.
4. At the Mac terminal prompt, enter *ping* and the IP address noted in step 3.
For example: ping 192.168.0.2
5. If successful, the ping utility will respond that packets were sent, received and how long it took. For example:
64 bytes from 192.168.0.2: icmp_seq=0 ttl=64 time=0.590 ms
6. If unsuccessful, check the FS1-X network settings and resolve the problem with your IT administrator.

Windows PC Ping Procedure

1. From the Start button, select the All Programs menu.
2. Select Accessories/Command Prompt from the All Programs list.
3. On the FS1-X, select the *CONFIG* button and go to parameter menu 2.2 to read the IP address.
4. In the PC *Command Prompt* utility, enter *ping* and the IP address noted in step 3. For example: ping 192.168.0.2
5. If successful, the ping utility will respond that packets were sent, received and how long it took. For example:
64 bytes from 192.168.0.2: icmp_seq=0 ttl=64 time=0.590 ms
6. If unsuccessful, check the FS1-X network settings and resolve the problem with your IT administrator.

Web Browser Control

To control the FS1-X from a web browser on a network attached computer, enter the FS1-X IP address as a URL in the browser. For example, if the FS1-X IP address were "90.0.6.31", you would then type into the web browser: <http://90.0.6.31>. This topic is explained in greater detail in *Chapter 5: Browser Remote Control*.

NOTE: *The webUI (browser GUI) will keep up with most changes initiated at the front panel. However, the webUI may not reconnect (displays "Disconnected") when network changes are initiated at the FS1-X front panel. To manually reconnect, type the new IP address into the browser, or click the browser Refresh button. Sometimes the browser caches the old FS1-X address. If you can't get the browser to connect, try clearing the Browser history to clear the cache, and then enter the new address again.*

Software Update Installation

Although the FS1-X comes from the factory pre-installed with software, it may not be as up-to-date as software posted on our AJA website. This topic describes the steps required to update the software in your AJA FS1-X.

Download the Latest Software

Current and past releases of FS1-X software are available on the World Wide Web from AJA's website. To get the software, point your browser to the FS1-X support page, which will contain helpful FS1-X information and links to the updates:

<http://www.aja.com/en/products/FS1-X#support>

Once you're at the update page, you can select FS1-X software files to download to your Mac or PC for upgrading your local FS1-X machine.

Unpack the Software

FS1-X software update files are "ZIP" files that you can open with a number of standard and third party file compression applications. The software image that you'll install on the FS1-X is a file with a name like `FS1-X_ver_1.0.0.0.bin` or similar.

NOTE: Depending on your PC or Mac operating system settings, the ".bin" extension may not be visible to you in a file directory.

Uploading and Installing the Software to the FS1-X

Uploading and installing the software update requires a PC or Mac that can "see" the FS1-X via its Ethernet connection. Follow this procedure to install the software:

1. Point your browser at the FS1-X's upgrade page by clicking on the *Update Firmware* link at the bottom of the navigation box on the left-hand side of any FS1-X web page. The FS1-X web pages are discussed in *Chapter 5*.

Figure 8. Update Firmware Browser Screen.

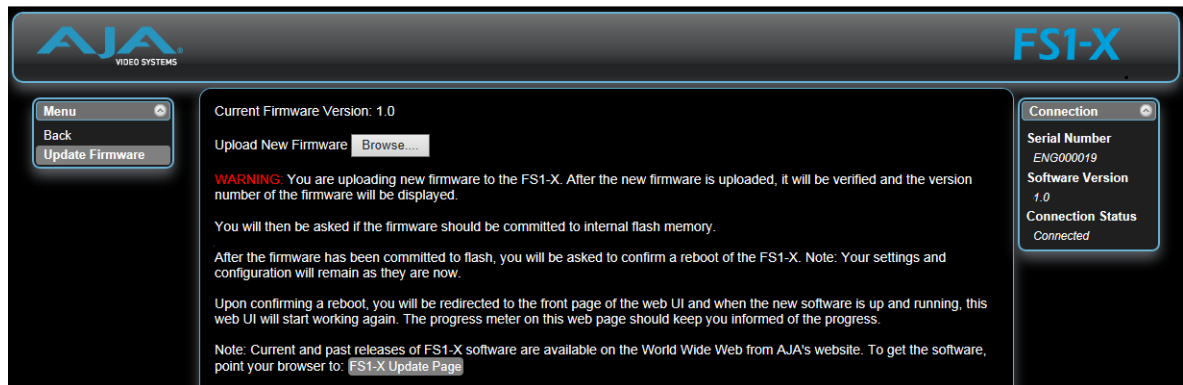

2. Click the *Browse...* button to find and select the downloaded file. For example: `FS1-X_ver_1.0.0.10.bin` contained in the file downloaded from AJA.
3. Click *OK* when asked if you want to *Upload Firmware*. The file uploads to the FS1-X and is tested for validity. Incomplete, corrupted, or non-FS1-X files are rejected. Wait for the procedure to complete—it will take only a few minutes. Progress bars show upload progress.
4. Click *Commit Uploaded Firmware* when prompted after the upload is finished. Progress bars show progress as the file is written to flash memory.
5. Click *Restart FS1-X with New Firmware* to restart the FS1-X. This will take the FS1-X offline for a minute or two. During the restart, progress is shown in the connection area in the upper right corner of the FS1-X *Status* screen. After restart, the FS1-X will be running the new software.
6. Once these steps are complete, the FS1-X will be running the software, and the *Software Version* on the *Status* screen shows the new version number. Check that the new software is running by bringing up the FS1-X web page again; the software version is displayed at the top of all FS1-X web screens. If the FS1-X did not update successfully, run through the update steps again.

NOTE: The configuration of the FS1-X prior to the upgrade is preserved. The unit returns to service exactly as it was before the upgrade.

If there is a power outage or glitch during the software download, the FS1-X will boot the older software version and you can restart the upgrade process. This happens because the FS1-X has been designed with a safety feature where an internal “safe” copy of the previous software is retained in the event the updating process fails.

System Cabling

System Video/Audio Cable Connections

When installing your system, you’ll make video and audio input/output connections. These connectors are explained individually in *Chapter 2*.

**Caution!**

Do not connect audio signals carrying phantom power to the FS1-X analog audio connectors.

GPI Connections

The FS1-X has four GPI inputs and four GPI outputs. The GPI inputs and outputs are electrically isolated from the power and ground on the FS1-X frame. Electrical isolation is provided for up to four pieces of external equipment.

See [“GPI Pinouts” on page 118](#) for information on how to wire the GPI connector to work with external devices that you want to use to control the FS1-X or that you want the FS1-X to control.

FS1-X Audio Level Choices—Pro or Consumer, US or EBU

Since the FS1-X handles both digital and analog audio and can convert between the two, it provides analog and digital audio level settings in the front panel menus and the remote web browser. Standard practice typically sets the maximum audio level approximately 20 db above the operating (alignment) level, allowing enough headroom to handle peaks without clipping. Because different countries and equipment types use different operating and maximum levels, the FS1-X has several audio level settings. These settings allow you to set the relationship between the analog and digital audio levels to accommodate the equipment and audio operating standards you use.

The FS1-X offers four settings shown in the following table. The analog audio levels listed in the table are defined in reference to 0 dBFS (where FS = full scale), which is the maximum level that can be represented digitally. Note that the test method for these levels uses a 1kHz sine wave.

Table 5. FS1-X Audio Level Settings

FS1-X Audio Setting	Meaning
+24 dBu analog = 0 dBFS maximum audio level	<p>SMPTE standard (US) With digital audio at the maximum possible level (before clipping), the expected analog audio input level is +24 dBu, and the output is scaled to this level.</p> <p>Typically, the US Standard Operating Level is +4 dBu analog or -20 dBFS digital. The FS1-X +24 dBu setting allows 20 dB of headroom (+4 to +24 dBu) per the SMPTE RP-155 standard.</p>
+18 dBu analog = 0 dBFS maximum audio level	<p>EBU standard (EU) With digital audio at the maximum possible level (before clipping), the expected analog audio input level is +18 dBu, and the output is scaled to this level.</p> <p>Typically, the EU Alignment Level is 0dBu analog or -18 dBFS digital. The FS1-X +18 dBu setting allows 18 dB of headroom (0 to +18 dBu) per the EBU R68 standard.</p>
+15 dBu analog = 0 dBFS maximum audio level	<p>German standard With digital audio at the maximum possible level (before clipping), the expected analog audio input level is +15 dBu, and the output is scaled to this level.</p>
+12 dBu analog = 0 dBFS. maximum audio level	<p>Consumer equipment With digital audio at the maximum level (before clipping), the analog audio input level is +12 dBu, and the output is scaled to this level. These levels are provided for consumer equipment that outputs lower audio levels than professional equipment.</p> <p>Consumer audio units are often given in dBV, with +12.2dBu equivalent to +10dBV. The standard operating level corresponds to -10dBV (-7.8dBu). The FS1-X +12dBu setting provides approximately 20 dB of headroom (+10 to -10 dBV).</p>

Stand Alone Tests

The stand alone tests can be performed without a computer, using the FS1-X front panel controls and rear connections.

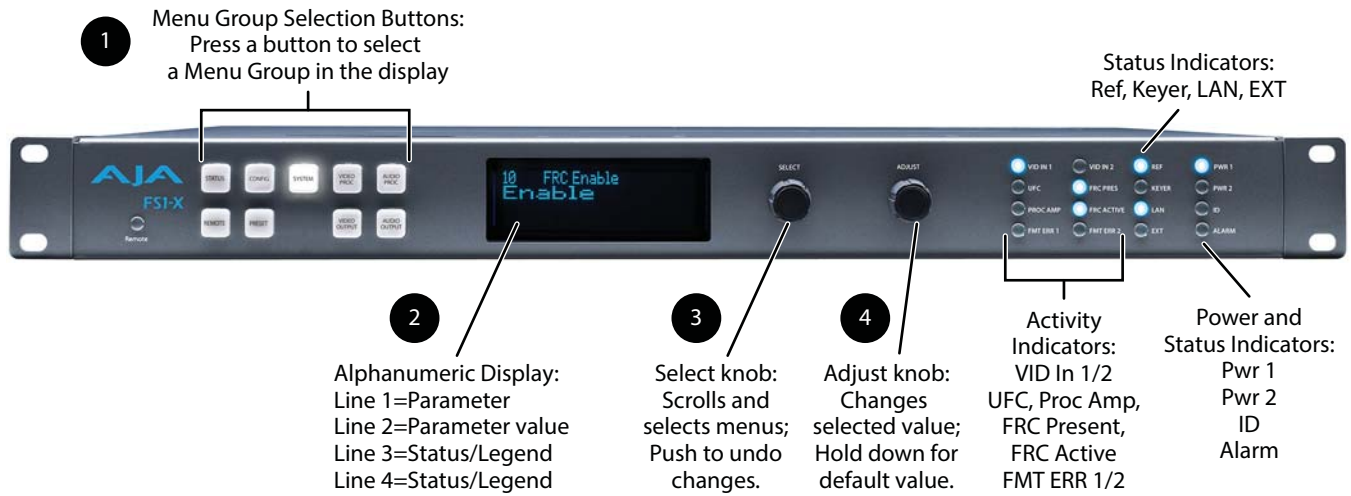

The following procedures assume the FS1-X is at factory defaults (taken from a newly opened box). If not set to defaults, the FS1-X may behave differently.

First Power Up

The following workflow powers up the FS1-X and demonstrates some example alarms.

- Setup**
- Ensure the FS1-X is completely disconnected (all video, audio, network, and power connector ports are empty).

- Procedure**
1. Connect both FS1-X power cords to mains AC and allow time for the unit to boot up. Observe the front panel LEDs.
 - If the FRC PRES LED lights blue, your FS1-X is equipped with the FRC option and is able to operate in either 1 Channel or 2 Channel Mode. If this LED is off, your unit can only operate in 2 Channel mode.
 - The ALARM LED will light red, indicating an alarm condition, and the REF LED will be off. By default the FS1-X is configured to operate genlocked to an external reference signal.
 2. Press the front panel *STATUS* button, then turn the *SELECT* knob to view various Status menus.
 - The Status menus will report No Input for the Video Processor video inputs (the ports are disconnected), and the *GEN* (Genlock) parameter will report *Ref* (configured for external reference) but will also report *No Input* or *No Ref*.

Vid 1 Format Status screen			Vid 1 Format Alarm Status screen		
IN1	SDI 1	No Input	IN1	SDI 1	OK
BKGD	Black		BKGD	Black	
GEN	Ref	No Input	GEN	Ref	No Ref
OUT1		525i59	OUT1		525i59

3. Connect a 525i color black reference signal to one of the FS1-X Ref Loop BNCs.

- The front panel ALARM LED will go off and the REF LED will light blue, indicating no alarm exists and the FS1-X is genlocked to an external reference signal.
- The Status menu *GEN* parameters will report *Ref* and indicate the format of the incoming reference signal or *OK*.

Vid 1 Format Status screen			Vid 1 Format Alarm Status screen		
IN1	SDI 1	No Input	IN1	SDI 1	OK
BKGD	Black		BKGD	Black	
GEN	Ref	525i59	GEN	Ref	OK
OUT1		525i59	OUT1		525i59

NOTE: If you connect a 625i25 frame rate color black reference signal, the alarm condition above persists because the default FS1-X output frame rate setting is 29.97/59.94. To clear this alarm when using 625i25 reference, press the *SYSTEM* button, turn the *SELECT* knob to 9 Output Frame Rates, and turn the *ADJUST* knob to choose 50/25.

4. Disconnect one of the power cords, leaving the other attached.
 - The ALARM LED will light red, and the PWR LED of the power supply with the removed cord will turn off.
5. Reconnect the power cable. The ALARM LED will turn off and the PWR LED will light.

This workflow confirms the FS1-X powers up successfully and reports reference and power supply alarms.

NOTE: FS1-X Reference, Power Supply, and Video Format alarms can be disabled, if desired,

Internal Test Signals to All Outputs

This workflow generates bars and tone and sends them to all the FS1-X outputs. This example uses the HDMI output connector for convenient monitoring, but any output can be used for that purpose. In the following procedures, where the terms *select* and *adjust* are used, turn the front panel *SELECT* and *ADJUST* knobs.

- Setup**
- Connect the FS1-X HDMI output connector to an HDMI display equipped with audio monitoring using a standard HDMI cable.

- Procedure**
1. Press the *VIDEO PROC* button.
 - Select 3 *Vid 1 Output Mode*, and adjust to *Test Pattern*.
 - Select 21 *Vid 1 Test Pattern* and adjust to *75% Bars*.
 2. Press the *VIDEO OUTPUT* button.
 - Select 1.2 *SDI2 Video Out* and adjust to *Vid 1*.
 - Select 2.2 *Fiber2 Video Out* and adjust to *Vid 1*.
 - Select 3 *HDMI Video Out* and adjust to *Vid 1*.
 3. Press the *AUDIO OUTPUT* button.
 - Select 11 *Global Audio Out* and adjust to *Sig Gen 1KHz*.

You should now be able to see and hear the test signals on the HDMI display, and on any other devices connected to the FS1-X outputs.

This workflow confirms the FS1-X generates and outputs video and audio.

FS1-X Processing Examples

In the following procedures, your exact actions depend on which FS1-X interface you are using. Where the terms *MENU NAME*, *select* and *adjust* are used:

- On the front panel interface, press the indicated Menu Group Selection button and then turn the *SELECT* and *ADJUST* knobs to choose the parameter and change the setting. The Front Panel menu numbers are included in the procedures.
- On the web browser interface, use your mouse to select the name of the Menu Screen and then choose the parameter and setting using the drop down list or slider. Menu numbers are not present on the FS1-X web pages.

SD to Sidebar HD over Matte

The following workflow demonstrates converting an SD SDI input to an HD SDI output with a matte sidebar background. If the input, reference, and output signal formats are all in the same frame rate family, this processing can be performed with or without the FRC option. This example uses a 525i59.94 input and generates a 1080i59.94 output.

- Setup**
- Ensure the FS1-X is receiving a valid reference signal.
 - Connect a 525i59.94 SD SDI signal to the SDI1 input on the rear of the FS1-X. Once connected the FS1-X front panel VID IN 1 LED will light.
 - Connect the FS1-X HDMI output connector to a compatible HDMI display.
 - Connect the FS1-X SDI1 video output connector to a compatible monitor.

NOTE: *The FS1-X factory default setting routes the output of Video Processor 1 to the SDI1, Fiber 1, HDMI, and Analog Video output connectors. All these outputs are active simultaneously.*

- Procedure**
1. **SYSTEM** menu:
 - Select *8 Genlock Source*, and adjust to *Reference*.
 - Select *9 Output Frame Rates*, and adjust to *59.94/23.98*.
 2. **VIDEO OUTPUT** menu:
 - Select *1.1 SDI 1 Video Out*, and adjust to *Video Proc 1*.
 - Select *3 HDMI Video Out* and adjust to *Video Proc 1*.
 3. **VIDEO PROC** menu:
 - Select *1.1 Video Input*, and adjust to *SDI 1*.
 - Select *2 Video Output Format*, and adjust to *1080i59.94*.
 - Select *3 Vid 1 Output Mode* and adjust to *Normal*.
 - Select *6 Background Fill* and adjust to *Matte*.
 - Select *7 Upconvert Mode* and adjust to *4x3 Pillar*.

You should now see the processed sidebar image on the SDI and HDMI monitors.

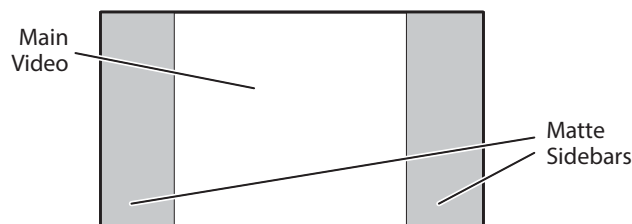

- Select *11.3 Matte Hue* and adjust to different degree settings. You should see the sidebar color hue change as you adjust.

This workflow confirms the FS1-X upconverts incoming video with matting.

HD to Letterbox SD over Video

The following workflow recalls the FS1-X to factory preset, downconverts a 1080i SDI input to 525i SDI letterbox, keys the letterbox over a second 525i SDI video input, and displays the result on the FS1-X Composite video output. This processing requires 2 Channel mode.

- Setup**
- Connect a 1080i59.94 HD SDI signal to the SDI1 input on the rear of the FS1-X. This signal will be downconverted and letterboxed.
 - Connect a 525i59.94 SD SDI signal to the SDI2 input on the rear of the FS1-X. This signal will be the background.
 - Ensure the FS1-X is receiving a valid reference signal compatible with the SDI2 input.
 - Connect the FS1-X Composite video output to an analog video monitor.

- Procedure**
1. *PRESET* menu:
 - Select *1.0 Factory Preset* and recall that preset.
 - Front panel interface: Push in the *ADJUST* knob momentarily.
 - Web page interface: Select *Factory Preset Recall*.

This recall sets the following default values for this procedure:

 - *SYSTEM 1.1 Vid 1 Input* is set to *SDI 1*
 - *SYSTEM 1.2 Vid 2 Input* is set to *SDI 2*
 - *SYSTEM 3 Vid 1 Output Mode* is set to *Normal*
 - *VIDEO OUTPUT 4 Analog* is set to *Vid 1*.
 2. If the FRC option is present, go to the *SYSTEM* menu:
 - Select *10 FRC Enable* and adjust to *Disable* (this sets 2 Channel mode). This menu is not available on FS1-X units lacking the FRC option.
 3. *VIDEO PROC* menu:
 - Select *2 Video Output Format*, and adjust to *525i59.94*.
 - Select *6 Background Fill*, and adjust to *Vid 2*.
 - Select *8 Downconvert Mode*, and adjust to *Letterbox*.

NOTE: *The H and V Output Timing settings of both Video Processor 1 and 2 must also be identical. The factory Preset recalls 0 values.*

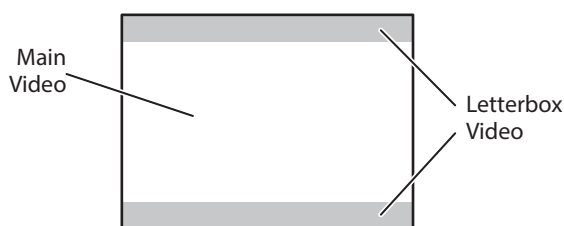

This workflow confirms the FS1-X downconverts incoming video to letterbox, and can key over another incoming video signal.

Conversion Across Frame Rate Families

The following workflow converts a 1080i59.94 SDI input to 1080i50 SDI output, using the optional FRC. This processing requires 1 Channel mode operation. In this example frame rate conversion with and without the FRC option is demonstrated.

- Setup**
- Ensure the FRC is installed. The front panel FRC PRES LED must be lighted blue. The FS1-X Status web page *FRC Option* setting must read *Present*. The web page may also report *Disabled*, which is the FRC's normal state when it is not actively converting video.
 - Ensure the FS1-X is using a valid reference. For this example, if an external reference signal is used for genlock it must be 50 Hz to match the frame rate converted output. Alternatively the FS1-X can be set to Free Run.
 - Connect a 1080i59.94 HD SDI signal to the SDI1 input on the rear of the FS1-X. This signal must be moving video (not a static test pattern) to properly demonstrate frame rate conversion.
 - Connect the FS1-X SDI1 video output connector to a compatible monitor.

- Procedure**
1. SYSTEM menu:
 - Select *8 Genlock Source*.
 - If your external genlock signal is 50 Hz, adjust to *Reference*.
 - Otherwise select *Free Run*.
 - Select *9 Output Frame Rates*, and adjust to *50/25*.
 - Select *10 FRC Enable* and adjust to *Enable* (this sets 1 Channel mode). The FRC ACTIVE LED will light blue because it is converting 59.94 Hz video to 50 Hz.
 2. Observe the monitor. Motion will be completely smooth without momentary jumps or discontinuities, and the FS1-X will not report any alarms.

To demonstrate non FRC operation and alarms, do the following:

3. SYSTEM menu:
 - Select *10 FRC Enable* and adjust to *Disable*. The FRC ACTIVE LED will go off and the ALARM LED will light red, because this conversion requires the FRC. FS1-X status reporting will be as shown below:

Vid 1 Format Status screen			Vid 1 Format Alarm Status screen		
IN1	SDI 1	1080i59.94	IN1	SDI 1	incompat
BKGD	Black		BKGD	Black	OK
GEN	Ref	1080i50	GEN	Ref	OK
OUT1		1080i50	OUT1		1080i50

Figure 9. FRC Option Present and Disabled Alarm Condition

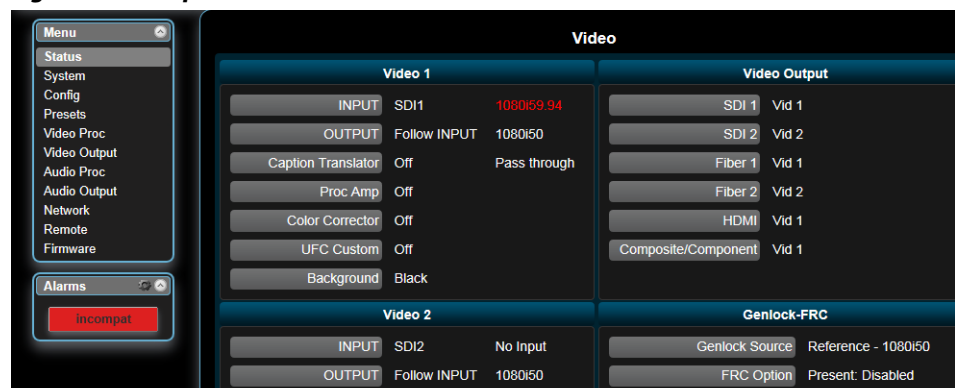

4. Observe the monitor. Motion will have momentary jumps, because the FS1-X is converting with add/drop frames instead of using the FRC.
5. SYSTEM menu:

- Select *10 FRC Enable* and adjust to *Enable* (this restores FRC operation).

Vid 1 Format Status screen (same)			Vid 1 Format Alarm Status screen		
IN1	SDI 1	1080i59.94	IN1	SDI 1	OK
BKGD	Black		BKGD	Black	OK
GEN	Ref	1080i50	GEN	Ref	OK
OUT1		1080i50	OUT1		1080i50

Figure 10. FRC Option Present and Active with No Alarm

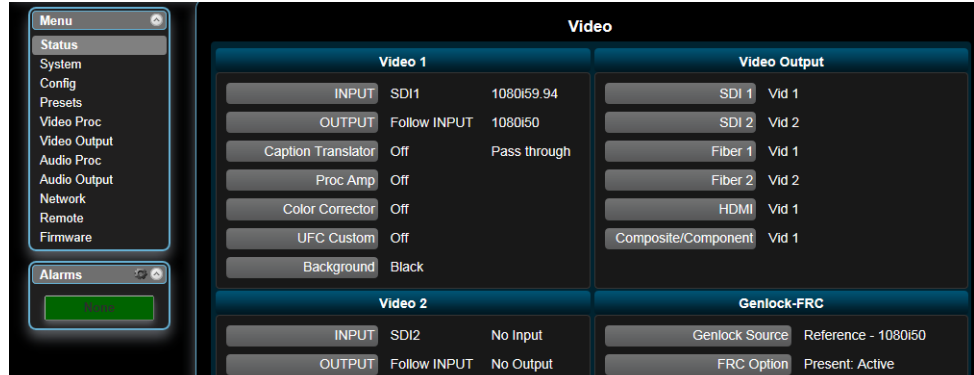

This workflow confirms an FS1-X equipped with the FRC option can frame rate convert between frame rate families.

Chapter 4: Display Menus

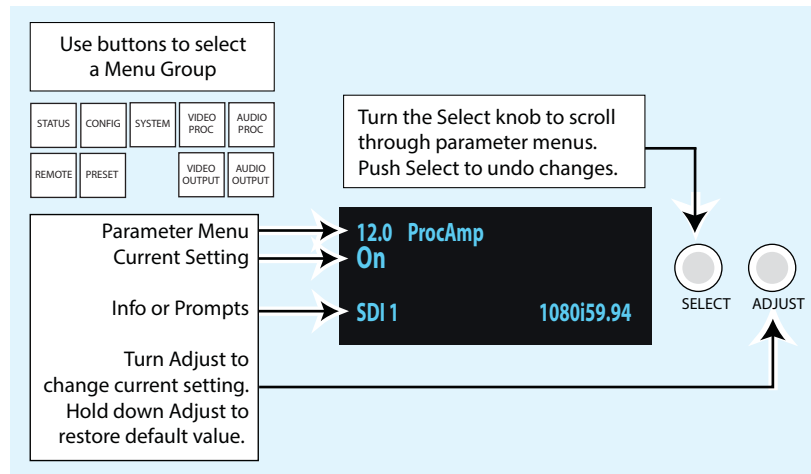

Overview

The FS1-X can be controlled in two different ways: (1) direct control using the front panel buttons, knobs, and display menus, (2) remote control using a web browser. This chapter describes the first, using the front panel controls, which is the most direct way to configure and use an FS1-X. The other method, using a computer, is described in the next chapter.

In *Chapter 2* we discussed the panel controls overall, so please read and understand that material first. In this chapter we discuss each of the Parameter Menus and their use. These are the topics covered:

- [“Menu Operation Examples” on page 45](#)
- [“STATUS Menu Group” on page 48](#)
- [“REMOTE Menu Group” on page 51](#)
- [“CONFIG Menu Group” on page 54](#)
- [“PRESET Menu Group” on page 58](#)
- [“SYSTEM Menu Group” on page 59](#)
- [“VIDEO PROC Menu Group” on page 64](#)
- [“VIDEO OUTPUT Menu Group” on page 81](#)
- [“AUDIO PROC Menu Group” on page 83](#)
- [“AUDIO OUTPUT Menu Group” on page 88](#)

Parameter Menus

The FS1-X display presents five major types of menu pages:

- Status pages—present status information that cannot be changed.
- Simple parameter menus—contain a parameter number and name on line 1 and its current value setting on line 2. The line 2 value can be changed using *SELECT* and *ADJUST*. Example: *Output Format*.
- “Take action” parameter menus—contain a parameter number and name on line 1, and the value to “take” on line 2. A “take” prompt may appear on line 3. The line 2 value can

be changed using *SELECT* and *ADJUST*, and the take or switch to the new value occurs when you press *ADJUST* momentarily. Examples: *Preset Save/Recall*.

- Multiple field parameter menus—contain a parameter number and name on line 1 and its current value setting on line 2, consisting of multiple letter or number fields that must each be set individually. The line 2 fields can be changed using *SELECT* and *ADJUST*. Example: *IP Address*.
- Hidden parameter menus—a “parent” menu exists that, when that parent parameter is turned on, can display “child” menus of related parameters. When the Hidden Menus parameter is set to Hide Inactive, these child menus are hidden when the parent parameter is off. Some menu names contain a decimal (dot) number and zero, which indicates there are a group of related parameters. Example: 12.0 ProcAmp is the parent menu of the 12.1 through 12.4 child menus.

Menu Operation Examples

The following examples demonstrate typical menu operation. After this section, each Menu Group is described in detail.

Status Pages These steps explain how to surf the *STATUS* menus.

1. Press the *STATUS* Menu Group button.
2. Turn the *SELECT* knob forward and backward to display the *Status* pages. The display scrolls through the pages as you turn the knob. The *Status* displays simply show the status of important FS1-X operational parameters.

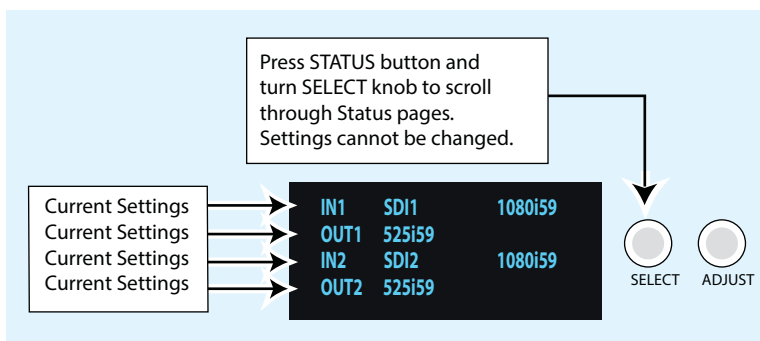

Simple Menus: Config Format Alarm Filters

These steps explain how to surf and change simple menus, such as the Power Supply Alarm Filters.

1. Press the *CONFIG* Menu Group button.

- Turn the *SELECT* knob to access menu *Power Supply Alarm*. The default alarm setting is *Normal*.

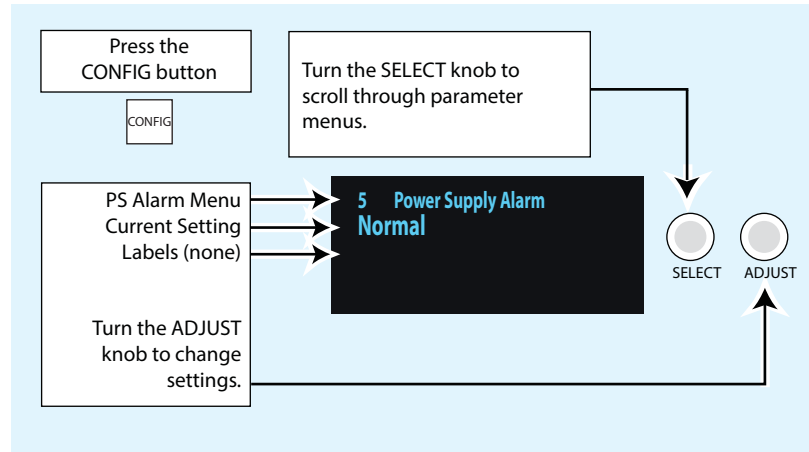

- Turn the *ADJUST* knob one click clockwise to change the setting to *Suppress*, which turns off the alarm so that it will never come on.
- Turn the *SELECT* knob clockwise again to access menu *Vid1 Format Alarm*.
- Now change the *Vid1* setting, using the *ADJUST* knob.
- Continue by turning *SELECT* to access the *Reference Alarm* setting. Change the settings using the *ADJUST* knob, if you wish.

Hidden Parameter Menus: Video ProcAmp

These steps explain how to surf and change hidden parameter menus, such as the *Video ProcAmp* settings.

- Press the *VIDEO PROC* Menu Group button.
- Turn the *SELECT* knob as necessary to display menu *ProcAmp*.
- Turn the *ADJUST* knob to change the value setting from *OFF* (default) to *ON*.

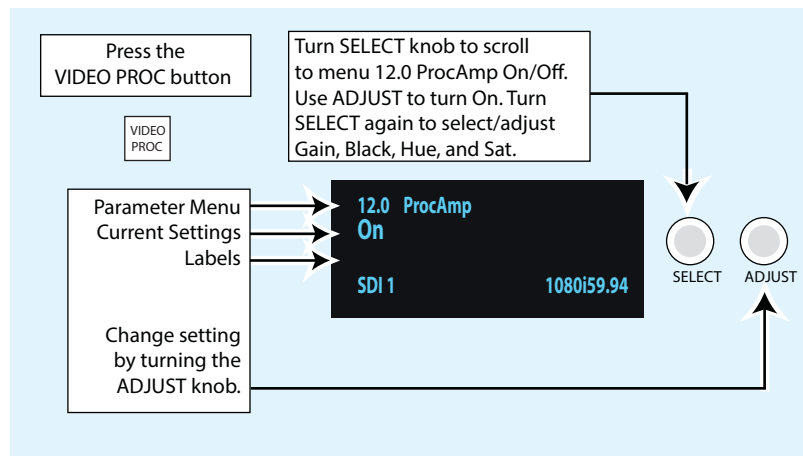

- Turn the *SELECT* knob clockwise to access menu *ProcAmp Gain* and set the Gain as desired using the *ADJUST* knob.
- Turn the *SELECT* knob one click clockwise to advance to the *ProcAmp Black* menu. Turn *ADJUST* to set the black level.
- Turn the *SELECT* knob clockwise again one click to advance to the *ProcAmp Hue* menu. Turn *ADJUST* to set the hue.

- Turn the *SELECT* knob clockwise again one click to advance to the *ProcAmp Sat* menu. Turn *ADJUST* to set the saturation.

Multiple Field Parameters: IP Address

These steps explain how to surf and change multiple field parameter menus, such as the *IP Address* settings, where there are multiple fields to set within the value.

- Press the *CONFIG* Menu Group button. The *Config* menus appear.
- Turn the *SELECT* knob clockwise to access the *IP Config* menu. Turn the *ADJUST* knob to change the setting to *Static Addr*. This setting allows you to manually set the IP address in the following steps.
- Turn the *SELECT* knob clockwise one click to access menu *IP Address*. The current IP address appears on the second line.
- Push the *ADJUST* knob momentarily to highlight the first field, which is the octet (group of numbers) to the left of the first period. The numbers blink to indicate they are ready for editing.
- Turn the *ADJUST* knob to change the blinking field value.
- Turn the *SELECT* knob to highlight the next field, a group of numbers to the right of the first period. The field will blink when they are ready for editing.
- Turn the *ADJUST* knob to change the blinking field value. For faster (10x) adjustment of wide-ranging values, hold down *CONFIG* and turn *ADJUST*.
- Repeat this process of selecting fields and changing them until all fields have been changed as desired.
- Push the *ADJUST* knob quickly to confirm all settings. Alternatively, you can scroll counterclockwise back through the fields, stopping on any of them to change them. They must be blinking before they can be changed.

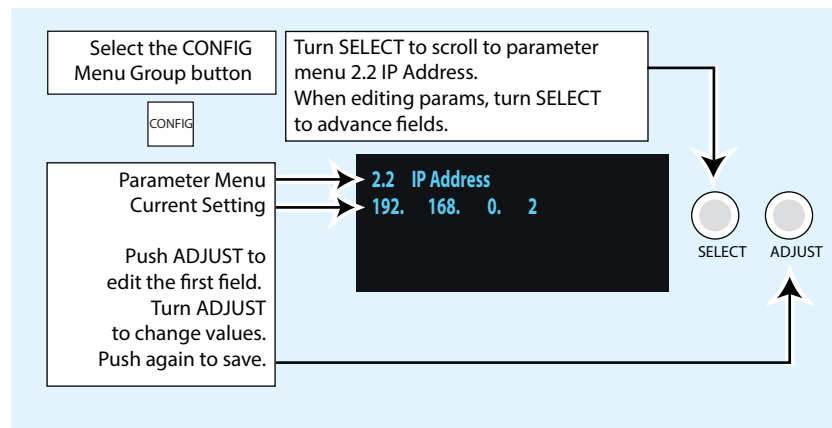

- Other Actions**
- To begin editing the first field in the parameter, push *ADJUST* momentarily.
 - To confirm (save) edits, push the *ADJUST* knob momentarily again. This saves the edits and exits the edit mode.
 - To undo edits to all of the fields before the changes are confirmed, push the *SELECT* knob. This returns all fields to their previous settings.
 - To reset the entire parameter to the factory default value, push in and hold down the *ADJUST* knob for at least 4 seconds.

Menu Parameter Interactions

Several FS1-X menus interact with one another, such that changing a parameter value in one menu may change the settings of another menu, change what settings are available in other menus, or cause settings that exist in other menus to be ignored. *Figure 11* shows some of these relationships.

Figure 11. FS1-X Menu Parameter Interactions

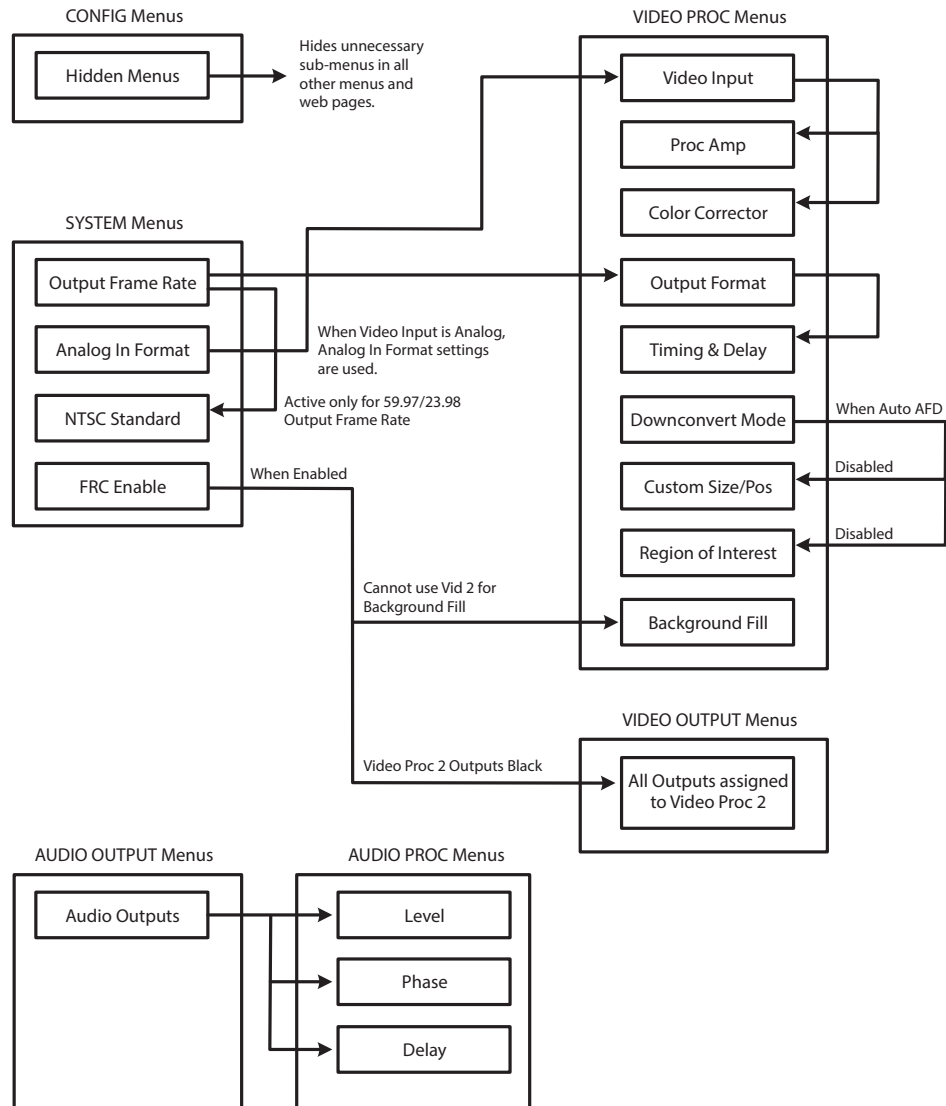

STATUS Menu Group

The *Status* Menu Group contains a series of *Status* display pages that you can scroll using the *SELECT* knob. The various *Status* pages are actually just displays, not menus, since they don't include menu numbers or editable values. The *ADJUST* knob doesn't affect the *Status* display pages.

When you press the *STATUS* button, the display shows the first menu unless there is an active alarm. If an alarm is active, the relevant alarm status page is displayed first. If more than one alarm is active, the highest priority alarm page is displayed first.

I/O Status

This menu shows the current primary settings for Video Processors 1 and 2.

Display	Description
IN1 Sel Video Format	Video Processor 1 selected video input and detected format.
OUT1 Sel Video	Video Processor 1 video output format.
IN2 Sel Video Format	Video Processor 2 selected video input and detected format.
OUT2 Sel Video	Video Processor 2 video output format.

Vid1 Format Status

This menu shows the current primary video settings for Video Processor 1.

Display	Description
IN1 Input Source Format	Selected Video Processor 1 video input source and format.
BKGD Backgd Source	Selected Background video source.
GEN Genlock SourceFormat	Selected Genlock source and format.
OUT1 Format	Selected Video Processor 1 output format.

Vid1 Format Alarm Status

This menu shows the Video Processor 1 alarm status. Absence of alarm shows as *OK*. If selections are incompatible, the status of the affected signal shows *incompat*.

Display	Description
IN1 Input Source Status	Selected Video Processor 1 video input source alarm status.
BKGD Backgd SourceStatus	Selected Background video source alarm status.
GEN Genlock SourceStatus	Selected Genlock source alarm status.
OUT1 Status	Selected Video Processor 1 output format/alarm status.

Vid2 Format Status

This menu shows the current primary video settings for Video Processor 2.

Display	Description
IN2 Input Source Format	Selected Video Processor 2 video input source and format.
GEN Genlock SourceFormat	Selected Genlock source and format.
OUT2 Format	Selected Video Processor 2 output format.

Vid 2 Format Alarm Status

This menu shows the Video Processor 2 alarm status. Absence of alarm shows as *OK*. If selections are incompatible, the status of the affected signal shows *incompat*.

Display	Description
IN2 Input Source Status	Video Processor 2 video input source alarm status.
GEN Genlock SourceStatus	Genlock source alarm status.
OUT2 Status	Video Processor 2 output format/alarm status.

Output Status

This menu shows the video processor selected for each of the video outputs.

Display	Description
SDI1 Selected Video Processor	Selected Processor feeding the SDI 1 output.
SDI2 Selected Video Processor	Selected Processor feeding the SDI 2 output.
Fiber1 Selected Video Processor	Selected Processor feeding the Fiber 1 output.
Fiber2 Selected Video Processor	Selected Processor feeding the Fiber 2 output.
HDMI Selected Video Processor	Selected Processor feeding the HDMI output.
Analog Selected Video Processor	Selected Processor feeding the Analog output.

Power/Temp Alarm

This menu shows the power supply status of the FS1-X and the temperature status. If a power supply is unplugged, the display top line indicates *PS OFF* or *PS Error*.

Display	Description
PS1 Alarm Status	Displays the state of the PS1 power supply (OK or ERROR).
PS2 Alarm Status	Displays the state of the PS 2 power supply (OK or ERROR).
TmpAlarm Status	Displays a temperature alarm if the FS1-X overheats.

Caption Status

This menu shows what type of closed caption data is selected and whether closed caption data is present on the selected video input.

Display	Description
VID1CC Caption Type & Presence	Video Processor 1 selected caption type (SD/HD/Invalid) and presence (Detected/Not detected/Pass through).
ViD2CC Caption Type & Presence	Video Processor 2 selected caption type (SD/HD/Invalid) and presence (detected/not detected/Pass through).

FRC Status

NOTE: The Frame Rate Converter option for FS1-X is no longer available from AJA.

This menu shows the status of the Frame Rate Converter. factory installed option. This menu is hidden if the FRC option is not present.

Display	Description
FRC Status	Indicates if the FRC option is installed (Present or Absent).
Mode Status	Displays the current state of the FRC (Enabled or Disabled, and Active or Bypass).
IN Source	Displays the FRC input source and format.
OUT Format	Displays the FRC output signal format

MADI Status

This menu shows the status of the MADI input and output channels.

Display	Description
BNC In Mode	Indicates the Mode (64 or 56 channels) and input signal
BNC Out Mode	Status of the MADI BNC ports.
FIB In Mode	Indicates the Mode (64 or 56 channels) and input signal
FIB Out Mode	Status of the MADI Fiber ports.

System Status

This menu shows the FS1-X's System Name, IP address and mask, and version number.

Display	Description
System Name	Displays the System Name as set in <i>Config</i> menu 1.
IP addr value	Shows the IP address.
IP Mask value	Shows the IP mask.
Version value	Shows the software version number.

NOTE: *The IP parameters shown here on the STATUS menu group System Status menu are the actual settings of the Ethernet interface, as read from the interface. The CONFIG menu group IP configuration parameters show the values the FS1-X is supposed to use to configure the interface (they are read from memory). If there is ever a discrepancy between the two, the STATUS screen is the more correct.*

REMOTE Menu Group

The *REMOTE* Menu Group lets you set up how you want the FS1-X to be controlled. Control options include the front panel, a remote computer running a browser, and GPI inputs and outputs.

NOTE: *The Remote Menu Group parameters available on the front panel interact with the browser parameters available on an attached computer, and vice versa. For example, the Remote Control parameter can only be changed from the front panel, and when set to Local Only will deactivate all browser remote control parameters.*

1 Remote Control

This parameter determines whether the FS1-X panel responds to controls locally from the front panel, from a network attached computer with a web browser, or both. The selected mode is indicated by the color of the *REMOTE* LED.

Local + Remote (default)	Control the FS1-X from the front panel, a remote control panel, or a network-attached browser. The <i>REMOTE</i> LED lights amber.
Local Only	Control the FS1-X only from the front panel (browsers cannot change parameters). The <i>REMOTE</i> LED lights green.
Remote Only	Control the FS1-X only from a network attached browser or remote control panel. The <i>REMOTE</i> LED lights red.

1.1 Authentication

This parameter enables or disables an authentication login requirement. By default this parameter is set to *Disabled*.

When you select *Login* via the front panel parameter, you must then go to the browser interface to perform a login each time you access the FS1-X. The browser presents the login screen first, requiring you to log in before you can access any other browser screens. The password is initially set to the default value, but you can change it using the Remote browser screen.

The default password is *password*.

NOTE: If authentication is used, it provides only a minimum security safeguard against unauthorized use of the FS1-X. The authentication mechanism is simple and does not provide robust security.

Disabled (<i>default</i>)	Disables the requirement for a login password. No password is needed.
Login	Login is required via the web browser interface before changes can be made in FS1-X. After selecting Login, depending on the browser a new browser window may be necessary (i.e. just a page refresh or reload may not get rid of the login page).

2.1–4 GPI IN 1–4 Response

The setting of this parameter determines what happens when a GPI trigger is received at the FS1-X's GPI Inputs (1–4). A GPI Trigger is defined as a TTL low voltage level (0 to 0.8V with respect to its isolated ground pin). The GPI interface pinout and specifications are

discussed in *"GPI Pinouts" on page 118*. Input video sources selected by GPI trigger remain selected until the trigger is released. GPI Inputs light the front panel EXT LED when triggered.

No Action (<i>default</i>)	Performs no action.
PRESET 1–10	Recalls the specified PRESET configuration.
Vid1 Freeze	Freezes the current Vid 1 video frame at its outputs. Freezing stops when the GPI trigger is released.
Vid1 SDI1 In	Selects SDI1 as the Vid1 video input.
Vid1 SDI2 In	Selects SDI2 as the Vid1 video input.
Vid1 SDI DLink	Selects Dual-Link mode for the Vid 1 SDI input.
Vid1 Fiber1 In	Selects Fiber1 as the Vid 1 video input.
Vid1 Fiber2 In	Selects Fiber2 as the Vid 1 video input.
Vid1 Fbr DLink	Selects Dual-Link mode for the Vid 1 Fiber input.
Vid1 HDMI In	Selects HDMI In as the Vid1 video input
Vid1 Cmpst In	Selects Composite In as the Vid1 video input.
Vid1 Cmpnt In	Selects Component In as the Vid1 video input.
Vid1 ARC Off	Turns Off SD to SD aspect ratio conversion.
Vid1 ARC LTBX	Converts 16:9 anamorphic video to letterbox.
Vid1 ARC H CP	Converts 16:9 anamorphic video to 4:3 standard (H crop—crops left and right edges of video).
Vid1 ARC PLBX	Converts 4:3 standard video to 16:9 anamorphic (pillarbox).
Vid1 ARC V CP	Converts letterbox video to 16:9 anamorphic (V crop).
Vid1 ARC 14x9	Converts 16:9 anamorphic video to 14:9 cropped.
Vid1 DC Crop	Downconverts HD source to cropped 4x3 picture.
Vid1 DC ANA	Downconverts HD source to anamorphic picture.
Vid1 DC 14x9	Downconverts HD source to 14x9 picture.
Vid1 DC Auto AFD	Downconverts HD source automatically using the best mode for the input video Active Format Description (AFD) code.
Vid1 DC LTBX	Downconverts HD source to letterbox picture.
Vid 1 DC Custom	Downconverts HD source to Custom size, position, and crop parameters.
Vid1 UC 4x3 PB	Upconverts SD source to 4x3 pillarbox.
Vid1 UC 14x9 PB	Upconverts SD source to 14x9 pillarbox.
Vid1 UC FLSCR	Upconverts SD source to full screen.
Vid1 UC LB FUL	Upconverts SD source from letterbox to full.
Vid1 UC WDZM	Upconverts SD source to a wide zoom.
Vid 1 UC Custom	Upconverts SD source to Custom size, position, and crop parameters
Vid2 Freeze	Freezes the current video frame at its outputs. Freezing stops when the GPI trigger is released.
Vid2 SDI1 In	Selects SDI1 as the Vid2 video input.
Vid2 SDI2 In	Selects SDI2 as the Vid2 video input.
Vid2 SDI DLink	Selects Dual-Link mode for the SDI input.
Vid2 Fiber1 In	Selects Fiber1 as the Vid2 video input.
Vid2 Fiber2 In	Selects Fiber2 as the Vid2 video input.
Vid2 Fbr DLink	Selects Dual-Link mode for the Vid2 Fiber input.
Vid2 HDMI In	Selects HDMI In as the Vid2 video input
Vid2 Cmpst In	Selects Composite In as the Vid2 video input.
Vid2 Cmpnt In	Selects Component In as the Vid2 video input.

3.1–4 GPI 1–4 OUT

The setting of this parameter determines whether certain FS1-X events will generate a GPI trigger output at GPI outputs 1, 2, 3, or 4. The GPI interface pinout is presented in “GPI Pinouts” on page 118.

No Action (<i>default</i>)	Does not trigger a GPI output regardless of event.
Alarm	Generates a GPI out trigger if an internal alarm condition occurs.
No Video 1	Generates a GPI out trigger if no video is detected at the input.
No Video 2	Generates a GPI out trigger if no video is detected at the input.
No Ref	Generates a GPI out trigger if no video is detected at the Ref input.

Interaction of Presets and GPIs

If you use a GPI input trigger to recall a preset, the recall changes the *GPI IN Response* setting to whatever *GPI IN Response* setting the preset contains. As the following examples explain, this feature offers both the power of serial recalls and the possibility of triggering a recall that changes *GPI IN Response* to something unintended.

Example of a Serial Recall

The advantage of using *GPI IN Response* with presets is that you can trigger a series or even a looping series of preset recalls. For example, suppose *GPI IN 1 Response* in Preset 1 is set to Preset 2, and *GPI IN Response* in Preset 2 is set to Preset 1. Triggering the GPI will toggle between the two presets.

Example of an Unintended Recall

Suppose you trigger *GPI IN 1* while the current *GPI IN 1 Response* parameter is set to Preset 1. This recalls Preset 1 as expected. However, suppose Preset 1 contains a stored *GPI IN 1 Response* setting of *No Action*. If you trigger GPI IN 1 later, expecting to recall Preset 1 again, the FS1-X instead performs *No Action*. To prevent unexpected changes in the *GPI IN Response* parameters, set these parameters as desired before storing presets; in the example, set *GPI IN 1* to Preset 1 before you store Preset 1.

CONFIG Menu Group

The *CONFIG* Menu Group includes parameters for setting up the FS1-X’s network, system name, SNMP, alarm, and screen saver configurations.

1 System Name

This parameter defines a unique name for the FS1-X. This same name is used both when displaying systems via the web interface and when displaying the FS1-X’s screen saver.

Variable	Set the system name, up to 20 characters. <i>Default:</i> aja-fs1-x
----------	---

Name Entry Procedure

Set the name as follows:

1. Push *ADJUST* momentarily to enter character editing mode.
2. Turn *SELECT* to advance the blinking cursor to each character.
3. Turn *ADJUST* to scroll through the choices for each character. These characters are allowed: A through Z (uppercase), a through z (lowercase), numerals, hyphen (-), period (.), and space (blank). Leave the desired character selected and advance to the next one.
4. Push *ADJUST* to save and activate the name after all characters are defined.
 - To abandon changes before saving, push *SELECT*.
 - To return to the default name at any time, hold down *ADJUST*.

NOTE: To eliminate trailing characters to shorten an existing system name, overwrite them with a hyphen (-) or space.

2.1 IP Config

This parameter determines the type of TCP/IP network configuration used by the FS1-X. Consult your network administrator about how to set this value.

DHCP (<i>default</i>)	Select automatic IP address assignment from the LAN DHCP server. If the FS1-X cannot find a DHCP server, it fails over to the static IP address.
Static Addr	Assign a static IP address manually (using the following parameter menus). The factory default static IP address: 192.168.0.2

2.2 IP Address

This parameter determines the static IP address used by the FS1-X for TCP/IP networking. Consult your network administrator about how to set this value.

IP Address variable	If <i>IP Config</i> is set to <i>DHCP</i> dynamic addressing (default), the IP Address is set automatically by the network's DHCP server. If <i>IP Config</i> is set to <i>Static Addr</i> , manually enter an IP address. If <i>IP Config</i> is set to <i>DHCP</i> and there is a DHCP failure, the IP address is set to the static IP address. The factory default static IP address is 192.168.0.2.
---------------------	---

Octet Value Entry Procedure

Set the octets (numbers between periods) values as follows:

1. Push *ADJUST* momentarily to enter edit mode.
2. Turn *SELECT* to select the octet you want to edit, indicated by blinking.
3. Turn *ADJUST* to enter the new value.
 - If you need to revert to the previous setting (undo changes), push *SELECT*.
4. Push *ADJUST* momentarily to save and activate the new setting.
 - If you want to revert to the default value, hold down *ADJUST* for 4 seconds.

2.3 Subnet Mask

This parameter determines the subnet mask used by the FS1-X for TCP/IP networking. Consult your network administrator about how to set this value.

Subnet Mask variable	Enter a subnet mask compatible with your LAN. This is only needed for Static IP configurations. If 2.1 is set to DHCP, the Subnet Mask is set by the DHCP server and cannot be changed by the user. If 2.1 is set to <i>Default Addr</i> , the default <i>Subnet Mask</i> is 255.255.255.0
----------------------	--

2.4 Default Gateway

This parameter determines the gateway or router used on your LAN for TCP/IP networking. Consult your network administrator about how to set this value.

Without a properly configured default gateway (whether you have a router/gateway or not), the FS1-X will be unable to see other FS1-Xs on the network, although you may still be able to control this FS1-X via a web browser. Also, without a proper gateway defined, the discovery feature on the *Network* web page will fail to list other FS1-Xs on the network.

Gateway Address variable	Enter the address of the gateway or router used to connect the FS1-X to the network. <i>Default</i> : 192.168.0.1
--------------------------	---

3 MAC Address (view only)

Selecting this parameter allows you to view the MAC address. The MAC address is a unique value associated with the FS1-X's internal network adapter. MAC addresses are also known as hardware addresses or physical addresses. MAC addresses uniquely identify an Ethernet adapter on a LAN.

MAC address format: MM:MM:MM:SS:SS:SS

The value is 12-digit hexadecimal, where the first half identifies the manufacturer and the second half identifies the unique serial number.

4 SNMP Menu Parameters

The following parameters are used to setup the FS1-X SNMP (Simple Network Management Protocol) feature.

- 4.0 SNMP Enable
- 4.1 SNMP Trap Destination 1
- 4.2 SNMP Trap Port 1
- 4.3 SNMP Trap Destination 2
- 4.4 SNMP Trap Port 2

In addition, the following parameters described below may affect SNMP messages:

- 5 Power Supply Alarm
- 6.1 Vid1 Format Alarm
- 6.2 Vid2 Format Alarm
- 7 Reference Alarm

Refer to "[Chapter 6: SNMP on page 109](#)" for a description of SNMP and how the FS1-X supports it.

5 Power Supply Alarm

This parameter controls how the FS1-X alarm responds to power supply disconnection or failure. If the FS1-X will be connected using only one power cord and supply, you can suppress the alarm. Changes to this setting are automatically saved.

Normal (default)	Alarm triggers if either internal power supply experiences a failure or is disconnected from mains power.
Suppress	Alarm will not be triggered by a power supply failure or disconnection from power.

6.1 Vid1 Format Alarm

When set to *Normal* (default), an alarm is triggered whenever the selected input video signal format of Video Proc 1 is incompatible with the selected output format (refer to the matrix of inputs and compatibilities presented in *Chapter 2*). If you want the FS1-X alarm to only trigger on hardware failures, you can suppress the *Format Alarm*. The front panel Vid 1 FMT ERR LED lights when format errors are detected even if this parameter is set to *Suppress*. Changes to this setting are automatically saved.

Normal (default)	Alarm triggers if the format of the selected input video signal is incompatible with the selected output format.
Suppress	Alarm will not be triggered by a format incompatibility.

6.2 Vid2 Format Alarm

This parameter operates the same as "[6.1 Vid1 Format Alarm](#)" above, but applies to the input video signal format of Video Proc 2.

7 Reference Alarm

This parameter controls how the FS1-X responds when one of the Video Processors has a format that is incompatible with the Reference video signal. When set to *NORMAL*, the alarm triggers if the Reference signal is not detected or is incompatible with the processor format. If you want the FS1-X Reference alarm to trigger only on hardware failures, you can suppress the alarm. Changes to this setting are automatically saved.

Normal (default)	Alarm triggers if the reference signal is not detected or is incompatible with the processor format.
Suppress	Alarm will not be triggered by reference errors.

NOTE: For proper operation the Input reference signal must be stable and properly terminated using a 75-ohm terminator on either the unused loop connector or the last piece of downstream equipment to which the Ref Video is connected.

8 Hidden Menus

This parameter lets you choose whether to hide or show inactive menus.

Hide Inactive (default)	Hides menus that are not in use.
Show All	Shows all menus, even those that are not in use.

9 Screen Saver

This parameter lets you choose the menu screen saver.

On (AJA Logo) (default)	AJA logo screen saver is displayed
System Name	Screen saver displays the system name.

10 Display Intensity

This parameter determines the brightness of the alphanumeric display and front panel LEDs.

Variable	Dim or brighten the alphanumeric display and activity indicator LEDs in steps from 1 (dim) to 8 (brightest). Default: 6
----------	---

11 Fan Speed

This parameter determines the speed (and sound level) of the FS1-X's internal cooling fans. To prevent system damage, this setting may be overridden temporarily, and the fan can be set to a higher speed if the system detects very high internal temperatures. Changes to this setting are automatically saved

Variable	Changes the fan speed in steps from 1 (slow) to 10 (fast). Default is 10.
----------	---

12 Serial Number

This parameter displays the FS1-X's unique serial number.

13 Software Version

This parameter displays the FS1-X's software version number.

14 Reboot

This parameter lets you reboot the FS1-X. Press and hold in both front panel knobs simultaneously to reboot.

During reboot, the display shows *[Rebooting]*, goes dark momentarily, and then shows the percentage of progress as the system reboots. Rebooting takes a couple of minutes.

PRESET Menu Group

The *PRESET* Menu Group provides the means of saving, editing the names of, and loading FS1-X presets. A preset is a set of all System, Video, Audio, and most Config parameters as they were set at the time the preset was stored.

	<p>Caution!</p> <p>When you recall a Preset Configuration, the recalled preset immediately replaces the system's existing configuration. All previous settings are lost unless you have previously stored them in another preset configuration or an exported file.</p>
---	--

During recall, the display reads, *Recalling* until the recall is finished. On recall completion, the displays shows the success or failure: *Recalled*, *Failed*, or *Empty*. A failed or empty recall does not recall anything and leaves the FS1-X as it was. (Preset registers are empty until you store something in them.)

During a store, the display reads *Storing* until the store is finished. On store completion, the display shows *Complete* or *Failed*. A failed store does not store anything and leaves the preset register as it was. To retry a failed store, turn *SELECT* to another preset number and then back to the desired preset number.

1 Factory Preset

This parameter recalls a read-only Factory Preset.

Factory Recall	Recalls factory values for all <i>System</i> , <i>Video</i> , <i>Audio</i> , and most <i>Config</i> parameters. Push <i>ADJUST</i> momentarily to perform (take) the recall. The display reports "Loading" and "Complete" during the recall. User preferences, network settings, and existing Presets are not affected by recalling the Factory Preset.
----------------	---

1.1-1.40 Presets #1-#40

These parameters let you recall, edit the name of, and store an FS1-X preset configuration for the selected storage register. Forty storage registers are available.

Preset #1-#40	Shows the currently selected preset register number. Turn <i>SELECT</i> choose the desired register. Then turn <i>ADJUST</i> to choose Recall, Edit Name, or Store for the selected register.
[Preset Name]	Shows the name of the selected preset register, which can be edited.
Recall	Recalls that preset. Push <i>ADJUST</i> momentarily to perform (take) the recall. The display reports "Loading" and "Complete" during the recall.
Edit Name	Enables editing the name of the preset register. Push <i>ADJUST</i> to enable editing (blinking character), use the <i>SELECT</i> and <i>ADJUST</i> knobs to edit the name and then press <i>ADJUST</i> to save the edited preset register name.
Store	Stores the current set of all <i>System</i> , <i>Video</i> , <i>Audio</i> , and most <i>Config</i> parameters to the selected preset register.

Video with Audio Routing

Presets can be used to coordinate audio and video routing. Store and name presets that match the desired audio inputs to each desired video input, and use those presets to select the video inputs, causing the configured audio to follow.

Interaction of Presets and GPIs

Triggering presets using GPI inputs offers considerable power but also requires some care to avoid unexpected results. If you plan to trigger presets using GPIs, please see the information about the *“Interaction of Presets and GPIs”* on page 54.

SYSTEM Menu Group

The *SYSTEM* Menu Group includes parameters for setting up various FS1-X system related features (video formats, audio level standards, etc).

1 Analog In Format

This parameter configures the format of the Analog (i.e. Component or Composite) video inputs, for SMPTE, Beta, or Composite. When SMPTE or Beta are selected, the three Component BNC inputs will be used. When Composite is selected, the single Composite BNC input will be used.

SMPTE YPbPr (default)	Configure the Component Video Input source as SMPTE YPbPr. This is the default for HD component video.
Beta YPbPr	Configure the Component Video Input source as Beta YPbPr (standard definition).
Composite	Choose the Composite Video input connector

2 Component Out Format

This parameter configures the format of the *Component* video output for SMPTE, Beta, or RGB.

SMPTE YPbPr (default)	Configure the Component Video Output as SMPTE YPbPr. This is the default for HD component video.
Beta YPbPr	Configure the Component Video Output as Beta YPbPr (SD).
RGB	Configure the Component Video Output as RGB.

3 Analog Audio Std

This parameter sets the *Analog Audio Input* and *Output* levels of the FS1-X with reference to full scale digital (0 dBFS). Selections range from consumer levels (+12 dBu) to SMPTE professional (+24 dBu).

+24 dBu (default)	Select +24 dBu as the expected analog audio level.
+18 dBu	Select +18 dBu as the expected analog audio level.
+15 dBu	Select +15 dBu as the expected analog audio level.
+12 dBu	Select +12 dBu as the expected analog audio level.
	(Above settings correspond to maximum amplitude–0 dBFS)

NOTE: See Chapter 3 FS1-X Audio Level Choices—Pro or Consumer regarding audio levels.

4 SDI1 3G Detect

This parameter configures 3G operation of the SDI 1 video input.

Auto Detect (default)	Automatically detects presence of 1080p50/60 or Dual Stream video.
1080p50/60	Configures the SDI1 input for 1080p50/60 (single) video.
Dual Stream	Configures SDI 1 for Dual Stream 3G video (uses SDI 1 and SDI 2 in Input Crosspoint matrix).

In *Auto Detect* mode, the hardware looks for SMPTE 352 Payload ID ANC data on the video inputs to determine whether there are two independent 1080i signals (Dual Stream) or a single 1080p50/60 signal. If there is no SMPTE 352 data, the default is to assume 1080p50/60 (single), but you can manually instruct the FS1-X to always assume either 1080p50/60 or *Dual Stream* by selecting one of those choices.

In 1080p50/60 mode, the system always assumes that the input is a single 1080p50/60 signal (even if there is SMPTE 352 data to the contrary).

NOTE: The 50/60 text in the menu and description above actually refers to 50/59.94 video. The FS1-X does not support 30 or 60 frame rate video.

In *Dual Stream* mode, the system always assumes (even if there is SMPTE 352 data to the contrary) that the input consists of two multiplexed independent 3G video streams. The signals are demuxed as shown.

Figure 12. Dual Stream 3G Mode Schematic

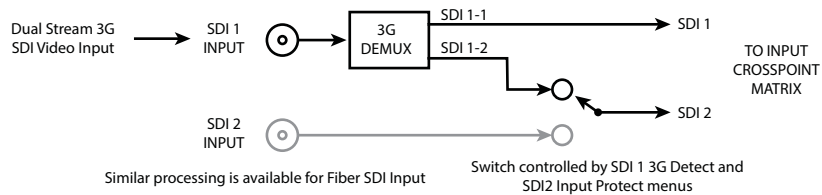

5 SDI2 Input Protect

This parameter allows you to protect Input SDI 2 from being taken by a *Dual Stream* selection made with *SDI1 3G Detect* above.

Normal (default) Dual Stream	SDI2 cannot be used by Dual Stream 3G SDI video on SDI Input 1. Allows SDI2 to be used by a Dual Stream 3G SDI input present on SDI 1.
---------------------------------	---

In the *Normal* setting (default), the SDI 2 video signal always comes from the SDI 2 physical input. Choosing *Auto Detect* or *Dual Stream* in *SDI1 3G Detect* does not switch away from the physical input.

In the *Dual Stream* setting, the FS1-X assumes both channels of Dual Stream 3G video are muxed onto a single wire at the SDI1 input. The SDI 2 video signal is then taken internally from the SDI 1 Stream 2 signal instead of the SDI2 In connector.

The following table shows the selections and their results. In the table, SDI1-1 and SDI1-2 are the two muxed streams entering the SDI1 Input.

SDI-3G Detect Setting	SDI2 Input Protect Setting	1 Video Input Setting	Resulting Input to Crosspoint Matrix
(Dual Video signal) <i>Dual Stream</i> setting, or <i>Auto Detect</i> with ANC Dual Stream data	Dual Stream	SDI1	SDI1-1
		SDI2 (unused)	SDI1-2
	Normal	SDI1	SDI1-1
		SDI2	SDI2

SDI-3G Detect Setting	SDI2 Input Protect Setting	1 Video Input Setting	Resulting Input to Crosspoint Matrix
(Single Video signal) 1080p 50/60 setting, or Auto Detect with ANC 1080p data, or Auto Detect with no ANC data	Dual Stream	SDI1	SDI1
		SDI2	SDI2
	Normal	SDI1	SDI1
		SDI2	SDI2

6 Fiber1 3G Detect

This parameter configures 3G operation of the Fiber 1 video input, using settings similar to [“4 SDI1 3G Detect” on page 59](#).

7 Fiber2 Input Protect

This parameter allows you to protect Input Fiber 2 from being taken by a *Dual Stream* selection, using settings similar to [“5 SDI2 Input Protect” on page 60](#).

8 Genlock Source

This parameter selects the source of reference video used for genlock, either automatically or explicitly. The same setting is applied to Video Processor 1 and Video Processor 2

Reference (default)	Use the signal on the <i>Ref</i> connector as the genlock source.
Vid 1 Input	Use the <i>Vid1</i> input signal as the genlock source.
Free run	Free run mode (FS1-X syncs to its own timebase, not locked to an external source).

NOTE: *HDMI can be used as a reference, but HDMI is not a valid reference source when the signal on the HDMI input originates from a VESA-format computer DVI signal.*

9 Output Frame Rates

This parameter selects the HD video frame rate associated with the video standard.

59.94/23.98 (default)	Select 59.94/23.98 if your desired rate is either 59.94 or 23.98.
50/25	Select 50/25 if your desired rate is either 50 or 25 (PAL).
24	Select 24 if your desired rate is 24.

NOTE: *Changing the Frame Rates selection automatically selects a new value for “2 Output Format” on page 65. Each Frame Rates selection remembers its own Output Format settings.*

10 FRC Enable

NOTE: *The Frame Rate Converter option for FS1-X is no longer available from AJA.*

This parameter Enables or Disables the factory installed Frame Rate Converter (FRC) option, if present. When present, the FRC PRES LED on the FS1-X front panel will be ON.

Enable (default)	Enables the FRC The FS1-X will operate in one channel mode, using only Video Processor 1, and will activate the FRC when required.
Disable	Disables the FRC. The FS1-X operates in two channel mode (using both Video Processors 1 and 2), using add/drops for frame rate conversion.

In the *Enable* setting, when supported FRC format conversion is being performed the FRC ACTIVE LED on the FS1-X front panel will be ON, and its status will be reported as Active on the front panel display and web pages. If the FRC is not actively being used for conversion, the FRC ACTIVE LED will be off, and its status will be reported as Bypass on the front panel and web pages. The *Enable* setting also disables Video Processor 2, which will report a No Output status, although a black video signal is generated if Video Processor 2 is routed to an output. Any embedded audio routed to a Video Processor 2 output will also be passed along with that black video signal.

In the *Disable* setting, advanced Frame Rate Conversion is disabled (add/drop frames will be used instead), and both Video Processor 1 and Video Processor 2 become available for use.

NOTE: *This parameter menu is not available if the FRC option is not installed.*

NOTE: *The FRC must be disabled or not installed to do Reverse Telecine. See “FS1-X Reverse Telecine Conditions” on page 81.*

11 NTSC Standard

This parameter selects the NTSC video standard. This setting only applies when parameter “9 Output Frame Rates” is “59.97/23.98”.

NTSC (default)	Select NTSC for North America.
NTSC Japan	Select NTSC for Japan.
PAL M	Select PAL-M for Brazil.

The NTSC standard applies to both the Output video standard, and the expected Input video standard. The FS1-X does not convert NTSC to PAL-M, or vice-versa.

12 Composite Downconv

This parameter selects the type of down conversion performed on the incoming selected HD source input for the analog composite (NTSC or PAL) video output.

Crop (default)	Image is cropped to fit new screen size.
Anamorphic	HD image is converted to full-screen SD with a 16x9 aspect ratio (anamorphic).
14x9	Image is reduced slightly with aspect ratio preserved. Black is added top and bottom, and the left and right sides are cropped.
Auto AFD	Automatically selects the best Downconvert mode based on the input video's Active Format Description (AFD) code. If the input video is not carrying an AFD VANC code, the Downconverter defaults to the mode specified in parameter menu “8 Downconvert Mode”.
Letterbox	Image is reduced with black top and bottom added to image area, with the aspect ratio preserved.

NOTE: *Using the Downconverter adds a frame of video delay, making the analog Composite output be one frame behind the other outputs.*

13 HDMI RGB Range

This parameter selects the output range for HDMI YCbCr. *Full* allows a range of 0-255 and *SMPTE* limits the range to 16 to 235 (see note for details).

NOTE: *YCbCr luminance (Y) channel data ranges nominally between 16 (black) and 235 (white). Values outside of this range are typically clamped to the valid range. This may cause confusion because JPEG JFIF YCbCr values range between 0 and 255. Mixing these values*

causes video contrast shifts. You can avoid these shifts if you maintain one range of values throughout your system.

Full (default)	Selects an HDMI luminance output range of 0-255.
SMPTE	Selects an HDMI luminance output range of 16-235.

14.0 AES/EBU SRC Mode

This parameter controls the mode of the audio sample rate converters for AES/EBU input audio pairs.

Auto (default)	The system decides how to handle sample rate conversion. AES signal pass normally through the Sample Rate Converters, unless a non-audio flag is set in the Channel Status Word.
Manual	The FS1-X determines what to do about audio sample rate conversion on a channel pair-by-pair basis, determined by the following Channel Pair menu settings.

In *Auto* mode, normal PCM audio passes through the Sample Rate Converters and gets converted, as appropriate. AES channels in which the *non-audio* flag is set in the Channel Status Word are automatically detected and allowed to bypass the Sample Rate Converters; the signal passes unaltered and the existing data is preserved.

In *Manual* mode, the sample rate converters are turned ON or bypassed manually for each AES pair using the following Channel Pair menus. If a channel pair is set to *Bypass*, the FS1-X leaves embedded audio as is, bypassing sample rate conversion. This is useful for Dolby® 5.1 embedded audio and other applications where you do not want sample rate conversion to occur.

14.1–14.8 AES/EBU SRC

This group of parameters controls audio sample rate conversion on AES/EBU input audio channel pairs 1/2, 3/4, 5/6, 7/8, 9/10, 11/12, 13/14, and 15/16. When AES/EBU SRC Mode is set to *Manual*, these menus become available, allowing each channel pair to be set manually to *On* or *Bypass*.

On (default)	Audio sample rate conversion (SRC) is applied to the affected channel pairs and keeps the video and audio synchronized.
Bypass	Audio sample rate conversion (SRC) is NOT applied to the affected channel pairs. The signal is passed through unaltered.

On is the default setting in which audio is rate-converted and synced with video (SRC is applied).

Bypass is available for use when Dolby® 5.1 and similar schemes need to be preserved and the audio data passed unaltered (no SRC is applied).

Set these parameters to *Manual* and *Bypass* only if BOTH the following items are true:

- You want to pass unaltered digital encoded audio from either an embedded or AES Input to an embedded and/or AES Output.
- You have the embedded or AES input genlocked to the FS1-X output. In other words, the encoded audio will not survive the frame-sync function (dropping or repeating frames) so it needs to be set to lock to the input. You can lock to a reference only if that reference is driving both the FS1-X and the upstream source of the embedded or AES input to the FS1-X.

15.1 MADi BNC Out

This parameter controls the number of MADi channels sent to the MADi BNC output connector. When the FS1-X receives 56 channels and outputs 64 channels, active silent channels 57 to 64 are added. When the FS1-X receives 64 channels and outputs 56 channels, channels 57 to 64 are dropped.

64ch (default)	Sixty four audio channels selected for MADi BNC output.
56ch	Fifty six audio channels selected for MADi BNC output.

15.1 MADi Fiber Out

This parameter controls the number of MADi channels sent to the MADi Fiber output connector. When the FS1-X receives 56 channels and outputs 64 channels, active silent channels 57 to 64 are added. When the FS1-X receives 64 channels and outputs 56 channels, channels 57 to 64 are dropped.

64ch (default)	Sixty four audio channels selected for MADi Fiber output.
56ch	Fifty six audio channels selected for MADi Fiber output.

VIDEO PROC Menu Group

The following descriptions explain the Video Proc Menu Groups. The Video Proc menu displays are formatted as follows

Display	Description
MENU # TITLE PARAMETER VALUE	Menu number and title. Currently selected parameter value for this menu.
INPUT FORMAT	Video Processor 1 Input Output Format

The currently selected Input video source and output video format for Video Processor 1 is reported on the bottom line of each menu.

Video Input and Output

These parameters perform input video source selection for the selected Video Processor (1 or 2). Multiple input sources are available at the connectors on the FS1-X rear panel, but the active input source routed to the selected Video Processor is the one you select here.

1.1 Video 1 Input

SDI1 (default)	Select SDI1 as the input source.
SDI2	Select SDI2 as the input source.
SDI DualLink	Select SDI DualLink, linking both SDI inputs as the input source.
Fiber1	Select Fiber1 as the input source.
Fiber2	Select Fiber2 as the input source.
Fiber DualLink	Select Fiber DualLink, linking both Fiber inputs as the input sources.
HDMI	Select the HDMI input as the input source.
Analog	Select Analog as the input source. Component or Composite analog video is set with "1 Analog In Format" on page 59 .

Source Memory Changing the Video Input selection automatically selects new values for Proc Amp parameters and Color Corrector (RGB) parameters. Each video source remembers its own Proc Amp and Color Corrector settings. This is referred to as Source Memory.

Dual Link Dual Link referred to here is 1080p50/59.94 on two 1.5 Gb HD-SDI connections. Selecting Dual Link as the Video Input for Video Processor 1 or 2 will allocate both SDI Inputs for Dual Link use. Both Processors can use the Dual Link Input, or if only one Processor is using it, the other Processor is free to select another input. The Fiber inputs operate the same way.

1.2 Video 2 Input Same settings as above, but affects Video Processor 2.

2 Output Format This parameter defines the output format of the Video Processor 1. Available choices depend on the frame rate selection.

Follow INPUT (default)	Follow the format of the selected Video Processor 1 input. <i>Note: The Video Processor 2 output format always follows the Video Processor 2 input format.</i>
Follow REF	Follow the format of the reference input (Ref).
525i/625i<frame rate>	Select 525i/625i SD as the output.
720p<frame rate>	Select 720p HD as the output.
1080i<frame rate>	Select 1080i HD as the output.
1080PsF<frame rate>	Select 1080PsF HD as the output.
1080p<frame rate>	Select 1080p HD as the output.
2K1080p<frame rate>	Select 2K1080p HD as the output.

Output Format Selection Constraint Available frame rates depend on System menu *“9 Output Frame Rates” on page 61* parameter setting.

Output Timing Memory Changing the Output Format selection automatically selects new values for H & V timing parameters (see *“Timing and Delay” on page 66*). Each Output Format mode remembers its own H and V timing settings.

Output Format Mapping The Output Format selection is remembered for each of the frame rates. If you change the Output Frame Rate (*“9 Output Frame Rates” on page 61*), the Output Format setting associated with the newly selected frame rate is recalled.

3 Video 1 Output Mode The parameter sets the final video output of Video Processor 1 to normal video or the test pattern generator. Alarms occur if conflicting video formats are selected.

Normal (default)	Normal video is output from the processor.
Test Pattern	The output of the test pattern generator.

NOTE: Normal output for the Video Processor 1 can be a version of its currently selected input, a Sidebar or Letterbox display, a Freeze of last good video, or Black, depending on how the Video 1 process or has been configured.

Loss of Input

This parameter selects the automatic action that occurs if the video input is lost. The *Black* selection (default) cuts the video to black. The *Freeze* selection freezes video on the last available good frame.

4.1 Video 1 Loss of Input

Black (default)	Switches to black if input video is lost.
Freeze	Freezes on the last available good video frame if input is lost.

4.2 Video 2 Loss of Input Same settings as above, but affects Video Processor 2.

Timing and Delay

These parameters adjust Video Processor horizontal and vertical output timing in reference to the genlock source already selected, and permits adding up to 6 full frames of output delay.

NOTE: Unlike most knob-adjustable parameters, on the front panel menu this parameter automatically wraps around from the maximum value to 0 (and vice versa).

Output Timing Memory Independent horizontal and vertical timing values are kept for all available output formats.

Output Timing Ranges The table below lists the output timing ranges for various video frame rates.

Table 6. Output Timing Ranges

Output Frame Rate	Horizontal		Vertical	
	Min	Max	Min	Max
1080i50	0	2639	-562	562
1080i59.94, 1080i60	0	2199	-562	562
1080p23.98, 1080p24	0	2749	-562	562
1080p25	0	2639	-562	562
1080p29.97, 1080p30	0	2199	-562	562
1080p50	0	2639	-562	562
1080p59.94, 1080p60	0	2199	-562	562
1080psf23.98, 1080psf24	0	2749	-562	562
1080psf25	0	2639	-562	562
1080psf29.97, 1080psf30	0	2199	-562	562
2Kx1080p23.98, 2Kx1080p24	0	2749	-562	562
2Kx1080p25	0	2639	-562	562
2Kx1080p29.97, 2Kx1080p30	0	2199	-562	562
2Kx1080p50	0	2639	-562	562
2Kx1080p59.94, 2Kx1080p60	0	2199	-562	562
525i59.94, 525psf29.97	0	857	-262	262
625i50, 625psf25	0	863	-312	312
720p23.98, 720p24	0	4124	-375	375
720p25	0	3959	-375	375
720p29.97, 720p30	0	3299	-375	375
720p50	0	1979	-375	375
720p59.94, 720p60	0	1649	-375	375

NOTE: The table above is intended for reference only. It includes 30 and 60 frame rates that are not supported by the FS1-X.

5.1 Video 1 Output Timing H When adjusting the horizontal timing (H), this parameter specifies a number of pixels to offset, from zero to full line width. Adjustment range increments from 0 to the width of the line in pixels. The maximum value varies, depending on the format already chosen.

Variable	Adjustment range increments from 0 to the width of the line in pixels. The maximum varies, depending on the format chosen. <i>Default: 0</i>
----------	---

5.2 Video 1 Output Timing V When adjusting the vertical timing (V), this parameter specifies a number of lines to offset, moving the screen up to a half a frame up or down.

Variable	Adjustment range increments from half a frame up to a half a frame down in single line increments. The maximum varies, depending on the format already chosen. <i>Default: 0</i>
----------	---

5.3 Video 1 Frame Delay This parameter adjusts Video Processor output timing.

Variable	Adjustment output timing from 0 to 6 frames down in one frame increments. <i>Default: 0</i>
----------	--

NOTE: This delay amount is in addition to the default video delay, which is nominally two frames at low frame rates (25/30 fps) or four frames at high frame rates (50/60 fps).

5.4 Video 2 Output Timing H Same settings as above, but affects Video Processor 2.

5.5 Video 2 Output Timing V Same settings as above, but affects Video Processor 2.

5.6 Video 2 Frame Delay Same settings as above, but affects Video Processor 2.

Background Fill

This parameter selects the background source used to fill any part of the processor output raster not filled with video from the main input video. For example, when the Video Output Mode selection is Sidebars, this parameter selects the video source for the Sidebars.

6 Background Fill

Black (default)	Selects black as the background fill video.
Video 2	Selects the output of Video Processor 2 as the background fill video. Only available when operating in 2 Channel mode.
Matte	Selects matte as the background fill video.

Upconvert and Downconvert

These parameters select the type of upconversion the Video Processor performs on the selected SD source input, or the type of downconversion performed on the selected HD source input.

NOTE: Any Custom Size/Pos values will be applied on top of these Upconvert and Downconvert settings (except when Downconvert Mode is set to AUTO AFD).

NOTE: When converting to or from 2K, the selections do not precisely describe the resulting picture. For example, 4x3 pillar is not precisely 4x3, and 14x9 is not precisely 14x9. However, picture scaling is such that the visual effect closely resembles an SD-to-HD upconvert.

7 Upconvert Mode This parameter selects the type of upconversion performed by the Video Processor. This parameter is in effect only when the input is SD (525i or 625i) and the selected output format is HD (720p, 1080i, or 1080p), or when the input is HD (720p, 1080i, or 1080p) and the output is 2K (2048 x 1080). See the following Upconvert Illustrations for examples.

4x3 Pillar (<i>default</i>) 14x9 Pillar	Results in 4x3 image at center screen with black sidebars. Results in 14x9 image, zoomed slightly to fill a 14x9 image with black sidebars.
Full Screen LB to Full Wide Zoom	Anamorphic full screen display. Image is zoomed to fit the full screen (letterbox). Using a combination of zoom and stretch, the image is sized to fit a 16x9 screen (this can introduce a small aspect ratio change).

Upconvert Illustrations

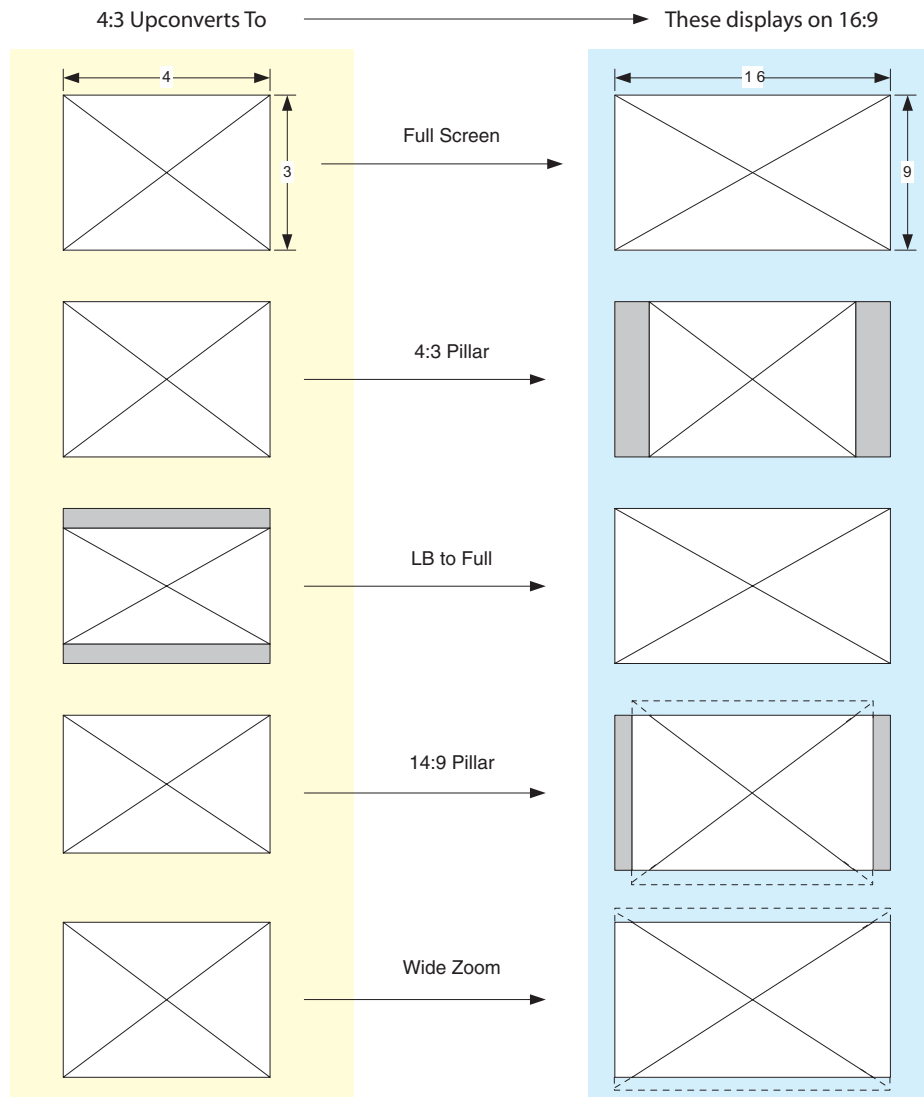

8 Downconvert Mode This parameter selects the type of downconversion performed by the Video Processor. This parameter is in effect only when the input is HD (720p, 1080i, or 1080p) and the output format is SD (525i or 625i), or when the input is 2K (2048 x 1080) and the output is HD (720p, 1080i, or 1080p). See the following Downconvert Illustrations for examples.

Crop (<i>default</i>)	Image is cropped to fit new screen size.
Anamorphic	HD image is converted to full-screen SD with a 16x9 aspect ratio (anamorphic).
14:9	Image is reduced slightly with aspect ratio preserved. Black is added top and bottom, and the left and right sides are cropped.
Auto AFD	Automatically selects the best Downconvert mode based on the input video's Active Format Description (AFD) code. If the input video is not carrying an AFD VANC code, the Downconverter defaults to the mode specified in parameter menu "17.3 Downcvt AFD Dflt" on page 78.
Letterbox	Image is reduced with black top and bottom added to image area, with the aspect ratio preserved.

Active Format Description (AFD) codes are carried in the vertical ancillary (VANC) portion of HD SDI video signals, specified in SMPTE 2016 as follows: "AFD information is intended to guide DTV receivers and/or intermediate professional video equipment regarding the display of video of one aspect ratio on a display of another aspect ratio."

In the FS1-X Downconverter, the AFD code on the video input can be used to guide the Downconverter in choosing which mode to use to best display the important content of the input 16:9 HD video on the 4:3 SD output. For example, if the input AFD code is 10 (Full Frame), it means that the input video has important picture information throughout the full 16:9 frame, so the Downconverter should use Letterbox mode to be sure none of the content is cropped off. An AFD code of 9 (Pillarbox) says that the input video only has content within the center 4:3 area of the picture (usually because it originally came from an Upconverted SD signal) so the Downconverter Crop mode would be the best choice. There are 16 possible HD AFD codes, of which eight are in common use. The FS1-X does not process or use SD AFD codes.

FS1-X AFD processing (passing, removing, and re-inserting) occurs based on the setting of parameters ["8 Downconvert Mode"](#) on page 69, ["12 Composite Downconv"](#) on page 62, and ["AFD"](#) on page 76.

Auto AFD mode fully defines the size, position, and aspect ratio of the output raster. Thus, when in *Auto AFD* mode (Output Format set to an SD format, with an HD video input, and *Downconvert Mode* set to *Auto AFD*), any *Custom Size/Pos* settings are ignored, and those menus are hidden. Likewise, when in *Auto AFD* mode, any *Region Of Interest* settings are ignored, and those menus are hidden.

Downconvert Illustrations

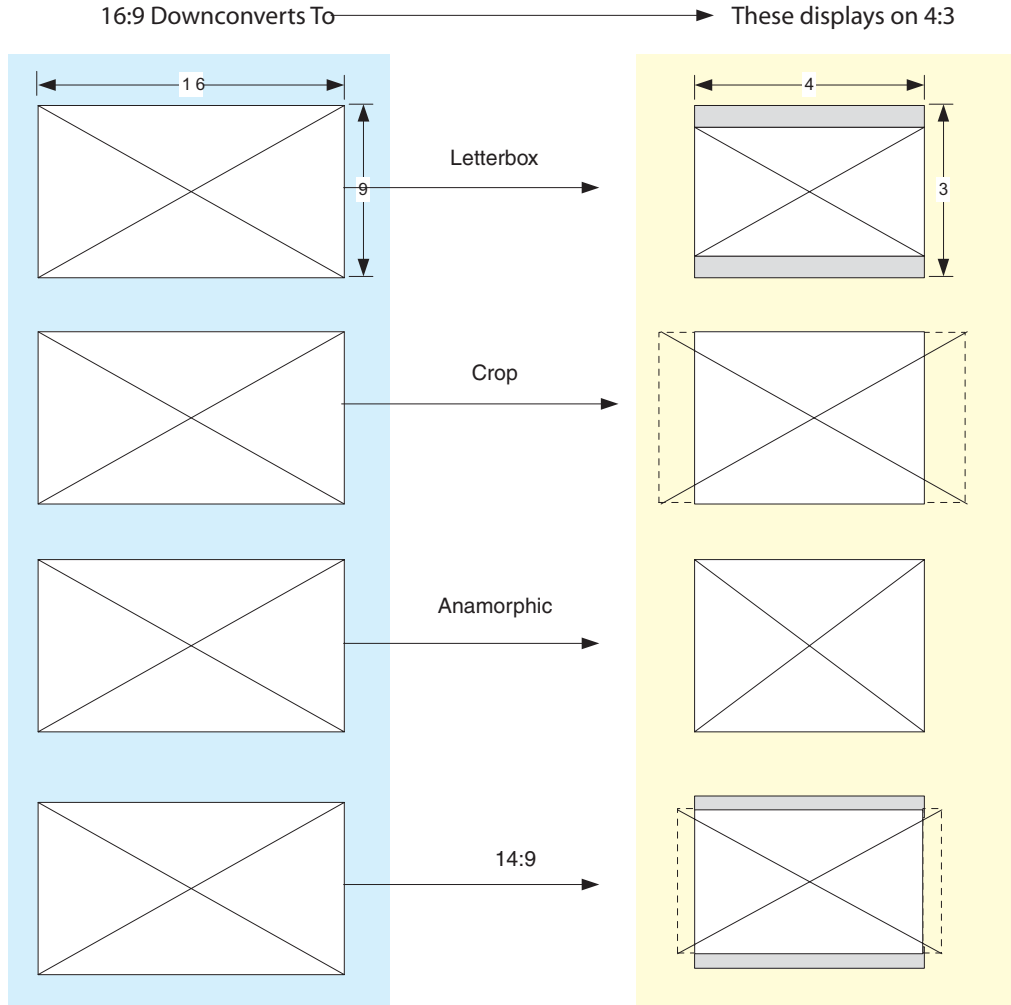

SD Aspect Ratio

This parameter selects the type of SD-to-SD Aspect Ratio Conversion (ARC) performed on an incoming selected SD source. This parameter is in effect only when the input and output are both SD (525i or 625i). (In Europe 16:9 anamorphic video is also known as “wide screen” video.)

9 SD Aspect Ratio Convert

Off (<i>default</i>)	Turns aspect ratio conversion <i>Off</i> .
Letterbox	Converts 16:9 Anamorphic video to Letterbox video.
H Crop	Converts 16:9 Anamorphic video to 4:3 Standard video (crops left and right edges of video).
Pillarbox	Converts 4:3 Standard video to 16:9 Anamorphic video.
V Crop	Converts Letterbox video to 16:9 Anamorphic video.
14:9	Converts 16:9 Anamorphic video to 14:9 Cropped video.

SD Aspect Ratio Conversion Illustrations

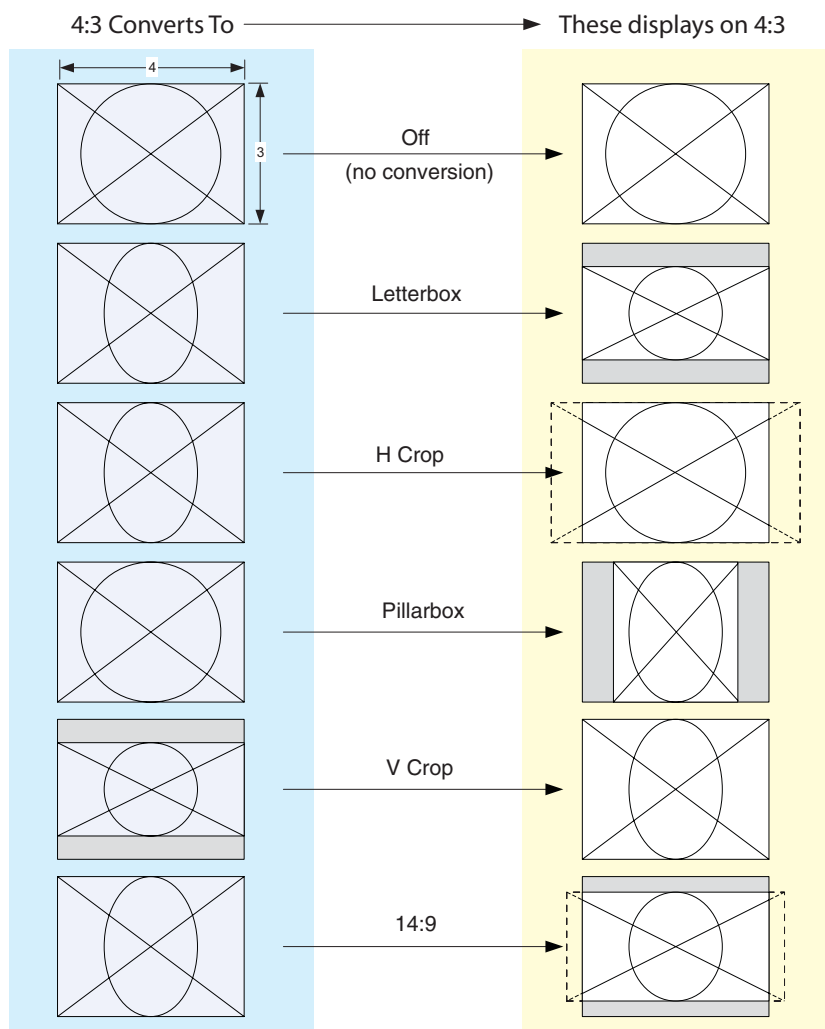

Sidebars

The parameter adjusts the sidebar position where the center video meets the pillarbox background video on both sides. The underlying hardware feature is the same as *Custom Right Crop* and *Custom Left Crop*. This is effectively an extra handle on the *Left Crop* and *Right Crop* parameters.

The *Crop* and *Sidebar Edge* controls are additive; increasing *Sidebar Edge* (making the sidebars larger and the center-video smaller), equates to setting *Left Crop* and *Right Crop* values to smaller percentages. The *Sidebar Edge* can be set to 0 through +128. A value of 0 produces a 4:3 center. Positive values produce wider sidebars (and a narrower center).

10 Sidebar Edge

<p>0 (default) 0 to +128 (Variable)</p>	<p>Defaults to 0. Select a width value from 0 through +128 to expand or shrink the sidebars, which are filled with Background video (4 Background Fill). Selecting a larger value causes the center picture to become narrower while the sidebars expand.</p>
---	---

Matte of Background Fill

11.1 Matte Luma This parameter determines the Matte Luma level of the background fill.

50% (<i>default</i>) 0–100% (Variable)	Sets the matte luminance level to the default 50% value. Sets the matte luminance level from 0–100%.
---	---

11.2 Matte Chroma This parameter determines the Matte Chroma level of the background fill.

50% (<i>default</i>) 0–100% (Variable)	Sets the matte chrominance level to the default 50% value. Sets the matte chrominance level from 0–100%.
---	---

11.3 Matte Hue This parameter determines the Matte Hue of the background fill.

0 degrees (<i>default</i>) 0–359 degrees (Variable)	Sets the matte hue to the default 0 degrees (red). Sets the matte hue to a value between 0 and 359 degrees.
--	--

NOTE: On the front panel, as you turn the Matte Hue ADJUST knob the values wrap from 359 back to 0 degrees.

Proc Amp Controls (YUV)

12.0 Proc Amp (YUV) This parameter turns the Proc Amp *On* and *Off* for signals composed of YUV components. When it is *On*, you can set additional parameters to control video *Gain*, *Black Level*, *Hue*, and *Saturation*.

Off (<i>default</i>) On	Sets the YUV Proc Amp to Off. Sets the YUV Proc Amp to On.
------------------------------	---

Source Memory Independent Proc Amp parameter values are kept for each input format.

12.1 Proc Amp Gain This parameter adjusts the video gain from 0 to 1.5 times luma in 0.01 steps

Variable	Adjusts Proc Amp Gain from zero to 1.5 in 0.01 steps. <i>Default (unity):</i> 1.0
----------	--

12.2 Proc Amp Black This parameter adjusts the video black level from -20 IRE to +20 IRE in 0.5 steps.

Variable	Adjusts Proc Amp Black level from -20 IRE to +20 IRE in 0.5 steps. <i>Default (unity):</i> 0 IRE
----------	---

12.3 Proc Amp Hue This parameter adjusts the video color hue through 360 degrees (color wheel) in 1 degree steps.

Variable	Adjusts Proc Amp Hue from -179 to +180 in steps of 1 degree. <i>Default (unity):</i> 0 degrees
----------	---

12.4 Proc Amp Sat This parameter adjusts the video color saturation from black and white to 1.5 times chroma in steps of 0.01.

Variable	Adjusts Proc Amp Saturation from 0 (black & white) to 1.5 (Chroma) in steps of 0.01. <i>Default: 1.0</i>
----------	---

Color Corrector (RGB)

13.0 Color Corrector (RGB) This parameter turns the RGB Color Corrector *On* and *Off*. When it is *On*, you can set additional parameters to control RGB video *Gain*, *Black Level*, and *Gamma*. When set to *Off*, all RGB Color Corrector settings are programmed for unity (or bypass).

Off (<i>default</i>)	Sets the RGB Color Corrector to Off.
On	Sets the RGB Color Corrector to On, enabling the following Color Corrector parameters.

Source Memory Independent RGB Color Correct parameter values are kept for each input format.

13.1 Color Red Gain This parameter adjusts the *RGB Red Gain*.

Variable	Adjusts Red Gain from zero to 1.5 in 0.01 steps. <i>Default (unity): 1.0</i>
----------	---

13.2 Color Red Black Level This parameter adjusts the *RGB Red Black* level.

Variable	Adjusts Red Black level from -20 IRE to +20 IRE in 0.5 steps. <i>Default (unity): 0 IRE</i>
----------	--

13.3 Color Red Gamma This parameter adjusts the *RGB Red Gamma*.

Variable	Adjusts Red Gamma level from -1.0 to +1.0 in 0.01 steps. <i>Default (unity): 0</i>
----------	---

13.4 -13.6 Color Green This set of parameters adjusts the Gain, Black Level, and Gamma for color Green, same as Color Red described above.

13.7-13.9 Color Blue This set of parameters adjusts the Gain, Black Level, and Gamma for color Red Blue, same as Color Red described above.

Custom Conversion Settings

The custom settings determine the image size and shape for Upconvert and Downconvert modes if you choose the *Custom* selection for those modes.

Custom settings are stored separately for each Conversion Mode. Values for each of the Upconvert modes, Downconvert modes (excluding AFD), and SD Aspect Ratio modes (excluding OFF), plus no conversion (or HD CrossConvert), are independently stored.

NOTE: If Custom Size/Pos is On and any of the following parameter are not set to unity, the front panel UFC LED lights.

14.0 Custom Size/Pos This parameter turns custom image settings *On* or *Off*.

When Hide Inactive is on, the *Custom Size/Position* controls are only displayed when *Custom Size/Pos* is On. When *Custom Size/Pos* is Off, modified parameters are skipped in the menu system, and the UFC hardware is programmed for unity.

This menu is also not displayed when Active Format Description (AFD) is in control of the Conversion Mode. While downconverting, with Downconvert Mode set to Auto AFD, any values assigned for Custom Size/Pos parameters are ignored, and the menus are hidden.

Off (default) On	Sets this parameter and related custom size/pos parameters to off. Enables this parameter and related custom size/position parameters.
---------------------	---

14.1 Custom Size This parameter changes the H and V size of the output picture by the specified percentage (%) while maintaining the current aspect ratio.

100% (default) 10% to 200%	Maintains 100% picture size for the selected format. Enables changing the picture size.
-------------------------------	--

14.2 Custom Aspect This parameter changes the H/V aspect ratio of the output picture while maintaining the current V size (Aspect < 0) or H size (Aspect > 0).

0.000 (default) -0.500 to +0.500	Maintains the normal 100% aspect ratio for the selected format. Enables changing the aspect ratio.
-------------------------------------	---

14.3 Custom H Position This parameter changes the H position of the output picture.

0% (default) -100% to +100%	Maintains the normal horizontal position of the selected format. Enables changing the horizontal position.
--------------------------------	---

14.4 Custom V Position This parameter changes the V position of the output picture.

0% (default) -100% to +100%	Maintains the normal 100% vertical position of the selected format. Enables changing the vertical position.
--------------------------------	--

14.5 Custom Left Crop This parameter changes the Left picture crop position.

100% (default) +10.0% to +100.0%	Maintains the normal left side position of the selected format. Enables changing the left side position.
-------------------------------------	---

14.6 Custom Right Crop This parameter changes the Right picture crop position.

100% (default) +10.0% to +100.0%	Maintains the normal right side position of the selected format. Enables changing the right side position.
-------------------------------------	---

14.7 Custom Top Crop This parameter changes the Top picture crop position.

100% (default) +10.0% to +100.0%	Maintains the normal top position of the selected format. Enables changing the top position.
-------------------------------------	---

14.8 Custom Bottom Crop This parameter changes the bottom picture crop position.

100% (default) +10.0% to +100.0%	Maintains the normal bottom position of the selected format. Enables changing the bottom position.
-------------------------------------	---

Region of Interest (ROI)

The *Region of Interest* parameters select a portion of the input picture that will be used for scaling and/or positioning. The selected area can then be scaled to a standard pillarbox or letterbox size and shape (*On Square*), or it can be set to a full screen input image (*On Full*).

NOTE: *On Full* may cause image distortion if it is used to expand an odd-shaped region of interest to full screen.

The *ROI Setup* mode allows you to preview the edges of your selected *Region Of Interest* as you set it up. After selecting the desired region using the Setup Cursor, you can take the region to air by setting *Region Of Interest* to *On Square* or *On Full*.

The *Setup* mode is not required to operate the ROI feature. The edges of the Region Of Interest can also be adjusted while in *On Square* or *On Full* modes

15.0 Region of Interest This parameter turns the Region of Interest settings *On* or *Off*. When enabled, the *ROI Left*, *Right*, *Top*, and *Bottom* controls define the rectangular shape and position of the ROI.

Off (default)	Turns off the ROI feature.
Setup	Enables ROI cursor.
On Square	Enables ROI and sets video to a pillarbox or letterbox shape.
On Full	Enables ROI, and expands the ROI area to full screen.

Interactions occur between ROI settings and other parameters:

- The *Region of Interest* menu is not displayed when *Active Format Description (AFD)* is in control of the Conversion Mode. While downconverting, with *Downconvert Mode* set to *Auto AFD*, any values assigned for *ROI* parameters are ignored.
- *Custom Size and Position* settings work interactively with ROI, but *Custom Crop* settings are disabled. *Custom Size/Pos* is also temporarily disabled while in the *ROI Setup* mode.

15.1 ROI Left This parameter sets the left boundary of the ROI.

Variable (default=100%)	Sets ROI left boundary to 10-100% of full screen in 0.1% increments. For 1% increments, hold down the Video button.
-------------------------	---

15.2 ROI Right This parameter sets the right boundary of the ROI.

Variable (default=100%)	Sets ROI right boundary to 10-100% of full screen in 0.1% increments. For 1% increments, hold down the Video button.
-------------------------	--

15.3 ROI Top This parameter sets the top boundary of the ROI.

Variable (default=100%)	Sets ROI top boundary to 10-100% of full screen in 0.1% increments. For 1% increments, hold down the Video button.
-------------------------	--

15.4 ROI Bottom This parameter sets the bottom boundary of the ROI.

Variable (default=100%)	Sets ROI bottom boundary to 10-100% of full screen in 0.1% increments. For 1% increments, hold down the Video button.
-------------------------	---

Video Legalizer

These parameters allow adjustment of signal levels to meet legal broadcast requirements.

16.0 Video Legalizer This parameter determines the Video Legalizer mode. When set to *Off*, the Video Legalizer is not enabled, and the following clip controls are not active. In *YUV* mode, the *White Clip*, *Black Clip*, and *Chroma Clip* controls are enabled and clip any luma/chroma that exceed the set limits. In *RGB* mode only the *White Clip* and *Black Clip* controls are active and limit the R, G, and B values to those settings. RGB mode requires the video to pass through the RGB Proc Amp to be converted to and from RGB.

Off (default)	Disables the Video Legalizer.
YUV	Enables the Video Legalizer to clip YUV to legal levels.
RGB	Enables the Video Legalizer to clip RGB to legal levels.

16.1 Legalizer White Clip When the Video Legalizer mode is *YUV* or *RGB*, this parameter limits the white level so that it does not exceed the adjusted limit. Limit can be set from +80 IRE to +120 IRE.

Variable	Adjusts white clip level from +80 IRE to +120 IRE in 0.5 steps. <i>Default (unity): 100 IRE</i>
----------	--

16.2 Legalizer Black Clip When the Video Legalizer mode is *YUV* or *RGB*, this parameter limits the black level to the adjusted limit. Limit can be set from -10 IRE to +20 IRE,.

Variable	Adjusts black level limit from -10 IRE to +20 IRE in 0.5 steps.
Default (unity): 0 IRE	

16.3 Legalizer Chroma Clip When the Video Legalizer mode is *YUV*, this parameter limits the maximum chroma level to the adjusted limit. The limit can be set from +60% to +140%,.

Variable	Adjusts chroma clip level from +60% to +140% in 0.5 steps.
Default (unity): 100 IRE	

AFD

These parameters determines if and where the Video Processor will insert a SMPTE 2016 Active Format Descriptor (AFD) packet into its output video. The inserted AFD code does not affect the Video Processor's up/down/cross conversion, but it may affect downstream video processing if the signal is Downconverted.

NOTE: AFD codes are only inserted into HD video outputs.

17.1 AFD Out These determines whether the Video Processor inserts an AFD packet into the output video.

OFF (default)	The FS1-X does not insert an AFD code into the output. If the video input has a AFD code and the FS1-X is not up/down/cross-converting it, the input AFD code will be passed through to the output.
Auto	If the FS1-X is not Upconverting or Downconverting the input video, the input AFD code is passed through. If there is no AFD code on the input video, a "Full Frame" (8) code is inserted. If the FS1-X is Upconverting, the appropriate AFD code will be chosen based on the Upconvert mode.
>16:9	The FS1-X always inserts a "Box > 16:9 (center)" AFD code (4), which indicates that the HD image has an aspect ratio greater than 16:9 as a vertically centered letterbox within the 16:9 frame.
Full Frame	The FS1-X always inserts a "Full Frame" AFD code (8), which indicates that the HD image is full frame, with an aspect ratio that is 16:9.
Pillarbox	The FS1-X always inserts a "4:3 (center)" AFD code (9), which indicates that the HD image has a 4:3 aspect ratio as a horizontally center pillarbox image within the 16:9 frame.
Letterbox	The FS1-X always inserts a "16:9 (with complete 16:9 image protected)" AFD code (10), which indicates that the HD image is full frame, with a 16:9 aspect ratio and all image areas are protected.
14:9	The FS1-X always inserts a "14:9 (center)" AFD code (11), which indicates that the HD image has a 14:9 aspect ratio as a horizontally centered pillarbox within the 16:9 frame.
4:3 Alt 14:9	The FS1-X always inserts a "4:3 (with alternate 14:9 center)" AFD code (13), which indicates that the HD image has a 4:3 aspect ratio and with an alternative 14:9 centered pillarbox image within the 16:9 frame.
16:9 Alt 14:9	The FS1-X always inserts a "16:9 (with alternative 14:9 center)" AFD code (14), which indicates that the HD image has a 16:9 aspect ratio with an alternative 14:9 center within the 16:9 frame.
16:9 Alt 4:3	The FS1-X always inserts a "16:9 (with alternative 4:3 center)" AFD code (15), which indicates that the HD image has a 16:9 aspect ratio with an alternative 4:3 center within the 16:9 frame.

17.2 AFD VANC Output Lines This parameter determines which video output lines have AFD VANC inserted (HD output only) on the Video Processor output.

10 (default) 9-42	Adds AFD VANC to line 10. Select which line other than 10 will have AFD VANC added.
----------------------	--

17.3 Downcvt AFD Dflt This parameter selects how the Video Processor will operate when parameter 7 Downconvert Mode has been set to Auto AFD and no AFD codes are detected at the selected input source (that is, this menu selects the default Downconversion to use when AFD is absent). This parameter is in effect only when the input is HD (720p, 1080i, or 1080p) and the selected output format is SD (525i or 625i).

Hold Last (default)	Use the last detected AFD code and continue to use its aspect ratio until a new AFD code is detected again in the SDI metadata.
Crop	When AFD code is absent, switch the Downconverter mode to Crop.
Anamorphic	When AFD code is absent, switch the Downconverter mode to Anamorphic.
14:9	When AFD code is absent, switch the Downconverter mode to 14x9.
Letterbox	When AFD code is absent, switch the Downconverter mode to Letterbox.

Closed Captioning This parameter translates closed captioning from the SD CEA-608 format on line 21 to the HD CEA-708 format and inserts it into the HD output video stream.

NOTE: This parameter interacts with parameter 20 SD Line 21 Blanking; see the explanation for that parameter also.

18 Caption Xlator

On (Upconverter)	When set to On and using the Upconverter, the FS1-X will automatically translate incoming line 21 captions to CEA-708 format and insert the VANC packets into the converted HD video stream. This is a complete translation from CEA-608 format to CEA-708 format (including the embedded SD captions).
On (Downconverter)	When set to On and using the Downconverters, the FS1-X will automatically intercept and reformat the SD caption data in the incoming CEA-708 VANC packets, and output it on line 21 of the standard definition outputs.
Off (default)	When Off, caption translation is not performed.

In standard definition video (525i/59.94), closed captioning data is encoded and sent on line 21 of both fields, using a format defined by the Consumer Electronics Association standard, CEA-608. This is traditionally called "line 21", "SD", or "608" captioning, and is used for analog composite, analog component, and serial digital (SDI) video.

In high definition video, closed captioning is encoded and sent as Vertical Ancillary (VANC) packets in SDI video, using a format defined by the Consumer Electronics Association standard CEA-708 (there is no equivalent for analog HD video). This is traditionally called "HD," "DTV," or "708" captioning. The data formatting and encoding for 708 captions is very different from the data contained in 608 (SD) captioning, reflecting the added features and capabilities available with the CEA-708 standard.

When the Caption Translator is on, the FS1-X Upconverter automatically translates incoming line 21 captions to CEA-708 format and inserts the VANC packets into the converted HD video stream. This is a complete translation from CEA-608 format to CEA-708 format (including the embedded SD captions).

The FS1-X Downconverters automatically intercept and reformat the SD caption data in the incoming CEA-708 VANC packets, and output it on line 21 of the standard definition outputs.

Input Scan and PSF

This parameter determines how the Deinterlacer handles interlaced vs. PsF inputs. Normally, this control will only be used to indicate that a 1080PsF25 input is PsF and not interlaced.

- Auto** When Auto is selected, the system will look for clues in the source's SMPTE 352 (Payload ID) data and respond accordingly. If there is no SMPTE 352 information, the system will assume that 23.98/24 fps sources are PsF, and 25/29.97/30 fps sources are interlaced.
- Progressive** When Progressive is selected, the system will assume that all sources are PsF (even if there is SMPTE 352 data to the contrary).
- Interlaced** When Interlaced is selected, the system will assume that all sources are interlaced (even if there is SMPTE 352 data to the contrary)

19.1 Video 1 Input Scan Format

Auto (default)	Deinterlacer detects input source payload ID data and sets the processing format accordingly.
Progressive	Assumes all input sources are progressive.
Interlaced	Assumes all input sources are interlaced.

19.2 Video 2 Input Scan Format

Same settings as above, but affects Video Processor 2.

SD Line 21 Closed Caption Blanking

This parameter determines whether the FS1-X blanks line 21 closed captioning data prior to video processing of an SD 525i video input. (Line 21 normally occurs at the top of the raster in the overscan area of video, so the presence of captioning data or blanking does not interfere with the visible SD or Upconverted video.)

20 SD Line 21 Blanking

- Blank** In Blank mode, the FS1-X copies and remembers the contents of SD line 21 and then blanks those lines before transformation to ensure captioning data does not get included in the transformed video. If the output video is SD 525i, the copied caption information gets reinserted on line 21 of the output. If the output video is Upconverted and parameter 18 Caption Xlator is On, the copied caption gets translated into an HD caption and inserted into the transformed output (and if the caption translator is Off, the HD output does not contain caption data). This is the setting to use if the SD input includes a caption and you want to retain it at the output (parameter 18 Caption Xlator must be On), or you want to blank it at the output (18 Caption Xlator must be Off).
- Pass** In Pass mode, the FS1-X does not blank line 21 of the SD video input and passes the unaltered video to the Video Processor for transformation. This is the setting to use if there is no captioning data present on line 21 of a 525i video input.
- Auto blank** In Auto Blank mode, the FS1-X automatically detects presence or absence of line 21 caption data on the SD input. If no line 21 caption is present, the FS1-X passes the video unaltered. If line 21 data is detected, the FS1-X copies the data, blanks line 21, and reinserts translated captioning on the transformed HD output if parameter 18 Caption

Xlator is On. If the Caption Translator is Off, the HD output will not contain captioning. This is the setting to use if your SD input video sometimes contains captions and other times does not, or if you are uncertain which setting to use.

Blank (default)	In Upconvert or SD Aspect Ratio Convert modes, this setting copies caption data and blanks 525i input video Line 21 caption data before conversion, and may or may not include that data (see above).
Pass	Passes input video unaltered to the converter and to the outputs.
Auto blank	The FS1-X automatically detects caption data on SD input, passing unaltered video if no line 21 caption is present, and reinserting caption data if 18 Caption Xlator is On.

Test Pattern

This parameter selects the video source for the Test Pattern Generator. The pattern generator is turned off and on using Output parameter ["3 Video 1 Output Mode" on page 65](#).

21 Video 1 Test Pattern

75% Bars (default)	Sets the test pattern to 75% bars.
Ramp	Sets the test pattern to ramp.
Multiburst	Sets the test pattern to a multiburst.
Flat Field	Sets the test pattern to flat field chroma.
Black	Sets the test pattern to black.
100% Bars	Sets the test pattern to 100% bars.

Freeze Output

This parameter tells the FS1-X to freeze the current video frame on all outputs. This may be useful either for testing or in case of loss of the input source.

22.1 Video 1 Freeze Output

Off (default)	Normal operation. The FS1-X outputs video from the input.
On	The FS1-X captures and freezes the most current video frame and displays it on the outputs as long as this parameter is set to On.

The freeze feature can be controlled not only by the front-panel and web browser interface, but also by a GPI input. When a GPI input is causing the freeze condition, the EXT lamp will be lit on the front-panel.

22.2 Video 2 Freeze Output

Same settings as above, but affects Video Processor 2.

Reverse Telecine

About Reverse Telecine and Film Cadence (3:2 and 2:3:3:2)

Film cadence is a way to convert film frame rates (24 fps) to 59.94 interlaced field rate video suitable for broadcast, commonly employed by telecine equipment when converting film to video. This requires a 4/5 conversion ratio. For 3:2 pulldown cadence, the most common, two fields are duplicated for every four input frames, with a resulting

2:3:2:3 field output pattern. 3:2 pulldown outputs four fields of original input, then one duplicate field, then four more original fields, and then another duplicate field. This provides the smoothest motion, but results in two of the five video output frames being “dirty”, having fields from different original frames. Another commonly used film cadence is 2:3:3:2, which has only one “dirty” frame but results in motion that is slightly less smooth. Many other more exotic film cadences exist, but they are rarely used.

Film cadence removal reverses pulldown (Reverse Telecine), and can turn interlaced video originally sourced from film with pulldown back to 23.98 progressive frame rate video, removing the duplicated fields. This can be useful for post-production facilities that have a need to accurately re-edit this type of material.

FS1-X Reverse Telecine Conditions

The FS1-X converter can perform film cadence removal under the following conditions:

- Frame Rate Converter must be disabled (or not installed).
- FS1-X input signal must be either 525i59.94 or 1080i59.94.
- FS1-X input signal must have consistent 3:2 or 2:3:3:2 pulldown.
- FS1-X output format selected must be either p23.98 or PsF23.98.
- The Reverse Telecine parameter must be set to Auto.

Under the conditions above, the FS1-X will automatically detect the type of film cadence (3:2 or 2:3:3:2), identify and remove the duplicate fields, and perform motion detection and de-interlacing processing to create high quality output with clean frames.

NOTE: Approximately 10 incoming frames are required before film cadence can be detected and correctly processed. If the cadence pattern changes (for example, the source pulldown video may have been edited) that same approximately 10 frame interval is required after the discontinuity to detect and process the new cadence pattern.

23 Reverse Telecine

Off (default)	Film cadence detection is disabled. This setting should remain Off unless you are processing interlaced pulldown input.
Auto	3:2 and 2:3:3:2 pull down field removal is enabled for interlaced video sources.

VIDEO OUTPUT Menu Group

This menu group selects the Video Processor outputs that are routed to the rear panel connectors.

1.1 SDI1 Video Out

Vid 1 (default)	Sends the output of Video Processor 1 to the SDI1 output.
Vid 2	Sends the output of Video Processor 2 to the SDI1 output.

1.2 SDI2 Video Out

Vid 1	Sends the output of Video Processor 1 to the SDI2 output.
Vid 2 (default)	Sends the output of Video Processor 2 to the SDI2 output.

2.1 Fiber1 Video Out

Vid 1 (default)	Sends the output of Video Processor 1 to the Fiber1 output.
Vid 2	Sends the output of Video Processor 2 to the Fiber1 output.

2.2 Fiber2 Video Out

Vid 1	Sends the output of Video Processor 1 to the Fiber2 output.
Vid 2 (default)	Sends the output of Video Processor 2 to the Fiber2 output.

3 HDMI Video Out

Vid 1 (default)	Sends the output of Video Processor 1 to the HDMI output.
Vid 2	Sends the output of Video Processor 2 to the HDMI output.

4 Analog

This parameter selects the video processor output to be sent out the three *Component* and the single *Composite* analog FS1-X outputs.

Vid 1 (default)	Sends the output of Video Processor 1 to the Analog video outputs.
Vid 2	Sends the output of Video Processor 2 to the Analog video outputs.

Different signals are sent depending on the assigned Video Processor configuration.

- If the video processor assigned is configured for SD output, SD component is sent to the Component outputs, and SD composite is sent to the Composite output.
- If the video processor assigned is configured for HD output, HD is sent to the Component outputs, and SD is sent to the Composite output.
- If the video processor assigned is configured for 3G output, HD is sent to the Component outputs, and SD is sent to the Composite output.

5.1 SDI1 3G Config

The *SDI13G Config* parameter determines how 1080p50/59.94 signals are formatted for the SDI 1 output. The first two choices select either “Level A” or “Level B” as described in the SMPTE 425 standard. The third selection ties SDI 1 Out and SDI 2 Out together into a single 1.5 Gb Dual-link 1080p50/59.94 output. In this case, the SDI2 Video Out and SDI2 Audio Out selections are ignored.

3 Gb-Level A (default)	Formats 3G SDI Output as Level A.
3 Gb Level-B	Formats 3G SDI Output as Level B.
1.5 Gb Dual Link	Formats SDI 1 and SDI 2 as 1.5Gb “Dual Link.”

5.2 SDI2 3G Config

The *SDI2 3G Config* parameter determines how 1080p50/59.94 signals are formatted for the SDI 2 output. The two choices select either “Level A” or “Level B” as described in the SMPTE 425 standard. (If the SDI1 selection is *Dual Link*, these SDI2 settings are ignored because the SDI 2 output is used for dual link.)

3 Gb-Level A (default)	Formats 3G SDI Output as Level A.
3 Gb-Level B	Formats 3G SDI Output as Level B.

6.1 Fiber1 3G Config The *Fiber1 3G Config* parameter determines how 1080p50/59.94 signals are formatted for the Fiber 1 output. The first two choices select either “Level A” or “Level B” as described in the SMPTE 425 standard. The third selection ties Fiber 1 Out and Fiber 2 Out together into a single 1.5 Gb Dual-link 1080p50/59.94 output. In this case, the Fiber2 Video Out and Fiber2 Audio Out selections are ignored.

3 Gb-A (default)	Formats 3G Fiber 1 Output as Level A.
3 Gb-B	Formats 3G Fiber 1 Output as Level B.
1.5 Gb Dual Link	Formats Fiber 1 and Fiber 2 as 1.5Gb “Dual Link.”

6.2 Fiber2 3G Config The *Fiber2 3G Config* parameter determines how 1080p50/59.94 signals are formatted for the Fiber 2 output. The two choices select either “Level A” or “Level B” as described in the SMPTE 425 standard. (If the Fiber1 selection is *Dual Link*, these Fiber2 settings are ignored because the Fiber 2 output is used for dual link.)

3 Gb-Level A (default)	Formats 3G SDI Output as Level A.
3 Gb-Level B	Formats 3G SDI Output as Level B.

AUDIO PROC Menu Group

The following descriptions explain the Audio Proc Menu Groups, which allows you to make adjustments to the audio inputs to the FS1-X audio processor.

The Audio Proc Menus are formatted as follows

Display	Description
MENU # TITLE PARAMETER VALUE PARAMETER VALUE	Menu number and title. Currently selected parameter value for this menu. Higher range parameter value, when required.

1.0 SDI1 Level

This parameter selects the Audio Level Mode for all 16 SDI1 audio input channels. The default Unity setting applies 0.0. db gain to all the input channels

Unity (default)	All 16 SDI1 audio input channels are set to 0.0 dB. Individual channel adjustment menus are hidden.
Adjust	Each of the 16 SDI1 audio input channel adjusted values are applied to the audio processor, and the individual channel adjustment menus become available.

When Adjust mode is selected:

- After selecting an individual channel adjustment menu, the ADJUST knob changes the value shown by 0.5 dB (up or down) for each knob detent.
- The range of adjustment is -18.0dB to +18.0dB.
- Switching from Unity to Adjust will apply the individual level values that were set in the Adjust mode to the input for each of the channels. Switching from Adjust to Unity will apply unity (0.0dB) to all channels.

1.1-1.16 SDI 1 Channel Levels When Adjust is selected above, individual SDI 1 audio channel menus become available, permitting +/- 18.0 dB level adjustment to each input channel.

2.0 SDI1 Phase

This parameter selects the Audio Phase Mode for all 16 SDI1 audio input channels. The default Unity setting applies normal (non-inverted) phase to all the input channels.

Unity (default)	All 16 SDI1 audio input channels are set to Normal phase. Individual channel adjustment menus are hidden.
Adjust	Each of the 16 SDI1 audio input Phase values (either Normal or Invert) are applied to the audio processor, and the individual channel adjustment menus become available.

When Adjust mode is selected:

- After selecting an individual channel adjustment menu, the ADJUST knob toggles the Phase value shown between Normal and Invert. When Invert is selected the phase of the audio input on that channel will be inverted.

Switching from Unity to Adjust will apply the individual Phase values that were set in the Adjust mode to the input for each of the channels. Switching from Adjust to Unity will apply unity (Normal) to all channels.

2.1-2.16 SDI 1 Channel Phase When Adjust is selected above, individual SDI 1 audio channel menus become available, permitting inverting the phase of each input channel.

3.0 SDI1 Delay

This parameter selects the Audio Delay Mode for the eight SDI1 audio input channel pairs. Delay operates on channel pairs only. Delay cannot be adjusted on any single channel. Channel pairs are grouped as: Channel 1 and 2, Channel 3 and 4, ..., Channel 15 and 16. The default Global setting applies the currently set Global delay value to all eight input channel pairs. The factory default Global setting is 0 seconds delay, but whatever value the user changes this setting to will be applied when Global is selected.

Global (default)	All eight SDI1 audio input channel pairs are set to the current Global delay value. Individual channel adjustment menus are hidden.
Channel Pair	Each of the eight SDI1 audio input channel pairs delay values are applied to the input of each channel pair, and the channel pair adjustment menus become available.

When Channel Pair mode is selected:

- Each of the individual eight SDI1 audio input channel pair delay values are applied to the input delay of each channel pair.
- The range of delay is -768 to +12288 in units of samples where 48 samples = 1 millisecond.

Switching from Global to Channel Pair will apply the individual delay values that were set for each individual channel pair. Switching from Channel Pair to Global will apply the same currently set Global delay value to all the channel pairs.

3.1 SDI 1 Delay Global When Global is selected above, the individual SDI 1 audio channel pair menus are hidden.

SDI 1 Delay Global	The ADJUST knob sets the Global delay value. Adjustment range is -768 to +12288 in units of samples where 48 samples = 1 millisecond. The Front Panel displays the delay in milliseconds and as fractions of milliseconds in units of samples.
--------------------	---

3.1-3.8 SDI 1 Channel Pair Delay

When Channel Pair is selected above, eight individual SDI 1 audio channel pair menus become available, permitting adjusting the delay of each input channel pair.

- Delay adjustment range is -768 to +12288 in units of samples where 48 samples = 1 millisecond. The Front Panel displays the delay in milliseconds and as fractions of milliseconds in units of samples.

4.0/5.0/6.0 SDI 2 Level, Phase, Delay

See descriptions for SDI 1:

- ["1.0 SDI1 Level" on page 83](#)
- ["2.0 SDI1 Phase" on page 84](#)
- ["3.0 SDI1 Delay" on page 84](#)

7.0/8.0/9.0 Fiber1 Level, Phase, Delay

See descriptions for SDI 1:

- ["1.0 SDI1 Level" on page 83](#)
- ["2.0 SDI1 Phase" on page 84](#)
- ["3.0 SDI1 Delay" on page 84](#)

10.0/11.0/12.0 Fiber2 Level, Phase, Delay

See descriptions for SDI 1:

- ["1.0 SDI1 Level" on page 83](#)
- ["2.0 SDI1 Phase" on page 84](#)
- ["3.0 SDI1 Delay" on page 84](#)

13.0/14.0/15.0 AES Level, Phase, Delay

See descriptions for SDI 1:

- ["1.0 SDI1 Level" on page 83](#)
- ["2.0 SDI1 Phase" on page 84](#)
- ["3.0 SDI1 Delay" on page 84](#)

16.0/17.0/18.0 MADI BNC Level, Phase, Delay

Same controls as SDI, except can be applied to 64 individual audio inputs, or 32 channel pairs. See descriptions for SDI 1:

- ["1.0 SDI1 Level" on page 83](#)
- ["2.0 SDI1 Phase" on page 84](#)
- ["3.0 SDI1 Delay" on page 84](#)

19.0/20.0/21.0 MADI Fiber Level, Phase, Delay

Same controls as SDI, except can be applied to 64 individual audio inputs, or 32 channel pairs. See descriptions for SDI 1:

- ["1.0 SDI1 Level" on page 83](#)
- ["2.0 SDI1 Phase" on page 84](#)
- ["3.0 SDI1 Delay" on page 84](#)

22.0/23.0/24.0 HDMI Level, Phase, Delay

Same controls as SDI, except can be applied to 8 individual audio inputs, or 4 channel pairs. See descriptions for SDI 1:

- “1.0 SDI1 Level” on page 83
- “2.0 SDI1 Phase” on page 84
- “3.0 SDI1 Delay” on page 84

25.0/26.0/27.0 Analog Level, Phase, Delay

Same controls as SDI, except can be applied to 8 individual audio inputs, or 4 channel pairs. See descriptions for SDI 1:

- “1.0 SDI1 Level” on page 83
- “2.0 SDI1 Phase” on page 84
- “3.0 SDI1 Delay” on page 84

28.0 Mix Down 1 Mode

This parameter activates the Mix Down 1 mixer, and selects either 5.1 or 7.1 mix down mode for that mixer.

Off (default)	Mix down feature is turned off.
5.1 Channel	Selects 5.1 mix down mode.
7.1 Channel	Selects 7.1 mix down mode.

When set to 5.1 or 7.1 Channel Mode, additional menus follow that are used to select the source of the incoming multi-channel audio, adjust the levels of each of the incoming channels to the Left and Right outputs, and adjust the gain of the Left and Right output channels.

About Mix Down Mode Multi-channel audio uses more than two speakers to represent the sound field.

Figure 13. Multi-Channel 5.1 and 7.1 Speaker Positions

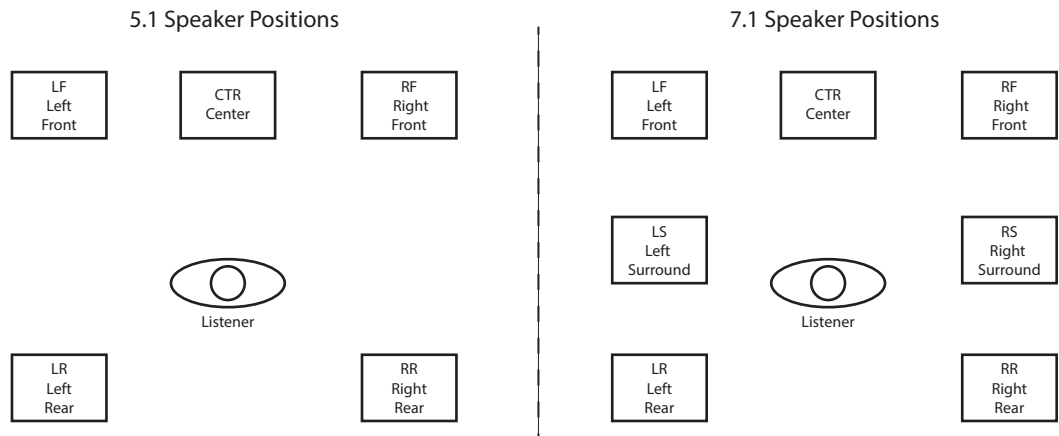

Multi-channel audio, typically embedded in an SDI or HDMI signal, can be passed through the FS1-X converter unchanged. The multi-channel sound can also be mixed down to stereo, using the two Mix Down Modules built into the FS1-X audio processor.

The default FS1-X 5.1 to 2 ch. mix-down equation is:

$$\text{Left Ch Output} = \text{LF} + (-3\text{dB} * \text{CTR}) + (-3\text{dB} * \text{LR})$$

$$\text{Right Ch Output} = \text{RF} + (-3\text{dB} * \text{CTR}) + (-3\text{dB} * \text{RR})$$

The default FS1-X 7.1 to 2 ch. mix-down equation is:

$$\text{Left Ch Output} = \text{LF} + (-3\text{dB} * \text{CTR}) + (-3\text{dB} * \text{LS}) + (-3\text{dB} * \text{LR})$$

$$\text{Right Ch Output} = \text{RF} + (-3\text{dB} * \text{CTR}) + (-3\text{dB} * \text{RS}) + (-3\text{dB} * \text{RR})$$

These default settings can be adjusted using the front panel menus or web interface.

NOTE: The LFE channel is not used in the stereo mix down output, but is passed through the FS1-X audio routing matrix.

28.1 Mix Down 1 Input When 5.1 Channel or 7.1 Channel is selected above, this parameter selects the source of the multi-channel audio coming into that mixer.

SDI 1(default) SDI 2 Fiber 1 Fiber 2 AES/EBU MADI BNC MADI Fiber HDMI	Selects the indicated source. The channel assignments are as follows. All unused channels are muted: Input Ch 1 - Left Front Input Ch 2 - Right Front Input Ch 3 - Center Input Ch 4 - Left Rear Input Ch 5 - Right Rear Input Ch 6 - LFE (not used in mix down output) Input Ch 7 - Left Surround (mute in 5.1 mode) Input Ch 8 - Right Surround (mute in 5.1 mode)
Analog	Selects Analog source channels. Channel assignments same as SDI.
Sig Gen 1KHz Sig Gen 400Hz	Routes the indicates signal generator to all the active multi-channel inputs.
Map	This parameters activates a series of related menus to map a specific input channel to each of the 5 or 7 mixer input channels.

28.2 - 28.8 Mix Down 1 Input Mapping (LF, RF, CTR, LR, RR, LS, RS) When Map is selected above, these menus permit the mapping of any FS1-X audio input channel or signal generator to any of the mixer inputs (L Front, R Front, Center, L Rear, R Rear, and in 7.1 mode L Surround and R Surround). Each mixer input can also be turned Off (muted). Default setting is Off.

28.9 - 28.14 Mix Down 1 Input Level In Mix Down Mode, multi-channel input channels are mixed to the Left and Right output channels. The level of each input signal sent to its mixed output can adjusted plus or minus 18 dB, in half dB increments, using these menu controls.

The default settings are set to the basic equations above, and are listed below.

LF Level	0 dB (unity) to Left output.
RF Level	0 dB (unity) to Right output.
CTR Level	-3 dB from unity to both the Left and Right outputs.
LR Level	-3 dB from unity to the Left output.
RR Level	-3 dB from unity to the Right output.
LS Level (7.1 mode only)	-3 dB from unity to the Left output.
RS Level (7.1 mode only)	-3 dB from unity to the Right output.

NOTE: The LFE channel is not used in the stereo mix down output, but is passed through the FS1-X audio routing matrix.

28.16 - 28.17 Mix Down 1 Output Lft Rt Level The level of the Left and Right mixer output signal can adjusted plus or minus 18 dB, in half dB increments, using these menu controls. Default is 0 dB (unity).

29.0 Mix Down 2 Mode This menu, and the following related parameter menus, have the same controls as for Mix Down 1 Mode, but apply to the Mix Down 2 processor. See ["28.0 Mix Down 1 Mode" on page 86.](#)

30.0 Mix Down Reset

This parameter resets all of the mix down levels (five or seven input, two output) for the selected mixer to the factory defaults.

..

Mix Down 1	Resets the Mix Down 1 mixer levels to default settings.
Mix Down 2	Resets the Mix Down 2 mixer levels to default settings.

34 Embedded Audio Out

This parameter selects whether or not audio is embedded in the SDI1/SDI2/Fiber1/Fiber2 outputs. This setting affects both Video Processors 1 and 2

On	The output of the Audio Processor is embedded in the Video Processor output.
Mute	Audio packets are embedded, but they are set for silence.
Off	No embedded audio (HANC) is generated.

AUDIO OUTPUT Menu Group

The Audio Output Menus control the FS1-X's audio routing. Any audio input can be routed to any output, including embedded audio. The general routing procedure using the FS1-X front panel is to select the menu of the audio output with the Select knob, and then select the input source you wish to route to that output with the Adjust knob. Channel mapping allows different sources to be routed to different outputs

1.0 SDI1 Audio Out

This parameter selects the Audio Input Sources for the SDI1 audio output channels.

The factory default for each output is the corresponding input: i.e. SDI1 to SDI1, SDI2 to SDI2, etc.

SDI1 SDI2 Fiber1 Fiber2 AES/EBU MADI BNC MADI Fiber HDMI Analog	The selected source channels are routed to the corresponding output channels. If the output has more channels than the source, mute (silence) is routed to the higher numbered output channels. If the output has fewer channels than the source, the sources are routed to the lower numbered output channels.
Sig Gen 1KHz Sig Gen 400Hz Mute	The selected tone or mute is routed to every output channel.
Map	The currently configured mapping is applied to each output channel. Channel mapping menus for each output become available.
Mix Down 1 L:R Mix Down 2 L:R	The stereo output of the Mix Down Module (1 or 2) is routed to the SDI output.

When set to SDI1, SDI2, Fiber1, Fiber2, MADI BNC, MADI Fiber, HDMI or Analog:

- The selected source channels are routed to the corresponding output channels. For example, SDI1 input Ch n to SDI1 output Ch n, where n = 1 thru 16.
- If the destination (output) has more channels than the source, then mute (silence) is routed to the channel outputs beyond the source channel range.

- If the destination has fewer channels than the source, then the n channels in the source are routed to the first n channels in the destination, where n is the number of channels in the destination.

When set to Sig Gen 1KHz, Sig Gen 400Hz or Mute:

- The selected source (tone or silence) is routed to every output channel.

When set to Map:

- The mapped source is routed to each output channel according to the last configured mapped source for each channel in the output.
- The following channel map menus become available via the Select knob.

1.1-1.16 SDI1 Output Channel When Map is selected, each listed source can be mapped to each output channel of the currently selected output menu.

SDI1 Output Ch 1 through SDI1 Output Ch 16	Select the source to route to the selected output from the following: -SDI1 Ch1 - Ch16 -SDI2 Ch1 - Ch16 -Fiber1 Ch1 - Ch16 -Fiber2 Ch1 - Ch16 -AES Ch1 - Ch16 -MADI BNC Ch1 - Ch64 -MADI Fiber Ch1 - Ch64 -HDMI Ch1 - Ch8 -Analog Ch1 - Ch8 -Mix Down Ch1 - Ch2 (1.0+) -Sig Gen 1kHz -Sig Gen 400Hz -Mute
--	--

2.0 SDI2 Audio Out See ["1.0 SDI1 Audio Out" on page 88](#)

3.0 Fiber1 Audio Out See ["1.0 SDI1 Audio Out" on page 88](#)

4.0 Fiber2 Audio Out See ["1.0 SDI1 Audio Out" on page 88](#)

5.0 AES/EBU Audio Out See ["1.0 SDI1 Audio Out" on page 88](#)

6.0 MADI BNC Audio Out See ["1.0 SDI1 Audio Out" on page 88](#)

7.0 MADI Fiber Audio Out See ["1.0 SDI1 Audio Out" on page 88](#)

8.0 HDMI Audio Out See "1.0 SDI1 Audio Out" on page 88

9.0 Analog Audio Out See "1.0 SDI1 Audio Out" on page 88

11 Global Output This parameter allows routing the same source or set of sources to all the FS1-X outputs. The rules used for Audio Out apply if the number of outputs do not match the number of inputs.

Off (default)	No Global output configuration is imposed. When Off all other AUDIO OUTPUT menus are enabled and displayed.
SDI1 SDI2 Fiber1 Fiber2 AES/EBU MADI BNC MADI Fiber HDMI Analog	The selected source channels are routed to all the FS1-X output channels. If the output has more channels than the source, mute (silence) is routed to the higher numbered output channels. If the output has fewer channels than the source, the sources are routed to the lower numbered output channels.
Sig Gen 1KHz Sig Gen 400Hz Mute	The selected tone or mute is routed to every FS1-X output channel.
Mix Down 1 L:R Mix Down 2 L:R	The stereo output of Mix Down 1 or Mix Down 2 is routed to all the FS1-X output channels. The Left mixer channel goes to FS1-X output channel 1 and the Right mixer channel goes to output channel 2. If the output has more than two channels (i.e. embedded SDI), mute (silence) is routed to the higher numbered output channels.

NOTE: When any Global Output other than Off has been selected, and Hidden Menus is set to Hide Inactive, no other AUDIO OUTPUT menu group menus will be accessible (they are hidden).

NOTE: No Global Map source is available.

12 Reset Mapped Output This parameter resets the selected output map to the factory default values

Choose a Map (default)	Prompt for selecting an Output to map.
SDI1 SDI2 Fiber1 Fiber2 AES/EBU MADI BNC MADI Fiber HDMI Analog All	After selecting an output, press ADJUST to reset that output to the factory default (i.e. SDI1 to SDI1, SDI2 to SDI2, etc.). All sets all outputs to their factory defaults.

Chapter 5: Browser Remote Control

Remote FS1-X Control Via a Web Browser

The FS1-X web interface consists of a built-in optimized web server that provides control via a web browser running on a network-attached computer. The FS1-X browser screens are presented and described on the following pages, organized as they appear in the browser.

- Supported browsers**
- Chrome (all platforms)
 - Firefox (all platforms)
 - Safari (OSX, Mobile)
 - Internet Explorer (versions 10 and higher)

Other browsers are likely to work but are not guaranteed.

- Supported RJ45 Ethernet network connections**
- Closed local area network (LAN)
 - Straight computer-to-FS1-X cable connection
 - Broadband wide area network (WAN) with the firewall opened for the FS1-X (not recommended since anyone on the internet can then access the FS1-X)

Internally the FS1-X senses and adapts to either a “straight-through” CAT 5 Ethernet cable or null-modem (crossover) cable using standard RJ45 connectors. No setup or strapping is needed to adapt to the cable.

Browser connection For browser access, enter the FS1-X IP address in the browser's address field.

By default, the FS1-X is set to automatically connect to your network's DHCP server to get an IP address and other network configuration data. You will find the IP address in the *CONFIG* Menu Group as follows:

1. Press the *CONFIG* button on the FS1-X front panel.
2. Turn the *SELECT* knob until you reach parameter *IP Address*.
3. Enter the IP address shown in the browser address field.

When the browser successfully connects to the FS1-X, the main *Status* screen shown on the next page is displayed. If the browser fails to connect, make sure *CONFIG* settings for *IP*, *Subnet*, and *Gateway* match the network setup of the browser host. You can either make the computer match the FS1-X, or make the FS1-X match your computer.

General Web Browser Screen Description

The main Status screen appears below. All FS1-X screens have common elements:

- Menu** On the left of each screen is a navigational list of the available FS1-X screens. Click any of these items to jump to that screen.
- Alarms** The lower left side of the screen shows alarms that alert you to possible problem conditions, such as disconnected or failed power supplies and video format incompatibilities.

Status and Menu Display In the center of each screen you'll find the main display showing the status and menu selections for the screen you are viewing. The content of FS1-X web screens closely mirrors the parameter menus displayed on the front panel. On all menus except Status, if you hover the cursor over any parameter, the equivalent front panel parameter number is displayed.

Connection The right side of the screen lists FS1-X system details, including system serial number, installed software version, and connection status. This information is useful if you ever have to call AJA Technical Support for help.

Network The right side of the screen lists systems on the network. If you right-click any FS1-X system in the list and select Identify, the ID LEDs on the unit will blink to identify it. Click on Identify again to stop the blinking. Another way to identify systems is to notice which FS1-X system's EXT front panel LED flashes when you change any setting from a remote control device, such as the web browser.

Figure 14. FS1-X Web Interface, Main Status Screen



Controlling Multiple FS1-Xs

From any screen, you can see at-a-glance all of the FS1-X devices present on the same local LAN as well as the current FS1-X you are controlling. Clicking on any of the listed systems will bring up the *Status* screen of that FS1-X.

NOTE: *The FS1-X you control may be running a different software version, so screens may look different. It's a good idea to have all your FS1-X devices running the most current software and the same version. Also, if the Default Gateway (parameter 2.4) is not configured properly,*

other FS1-Xs will not be visible. If the display shows No FS1-X's found, check the gateway setting.

Resetting Values To Factory Settings

FS1-X web browser screens feature many user controls that can be reset to factory values by simply "right-clicking" on the parameter label. When you right-click, the browser displays a *Reset to Factory* message that will cause the parameter to be reset.

NOTE: *This reset procedure only works with computers that allow right-clicking. Some computers may not permit this operation.*

You can perform a global reset to factory values of all System, Video, Audio, and most Config parameters (the same set of parameters acted on by a Preset Recall).

To perform a global reset:

1. Go to the *Presets* screen.
2. Click on the *Recall* button in the *Factory Preset* row.

User preferences, network settings, and existing Presets are not affected by recalling the Factory Preset.

Drop Down Parameter Operation

Most FS1-X parameters available on the browser are selected from a drop-down list. The currently active parameter is displayed. Click on the down arrow symbol next to the parameter to display the list and select an alternative value. The FS1-X will immediately operate with the new setting.

Slider Operation

Some screens contain slider controls for setting values. To set a value, you can click on a slider to select it and then use the mouse to drag the slider to the position you desire. For fine tuning, while the slider is selected (highlighted by a blue border), use the keyboard left and right arrow keys to change the value one unit at a time. After setting a slider's position, click on the page's background area (blue highlight turns off) to ensure the change is confirmed and saved.

Sub-Menus

Some parameters, when activated, open sub-menus. The sub-menus are a lighter gray color and have a collapse/expand button on the parent selection. This lets you collapse the sub-menus to make it easier to configure the system. The collapsed setting only stays in effect until the user reconnects or refreshes the browser.

Screen Descriptions

Now that you have had an introduction to how the FS1-X browser works and how to navigate the screens, each screen and its settings are described in detail. The screens are described in the order listed on main screen (click to jump):

- ["Network Pane and Network Configuration Screen" on page 94](#)
- ["Alarm Configuration Screen" on page 96](#)
- ["Status Screen" on page 97](#)
- ["System Screen" on page 98](#)
- ["Config Screen" on page 99](#)
- ["Presets Screen" on page 101](#)
- ["Video Proc Screen" on page 103](#)

- “Video Output Screen” on page 104
- “Audio Proc Screen” on page 105
- “Audio Output Screen” on page 106
- “Remote Screen” on page 107
- “Firmware Screen” on page 108

Network Pane and Network Configuration Screen

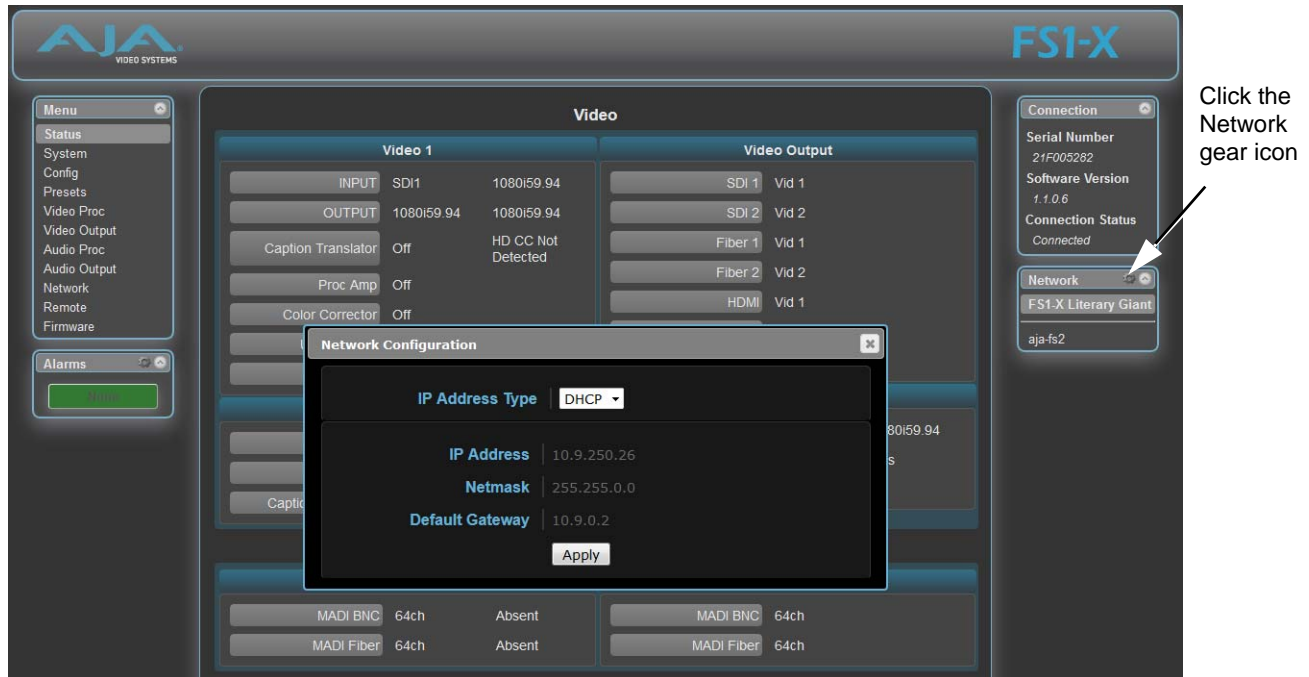

The *Network* pane on the right side of any screen lists the FS1-X systems that appear on the network. This pane includes three additional controls:

- Hover the cursor over any system name to see its IP address.
- Right-click any system and select *Identify* to blink the system *ID* LEDs.
- Click the gear-shaped icon in the *Network* pane (or select *Network* from the *Menu* list on the left side of the screen) to open the *Network Configuration* screen listing FS1-X network settings.

The *Network Configuration* screen allows you to view and change your FS1-X's network settings and then click *Apply* to activate them.

See “[Networking](#)” on page 30 for detailed setup instructions for connecting the FS1-X to a network. Consult your network administrator about how to configure network settings.

IP Address Type

IP Address Type determines the type of TCP/IP network configuration used by the FS1-X. *DHCP* enables the FS1-X to connect to the network DHCP server, which assigns the *IP Address*, *Netmask*, and *Gateway* automatically. *Static* lets you set these parameters manually.

NOTE: If the *IP Address Type* is *DHCP*, the *IP Address*, *Netmask*, and *Default Gateway* are gray, indicating they are set automatically and cannot be changed unless *IP Address Type* is first set to *Static*. Changes are saved and activated upon confirmation using the *Apply* button.

DHCP (default)	Select automatic IP address assignment from the LAN DHCP server. If the FS1-X cannot find a DHCP server, it fails over to the static IP address.
Static Addr	Assign a static IP address manually (using parameters 2.2, 2.3, and 2.4). The factory default static IP address: 192.168.0.2

IP Address

IP Address determines the static IP address used by the FS1-X for TCP/IP networking. (Networking is discussed in *Chapter 3, Network Connection*.) Consult your network administrator about how to set this value.

Variable	If <i>IP Address Type</i> is set to <i>DHCP</i> , the IP address is set automatically by the network DHCP server and cannot be entered here. If <i>IP Address Type</i> is set to <i>Static</i> , enter an IP address compatible with your LAN here. Also enter a netmask and default gateway address in the following two parameters. Click <i>Apply</i> when you are ready to apply all three entries to change the FS1-X's network addressing. If <i>IP Address Type</i> is set to <i>DHCP</i> and there is a DHCP failure, the IP address is set to the static IP address. The default static IP address is 192.168.0.2
----------	--

Netmask

Netmask determines the subnet mask used by the FS1-X for TCP/IP networking.

Variable	Enter a subnet mask compatible with your LAN. This is only needed for Static IP configurations. The factory default <i>Subnet Mask</i> is 255.255.255.0 If <i>IP Address Type</i> is set to <i>DHCP</i> , the Subnet Mask is set by the DHCP server and cannot be changed by the user.
----------	---

Default Gateway

Default Gateway determines the gateway or router used on your LAN for TCP/IP networking.

Without a properly configured default gateway (whether you have a router/gateway or not), the FS1-X will be unable to see other FS1-Xs on the network, although you may still be able to control this FS1-X via a web browser. Also, without a proper gateway defined, the discovery feature on the *Network* web page will not work correctly and list other FS1-Xs on the network.

Variable	Enter a default gateway or router address. This is only needed for Static IP configurations. The factory <i>Default Gateway</i> is 192.168.0.1. If <i>IP Address Type</i> is set to <i>DHCP</i> , the Default Gateway is set by the DHCP server and cannot be changed by the user.
----------	---

Alarm Configuration Screen

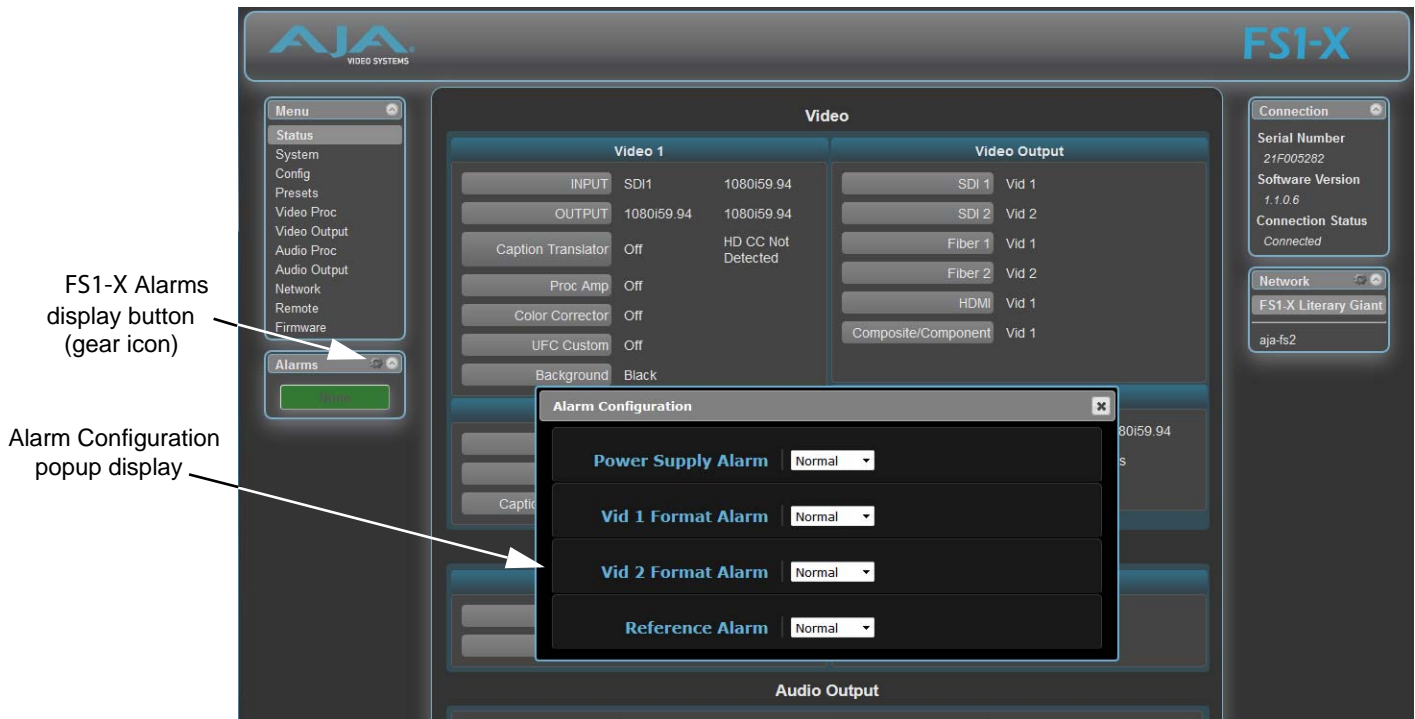

You can pop open the *Alarm Configuration* display at any time and on any screen by clicking the gear button in the upper part of the *Alarms* panel.

To close the window, press the ESC key, or click the X in the upper right corner.

The *Alarm Configuration* display provides control over these alarm settings:

- Power Supply Alarm (see [“5 Power Supply Alarm” on page 56](#))
- Video 1 and Video 2 Format Alarm (see [“6.1 Vid1 Format Alarm” on page 56](#))
- Reference Alarm (see [“7 Reference Alarm” on page 57](#))

Status Screen



The Status screen displays overall FS1-X operational status. You can right-click most video values to change them, allowing you to edit many parameters in one place. Parameters with format incompatibilities or other alarms are highlighted in red.

Video 1	INPUT OUTPUT Caption Translator Proc Amp Color Corrector UFC Custom Background	Shows the input source and format for Video Processor 1. Shows the output video selection and format for Video Proc 1. Shows the caption selection and caption signal presence. Shows whether the Proc Amp is On or Off. Shows whether the Color Corrector (RGB) is On or Off. Shows whether Custom conversion, AFD, and ROI are On or Off. Shows the source and format of Background video.
Video 2	INPUT OUTPUT Caption Translator	Shows the input source and format for Video Processor 2. Shows the output video selection and format for Video Proc 2. Shows the captioning selection and signal presence.
Video Output	SDI 1 SDI 2 Fiber 1 Fiber 2 HDMI Composite/Component	Shows which processor is feeding the SDI 1 output. Shows which processor is feeding the SDI 2 output. Shows which processor is feeding the Fiber 1 output. Shows which processor is feeding the Fiber 2 output. Shows which processor is feeding the HDMI output. Shows which processor is feeding the Composite or Component output. Only one output can be active a time.
Genlock-FRC	Genlock Source FRC Option	Shows the source of the genlock reference, and its format. Shows the presence and operating status of the FRC option.

MADI	MADI Inputs	Indicates the Mode (64 or 56 channels) and input signal Status of the MADI BNC and Fiber ports.
	MADI Outputs	Indicates the Mode (64 or 56 channels) and output signal Status of the MADI BNC and Fiber ports.
Audio Output	Global Audio Output	Right-clicking on the Global Audio Out parameter lets you select a global output. That same audio will be sent to all the FS1-X audio outputs. When set to Off, the other Audio Outputs display their selected value, otherwise only the Global Audio Output setting is displayed.
	SDI 1 SDI 2 Fiber 1 Fiber 2 HDMI MADI MADI Fiber AES Analog	Each of these settings, when visible, reports the audio that is currently being routed to that audio output. Mute and Sig Gen is reported when all of that port's outputs have that setting. Map is reported when the port's outputs are mapped.

System Screen

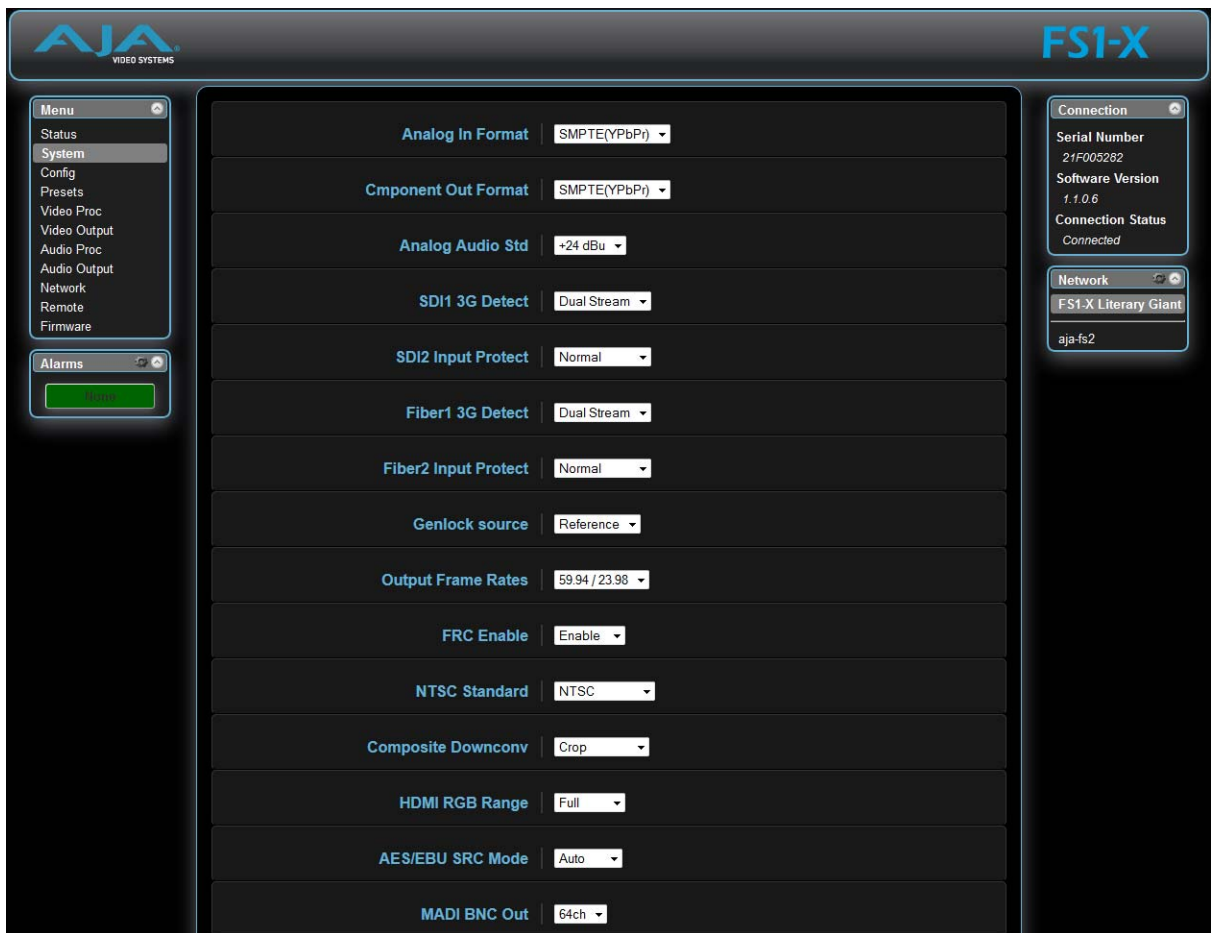

The *SYSTEM* web interface screen includes parameters for setting up various FS1-X system related features (video formats, audio level standards, etc.).

The *System* screen parameters are identical to those available on the FS1-X front panel. These include:

- “1 Analog In Format” on page 59
- “2 Component Out Format” on page 59
- “3 Analog Audio Std” on page 59
- “4 SDI1 3G Detect” on page 59
- “5 SDI2 Input Protect” on page 60
- “6 Fiber1 3G Detect” on page 61
- “7 Fiber2 Input Protect” on page 61
- “8 Genlock Source” on page 61
- “9 Output Frame Rates” on page 61
- “10 FRC Enable” on page 61
- “11 NTSC Standard” on page 62
- “12 Composite Downconv” on page 62
- “13 HDMI RGB Range” on page 62
- “14.0 AES/EBU SRC Mode” on page 63
- “15.1 MADI BNC Out” on page 64
- “15.1 MADI Fiber Out” on page 64

Config Screen

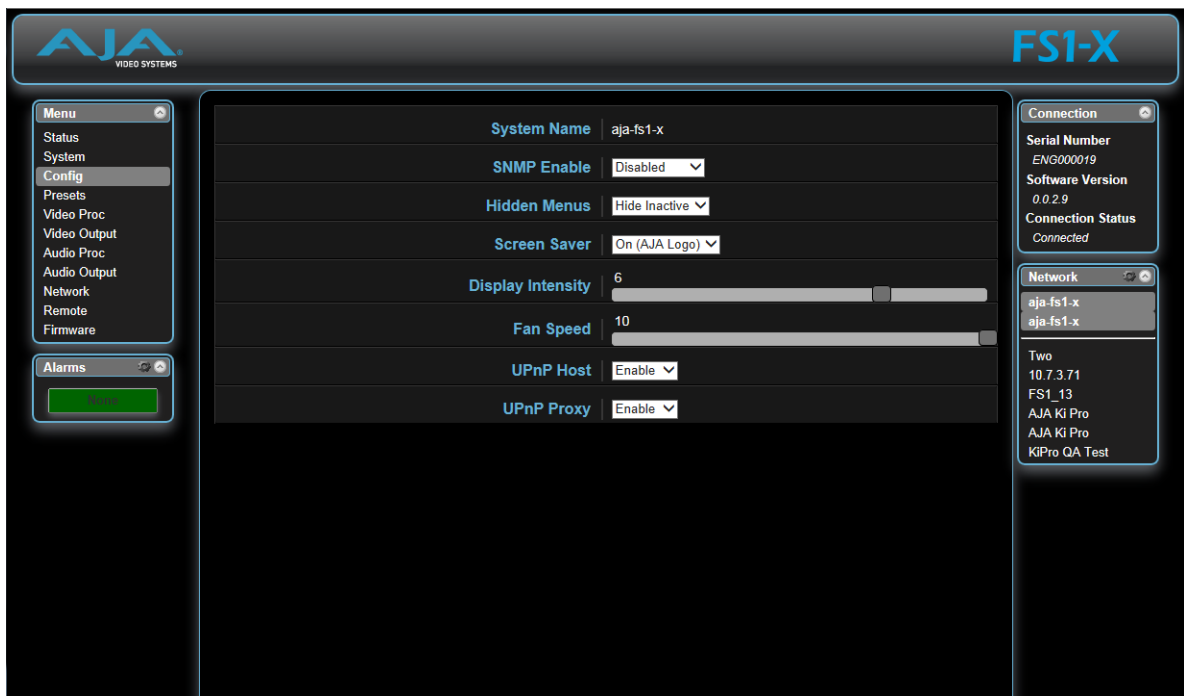

The *Config* screen includes functions to name the FS1-X, configure SNMP, hide or show unused menus, change the front panel display brightness and FS1-X fan speed, and configure UPnP.

System Name

The System Name parameter sets the name of the FS1-X system. To change the System Name, click on and drag the cursor across the displayed name, and type in a new name.

Variable	Highlight the existing name and type in a new name, up to 20 characters. Allowed characters are A-Z, a-z, numerals, hyphen, and period.
----------	---

SNMP Parameters

The following parameters are used to setup the FS1-X SNMP (Simple Network Management Protocol) feature.

- SNMP Enable
- SNMP Trap Dest 1
- SNMP Trap Port 1
- SNMP Trap Dest 2
- SNMP Trap Port 2

In addition, the following alarms may affect SNMP messages:

- Power Supply Alarm
- Video1 Format Alarm
- Video 2 Format Alarm
- Reference Alarm

Refer to "[Chapter 6: SNMP on page 109](#)" for a description of SNMP and how the FS1-X supports it.

Hidden Menus

This selection lets you choose whether to hide or show inactive menus.

Hide Inactive (default) Show All	Hides menus that are not in use. Shows all menus, even those that are not in use.
-------------------------------------	--

Display Intensity

Display Intensity determines alphanumeric display and front panel LED brightness.

Variable	Use the slider to dim or brighten the alphanumeric display and activity indicator LEDs in steps from 1 (dim) to 8 (brightest). Default is 6
----------	---

UPnP Host

UPnP Host enables the FS1-X to be discovered by a Windows network.

Enable (default) Disable	Enables the FS1-X to be discovered by a Windows network. Disables Windows network discovery of the FS1-X.
-----------------------------	--

When this parameter is enabled, you can view the FS1-X on a Windows Network by clicking these selections in Windows 7: *Start > Computer > Network* (in left pane). Any FS1-Xs on the network will be listed under *Other Devices* below *Computers* and *Media Devices*. If your system does not have network discovery enabled, you may need to enable it following the Windows help instructions to make network devices visible in the Windows Network window.

UPnP Proxy

UPnP Proxy enables the FS1-X to serve as a proxy for other AJA devices, allowing them to be discovered on a Windows network through the FS1-X. When enabled, the FS1-X acts as a proxy for all the AJA devices that it is able to connect to that have not already been discovered on the network. The devices will be listed in the FS1-X Network window. Once the devices appear on the network, they can connect directly to other devices and computers without involving the FS1-X.

Enable (default)	Enables the FS1-X to connect other AJA devices to the network.
Disable	Disables the FS1-X from serving as a proxy for AJA devices.

Presets Screen

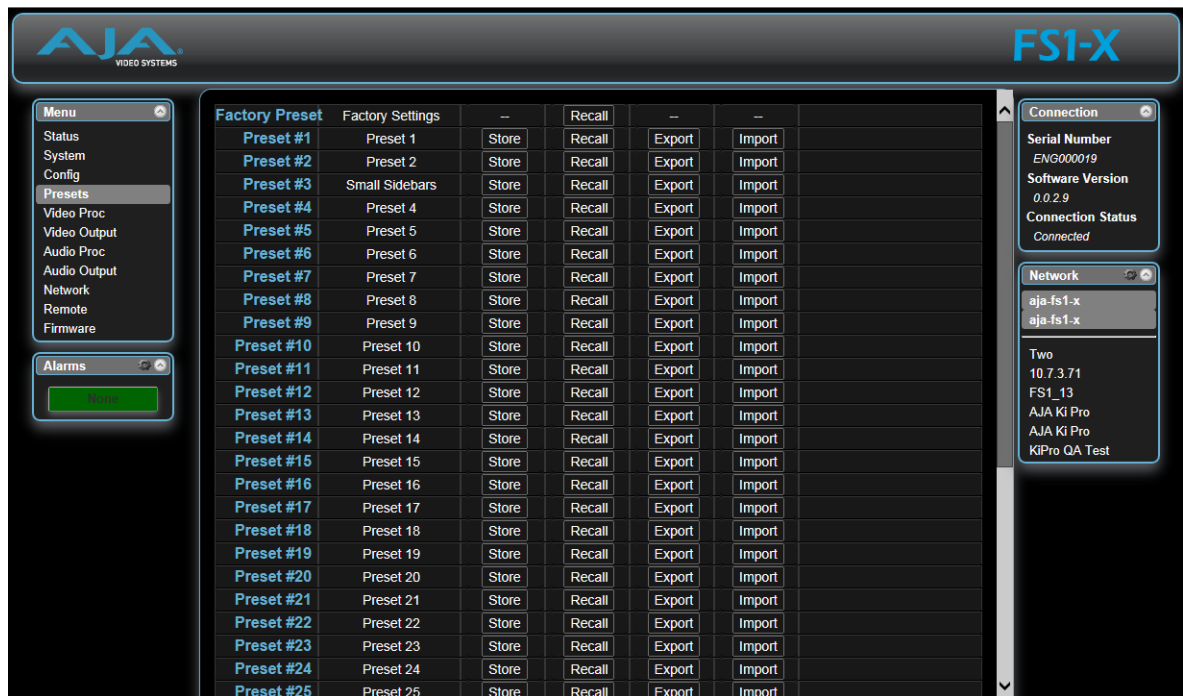

The *Presets* screen allows you to save FS1-X Preset Configurations into 40 separate memory registers and recall the presets whenever needed. This screen also includes Export and Import functions that allow exporting one or all FS1-X presets to your computer as files and importing exported preset files from your computer. A displayed message indicates successful or failed saves, recalls, exports, and imports.

Presets Screen Controls

Factory Preset *Factory Preset* recalls all editable video and audio parameters to their factory default settings. Individual presets, user preferences, and Network settings, such as the IP Address, are not affected.

Recall The *Recall* buttons recall saved FS1-X preset configurations.

	<p>Caution! When you recall a Preset Configuration, the recalled preset immediately replaces the system's existing configuration. All previous settings are lost unless you have previously stored them in another preset configuration or an exported file.</p>
---	---

Store The *Store* buttons let you save the current FS1-X configuration into the preset register with the associated name and number. A preset is a set of all System, Video, Audio, and Output parameters as they were set at the time the preset was stored. Only editable parameters are saved in the presets. Non-editable parameters are **not** saved.

To change a preset name, click in the name's text field and type a new name.

Export The *Export* buttons save the associated preset contents to a file on your computer. The file gets exported to the default download location specified in your browser options. The file name is the same as the preset name with the suffix *.presets*. If you export multiple files for the same preset, a number gets appended to ensure a unique file name. The file size is small, usually less than 100 kilobytes.

Import The *Import* buttons let you browse for and import a preset file on your computer into the preset register associated with the selected button. A dialog box warns you that the operation will overwrite the current preset contents with the file contents.

Export Presets 1–40 (All) *Export All* lets you save the contents of all presets to a file on your computer. The file gets exported to the default download location specified in your browser options with the name *all.presets*. If you export multiple files, a number gets appended to ensure a unique file name.

Import Presets 1–40 (All) *Import All* lets you browse for and import a previously exported *all.presets* file from your computer. A dialog box warns you that the operation will overwrite all 40 current preset contents with the contents stored in the file.

Interaction of Presets and GPIs

Triggering presets using GPI inputs offers considerable power but also requires some care to avoid unexpected results. If you plan to trigger presets using GPIs, please see the information about the [“Interaction of Presets and GPIs” on page 54](#).

Video Proc Screen

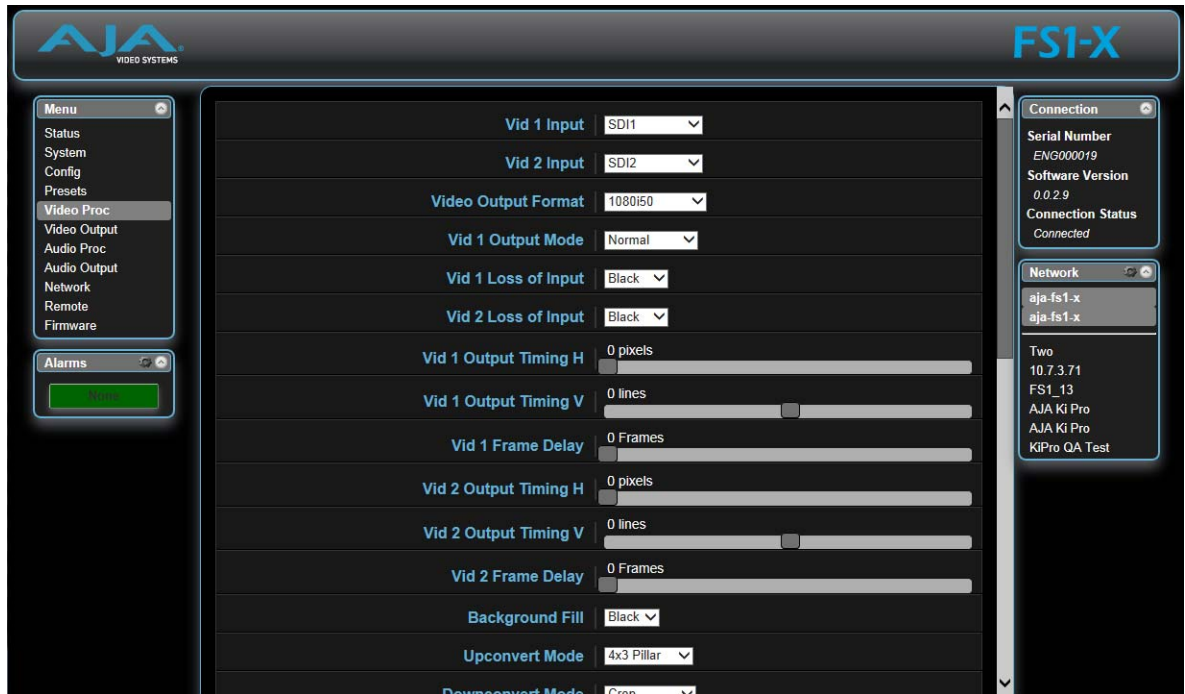

The Video Proc screen selects the video sources that are routed to Video Processor 1 and Video Processor 2, and controls the FS1-X's video signal processing.

The parameters available on the Video Proc browser screens are essentially identical to the front panel display menus. The only difference is parameters are set using webpage controls (drop down menus, slider adjustments) instead of control knobs.

Complete descriptions of these parameters are accessible using the following cross references:

- ["1.1 Video 1 Input" on page 64](#)
- ["1.2 Video 2 Input" on page 65](#)
- ["2 Output Format" on page 65](#)
- ["3 Video 1 Output Mode" on page 65](#)
- ["Loss of Input" on page 65](#)
- ["Timing and Delay" on page 66](#)
- ["6 Background Fill" on page 67](#)
- ["7 Upconvert Mode" on page 68](#)
- ["8 Downconvert Mode" on page 69](#)
- ["9 SD Aspect Ratio Convert" on page 70](#)
- ["10 Sidebar Edge" on page 71](#)
- ["Matte of Background Fill" on page 72](#)
- ["Proc Amp Controls \(YUV\)" on page 72](#)
- ["Color Corrector \(RGB\)" on page 73](#)
- ["Custom Conversion Settings" on page 73](#)
- ["Region of Interest \(ROI\)" on page 75](#)
- ["Video Legalizer" on page 75](#)

- [“AFD” on page 76](#)
- [“18 Caption Xlator” on page 78](#)
- [“Input Scan and PSF” on page 79](#)
- [“20 SD Line 21 Blanking” on page 79](#)
- [“21 Video 1 Test Pattern” on page 80](#)
- [“Freeze Output” on page 80](#)

Video Output Screen

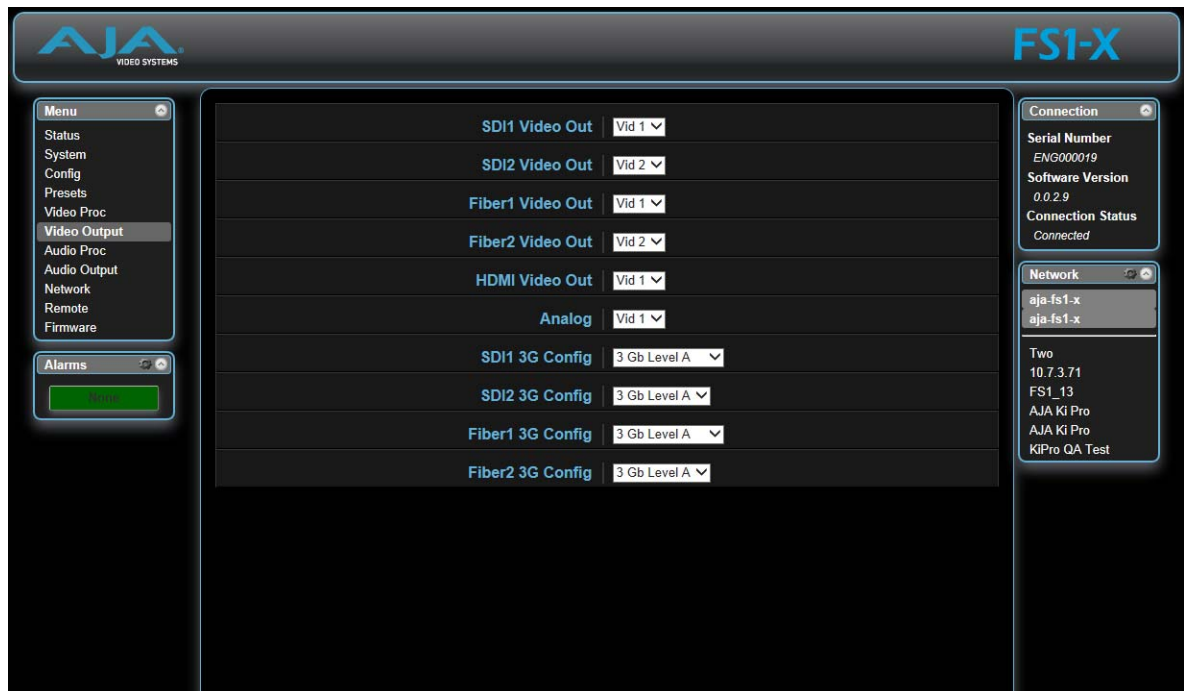

The Video Output screen selects the Video Processor outputs that are routed to the rear panel connectors.

The parameters available on the Video Output browser screen are identical to the front panel display menus. Complete descriptions of these parameters are accessible using the following cross references:

- [“1.1 SDI1 Video Out” on page 81](#)
- [“1.2 SDI2 Video Out” on page 81](#)
- [“2.1 Fiber1 Video Out” on page 82](#)
- [“2.2 Fiber2 Video Out” on page 82](#)
- [“3 HDMI Video Out” on page 82](#)
- [“4 Analog” on page 82](#)
- [“5.1 SDI1 3G Config” on page 82](#)
- [“5.2 SDI2 3G Config” on page 82](#)
- [“6.1 Fiber1 3G Config” on page 83](#)
- [“6.2 Fiber2 3G Config” on page 83](#)

Audio Proc Screen

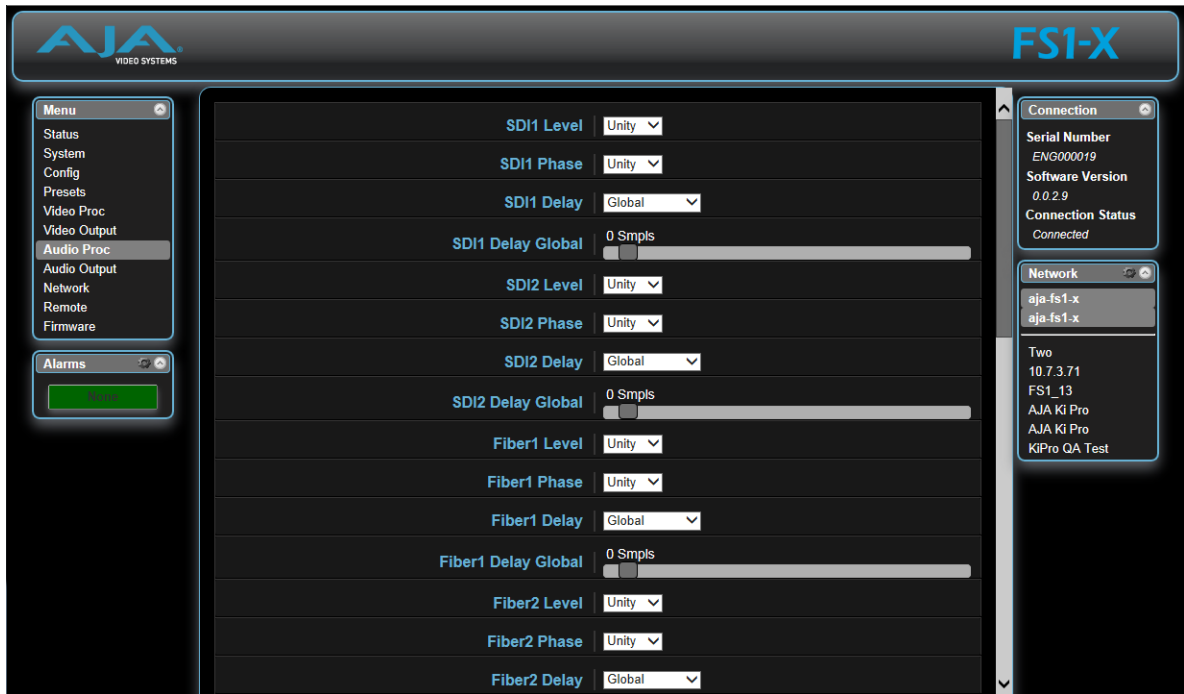

The *Audio Proc* browser screen displays the audio control selections for the audio inputs, audio signal generator, and embedded audio.

The parameters available on the Audio Proc browser screens are essentially identical to the front panel display menus. The only difference is parameters are set using webpage controls (drop down menus, slider adjustments) instead of control knobs.

NOTE: Selecting **Adjust** or **Channel Pairs** will apply whatever individual settings were previously set for the individual channels or channel pairs, and brings up individual sub-menu controls, to allow making changes to those settings. The sub-menus are a lighter gray color and have a collapse/expand button on the parent selection. This lets you collapse the sub-menus to make it easier to navigate the menu while configuring the system. The collapsed setting only stays in effect until the user reconnects or refreshes the browser.

Descriptions of these parameters are accessible using the following cross references:

- [“1.0 SDI1 Level” on page 83](#)
- [“2.0 SDI1 Phase” on page 84](#)
- [“3.0 SDI1 Delay” on page 84](#)

NOTE: The same basic adjustment procedures for SDI Audio Level, Phase, and Delay are also used for Fiber, AES, MADI, HDM, and Analog.

- [“28.0 Mix Down 1 Mode” on page 86](#)
- [“30.0 Mix Down Reset” on page 88](#)
- [“34 Embedded Audio Out” on page 88](#)

Audio Output Screen

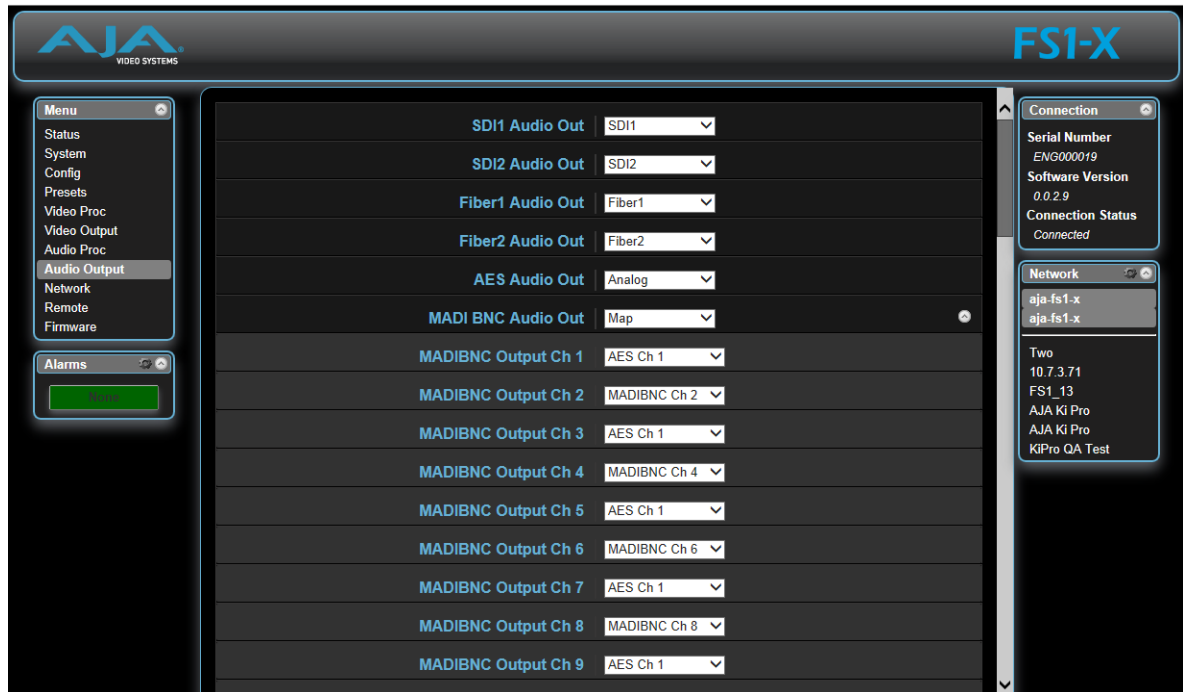

The *Audio Output* browser screen displays the controls used for audio routing. Any audio input can be routed to any output, including embedded audio.

The parameters available on the Audio Proc browser screens are essentially identical to the front panel display menus. The only difference is parameters are set using webpage controls (drop down menus) instead of control knobs.

NOTE: *On the web browser, Selecting **Map** for any Output will apply whatever individual mappings were previously set for that item, and brings up individual sub-menu controls, to allow making changes to those settings. The sub-menus are a lighter gray color and have a collapse/expand button on the parent selection. This lets you collapse the sub-menus to make it easier to navigate the menu while configuring the system. The collapsed setting only stays in effect until the user reconnects or refreshes the browser.*

Descriptions of these parameters are accessible using the following cross references:

- [“1.0 SDI1 Audio Out” on page 88](#)

NOTE: *The same basic adjustment procedures for SDI Audio Out are also used for Fiber, AES, MADI, and HDMI audio routing.*

- [“11 Global Output” on page 90](#)
- [“12 Reset Mapped Output” on page 90](#)

Remote Screen

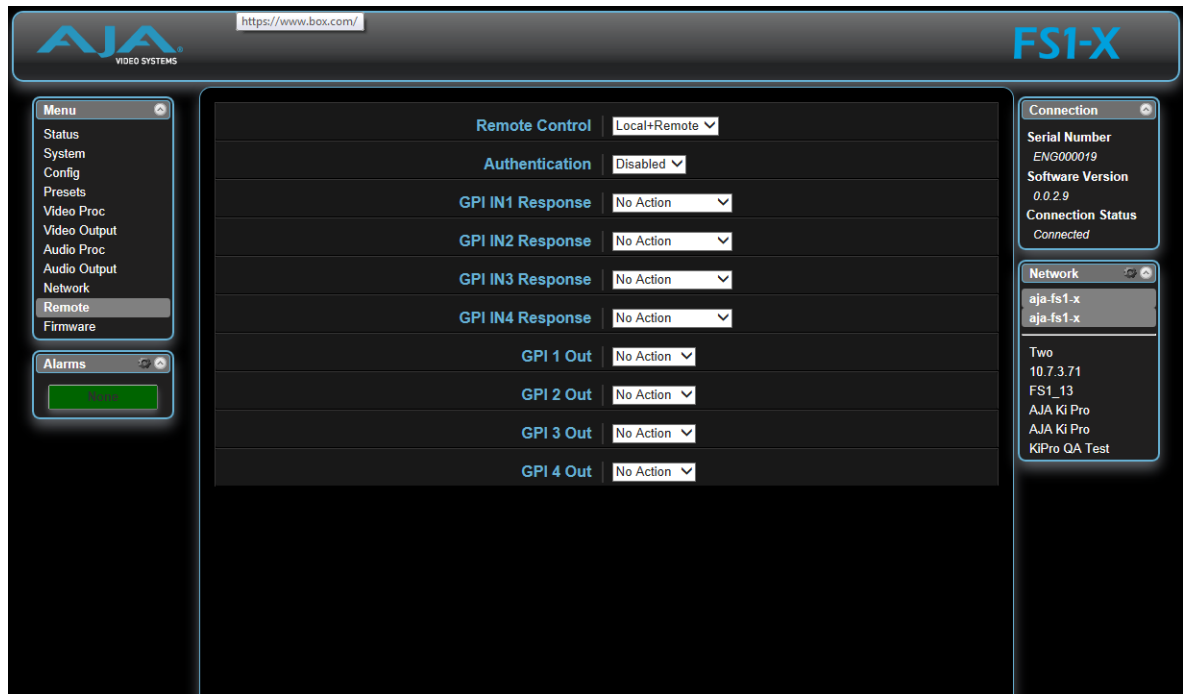

The *REMOTE* screen contains parameters that affect how the FS1-X is controlled. Control options include the front panel, a remote computer running a browser, and GPI inputs and outputs.

NOTE: *The Remote Menu Group parameters available on the front panel interact with the browser parameters available on an attached computer, and vice versa. For example, the Remote Control parameter can only be changed from the front panel, and when set to Local Only will deactivate all browser remote control parameters.*

See [“REMOTE Menu Group” on page 51](#) for detailed information about FS1-X remote control options.

Firmware Screen

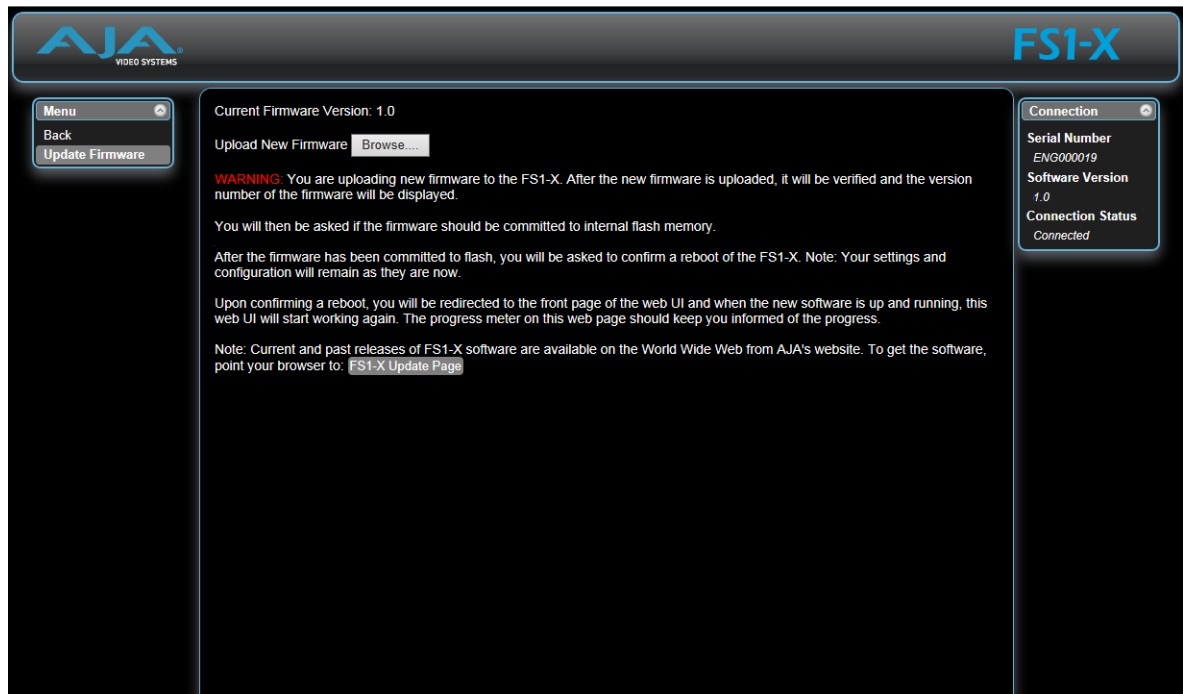

The *Update Firmware* screen allows you to download and install a firmware update from AJA.

First visit the AJA website (aja.com) to locate and download the updated software. The following page provides FS1-X support information and will include links to locations where you can download updates:

<http://www.aja.com/en/products/FS1-X/#support>

After downloading the software update to your local drive, use the *Browse* button to locate the local software copy. Follow the prompts to load the new firmware into the FS1-X. See *“Software Update Installation” on page 34* for more information.

Chapter 6: SNMP

FS1-X Simple Network Management Protocol

SNMP is defined as a “simple network management protocol” and was specified as a component of the internet protocol suite by the Internet Engineering Task Force (IETF). The FS1-X can act as a *network element* that issues SNMP trap messages signaling a detected alarm condition or other system condition. A device’s trap messages are defined in an MIB (Management Information Base) file. The trap messages are sent to a server-based external NMS destination. For example, the FS1-X could send a trap message if one of its redundant power supplies becomes unplugged. A client software agent that communicates with the NMS might then get a message telling the operator what has happened.

The FS1-X must be configured for SNMP messaging. By default SNMP is disabled on the FS1-X. Besides activating SNMP, trap destinations must also be defined with fixed IP addresses.

When SNMP is enabled, one or more of these alarms may be sent by the FS1-X to the client network management system (NMS) as a trap message:

- FS1-XPowerSupplyAlarm (PS1 Alarm)
- FS1-X PowerSupply2Alarm (PS2 Alarm)
- FS1-XReferenceAlarm (Ref Video Alarm)
- FS1-XVid1ReferenceAlarm (Vid1 Ref Video Alarm)
- FS1-XVid2ReferenceAlarm (Vid2 Ref Video Alarm)
- FS1-XVid1FormatAlarm (Vid1 Format Alarm)
- FS1-XVid1BackgroundAlarm (Vid1 Background Format Alarm)
- FS1-XVid2FormatAlarm (Vid2 Format Alarm)
- FS1-XVid2BackgroundAlarm (Vid2 Background Format Alarm)
- FS1-XOverTemperatureAlarm (FS1-X Over Temperature Alarm)

SNMP Configuration

FS1-X SNMP configuration can be accomplished using the front panel or with the web browser computer interface (if Remote Control is enabled).

Front Panel Screens

The FS1-X front panel screens for SNMP are accessible through the CONFIG button. The direct SNMP configuration screens are:

- 4.0 SNMP Enable
- 4.1 SNMP Trap Destination 1
- 4.2 SNMP Trap Port 1
- 4.3 SNMP Trap Destination 2
- 4.4 SNMP Trap Port 2

These SNMP direct configuration parameters are described later in this chapter.

In addition, the following front panel CONFIG screens can affect SNMP alarm messaging:

- 5.0 Power Supply Alarm (see [page 56](#)).
- 6.1 & 6.2 Video Format Alarm (see [page 56](#)).
- 7 Reference Alarm (see [page 57](#)).

Front Panel Octet Value Entry Procedure

Set the octets (numbers between periods) values as follows:

1. Push *ADJUST* momentarily to enter edit mode.
2. Turn *SELECT* to select the octet you want to edit, indicated by blinking.
3. Turn *ADJUST* to enter the new value.
 - If you need to revert to the previous setting (undo changes), push *SELECT*.
4. Push *ADJUST* momentarily to save and activate the new setting.
 - If you want to revert to the default value, hold down *ADJUST* for 4 seconds.

Web Browser

SNMP direct configuration settings are available on the Config screen of the web browser interface.

Figure 15. Web Browser Config Screen SNMP Parameters



Clicking on the Alarms gear icon opens a window that permits setting alarm messaging.

Figure 16. Web Browser Alarm Configuration Window

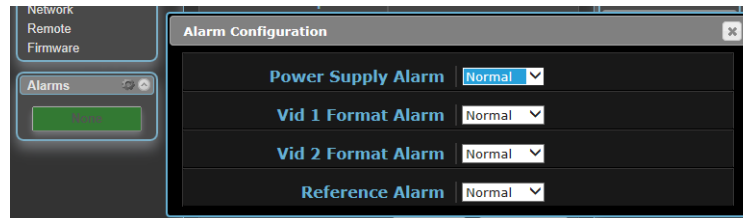

SNMP Configuration Parameters

4.0 SNMP Enable

The *SNMP Enable* parameter Enables or Disables SNMP messaging between the FS1-X and an external client.

Disabled (<i>default</i>)	When set to <i>Disabled</i> , the FS1-X will not issue SNMP trap messages.
Enable 1	When set to <i>Enable 1</i> , the FS1-X issues SNMP trap messages to Trap Destination 1 (parameter 4.1) and as defined in the MIB.
Enable Both	When set to <i>Enable Both</i> , the FS1-X issues SNMP trap messages to Trap Destination 1 and 2 (parameters 4.1 and 4.3) and as defined in the MIB.

When Enabled, menus described below are available for configuration.

4.1 SNMP Trap Destination 1

This parameter determines the *SNMP Trap Destination* IP address where trap messages issued by the FS1-X will be sent.

IP Address	Set the desired IP address where traps will be sent (usually a client on your LAN). <i>Default: 192.168.0.3</i>
------------	---

4.2 SNMP Trap Port 1

This parameter determines the *SNMP Trap Port 1* used for sending destination #1 trap messages. UDP Port 162 is the default used for SNMP trap messages. However, if this port is being used by another protocol or service, you can change the setting by modifying this parameter.

Variable	Select a UDP port for sending FS1-X trap messages. <i>Default: 162</i>
----------	--

NOTE: The SNMP Trap Port number does not blink when changed (as does the Trap Destination IP address); if you change the port number and exit the parameter, the port changes immediately to the new value.

4.3 SNMP Trap Destination 2

This parameter determines the secondary *SNMP Trap Destination* IP address where trap messages issued by the FS1-X will be sent (if desired). This parameter is similar to "[4.1 SNMP Trap Destination 1](#)" above. The default is 192.168.0.3.

4.4 SNMP Trap Port 2

This parameter determines the *SNMP Trap Port* used for sending destination #2 trap messages, similar to "[4.2 SNMP Trap Port 1](#)" above. Default is 162.

Appendix A: Specifications

Video Input/Output Formats

The FS1-X supports a wide variety of video formats and connectors, as listed below.

Format Exceptions The following formats are not supported:

- 720p/23.98/24/25/29.97
- All 30/60 frame rates
- 4:4:4 YCbCr, RGB, or XYZ inputs
- 4:2:2 YCbCr 12-bit inputs

SDI and Fiber

The FS1-X has two standard SDI video inputs and outputs, and two optional Fiber video inputs and outputs.

All SDI video inputs and outputs, including Fiber, are YCbCr 4:2:2 pixel format.

**SD-SDI, 270Mb
(SMPTE 259-C)**

- 525i/59.94
- 625i/50

**HD-SDI, 1.4835 Gb
(SMPTE 292)**

- 720p/59.94
- 1080i/59.94
- 1080PsF/23.98, 1080PsF/29.97
- 1080p/23.98, 1080p/29.97
- 2Kx1080p/23.98, 2Kx1080p/29.97

**HD-SDI, 1.485 Gb
(SMPTE 292)**

- 720p/50
- 1080PsF/24, 1080PsF/25
- 1080p/24, 1080p/25
- 2Kx1080p/24, 2Kx1080p/25

**Dual-link HD-SDI, 2x
1.4835Gb (SMPTE 372)**

- 1080p/59.94
- 2Kx1080p/59.94

**Dual-link HD-SDI, 2x
1.485Gb (SMPTE 372)**

- 1080p/50
- 2Kx1080p/50

**3G-SDI Level A 2.967 (2.97/
1.001) Gb (SMPTE 425-A)**

- 1080p/59.94 (SMPTE 274)
- 2Kx1080p/59.94

**3G-SDI Level A 2.97 Gb
(SMPTE 425-A)**

- 1080p/50 (SMPTE 274)
- 2Kx1080p/50

**3G-SDI Level B 2.967 (2.97/
1.001) Gb (SMPTE 425-B /
SMPTE 372)**

- 1080p/59.94 (SMPTE 274)
- 2Kx1080p/59.94

**2.97 Gb 3G-SDI Level B
(SMPTE 425-B / SMPTE 372)**

- 1080p/50 (SMPTE 274)
- 2Kx1080p/50

HDMI

The HDMI input only accepts SMPTE video formats, and accepts embedded audio. Video input formats are RGB or YCbCr 4:2:2 pixel format for consumer video scan formats. Computer scan rates are not supported.

- 525i/59.94, 525p/59.94
- 625i/50, 625p/50
- 720p/50/59.94
- 1080i/50/59.94
- 1080p/23.98/24/25/29.97/50/59.94

Component HD/SD Analog

The Component Analog Input accepts YCbCr 4:2:2 pixel format, configurable to SMPTE or Betacam levels. If the composite input is used, the component input is not available.

- 525i/59.94
- 625i/50
- 720p/50/59.94
- 1080i/59.94
- 1080PsF/23.98/24/25/29.97
- 1080p/23.98/24/25/29.97

Composite SD Analog

The FS1-X composite analog video input/output formats are listed below. If the component inputs are used, the composite input is not available.

- 525i/59.94 (switchable to NTSC 7.5 IRE or 0 IRE setup)
- 625i/50

Reference

- 525i/59.94, 625i/50 analog composite
- 720p/50/59.94 tri-level sync
- 1080i/50/59.94 tri-level sync
- 1080p50 tri-level sync
- Genlock available to the current Video Processor 1 Input
- Free run

Video Format Conversion

Standard FS1-X Conversions The standard FS1-X can convert almost any input format to nearly any output format, as long as the frame rates are of the same frame rate family. The three families are:

- 59.94/29.97/23.98
- 50/25
- 24

FRC FS1-X Enabled Conversion When the factory installed Frame Rate Converter (FRC) option is present and active, conversions between different frame rate families are supported. An appropriate genlock reference format will be required.

Table 7. Supported Conversions, FRC Enabled

Input Format	Output Format	Genlock Formats supported
1080i50	1080PsF2398 1080p2398 2K1080p2398	525i5994 720p5994 1080i5994 1080p2398 1080PsF2398
1080i5994		
1080p24		
1080p50		
1080p5994		
1080PsF24		
1080p25		
1080p2997		
1080PsF25		
1080PsF2997		
525i5994		
625i50		
720p50		
720p5994		
1080i50		
1080i5994		
1080p2398		
1080p50		
1080p5994		
1080PsF2398		
1080p25		
1080p2997		
1080PsF25		
1080PsF2997		
525i5994		
625i50		
720p50		
720p5994		

Table 7. Supported Conversions, FRC Enabled (continued)

1080i5994	1080PsF25 1080p25 2K1080p25	625i50 720p50 1080i50
1080p2398		
1080p24		
1080p2997		
1080p5994		
1080PsF2398		
1080PsF24		
1080PsF2997		
525i5994		
720p5994		
1080i50	1080PsF2997 1080p2997 2K1080p2997	525i5994 720p5994 1080i5994
1080p2398		
1080p24		
1080p25		
1080p50		
1080PsF2398		
1080PsF24		
1080PsF25		
625i50		
720p50		
1080i50	525i5994 720p5994 1080i5994 1080p5994, 2K1080p5994	525i5994 720p5994 1080i5994
1080p2398		
1080p24		
1080p50		
1080p25		
1080p2997		
1080PsF25		
1080PsF2997		
1080PsF2398		
1080PsF24		
625i50		
720p50		

Table 7. Supported Conversions, FRC Enabled (continued)

1080i5994		
1080p2398		
1080p24		
1080p25		
1080p2997	625i50	
1080PsF25	720p50	625i50
1080PsF2997	1080i50	720p50
1080p5994	1080p50	1080i50
	2K1080P50	
1080PsF2398		
1080PsF24		
525i5994		
720p5994		

Video Format Alarms When incompatible I/O formats are detected, an alarm can be triggered with these results:

- Lights the relevant alarm LED on the front panel (FMT ERROR, 1 or 2).
- Displays an alarm in the browser user interface.
- Influences selection of the first-displayed status screen.
- Generates an SNMP trap (if configured).
- Triggers a GPI Output (if configured).

Video A/D, D/A Converters

- 12 bits
- 2x oversampled (HD)
- 4x oversampled (SD)

Audio

Inputs and Outputs The FS1-X can accept and route any audio inputs to any audio output.

- 8-channel balanced analog I/O, DB-25F 25-pin connector (Tascam pinout)
- 16-channel AES/EBU I/O (BNC), DB-25F 25-pin connector
- 16-channel SDI/HD-SDI embedded BNC (2)
- 16-channel SDI/HD-SDI embedded Fiber (2)
- 64-channels MADI digital audio. BNC
- 64-channels MADI digital audio. Fiber

Analog Audio Levels Analog audio input and output levels, as referenced to full scale digital, can be set to:

- +12dBu (consumer), +15dBu, +18dBu, +24dBu (professional)

Audio Adjustments Individual audio channels (or channel pairs) can adjusted for:

- Level: +/- 18 db
- Phase: Normal or Reverse

- Delay: -768 to +12288 samples (-2.7 ms to +256 ms)

Interfaces

- LAN**
 - 10/100/1000 automatic configuration
 - Automatic cable crossover (auto MDI-X)
 - Embedded web server
 - SNMP
- GPI**
 - DB-15F: single connector provides four inputs and four outputs. See Appendix B for a connector pinout and GPI specifications.

Physical

- Dimensions**
 - Width: 17.5 inches (44.45cm); 19 inches (48.26 cm) including rack ears
 - Depth: 16 inches (40.65 cm), including knobs and connectors that extend beyond the frame
 - Height: 1RU, 1.75 inches (4.44cm)
- Weight**
 - 7.85 pounds, 3.56 kilograms
- Temperature**
 - Operating temperature range: 0–40 degrees C
 - Cooled via two internal fans and side vents.
- Power**
 - Voltage: 100-240 VAC
 - Power Consumption: 55 Watts, 60 Watts with FRC option (70 Watts maximum)
 - Two independent power supplies, fully redundant, diode isolated.

Appendix B: FS1-X Pinouts

GPI Pinouts

Figure 17. GPI DE-15F Connector Pinout

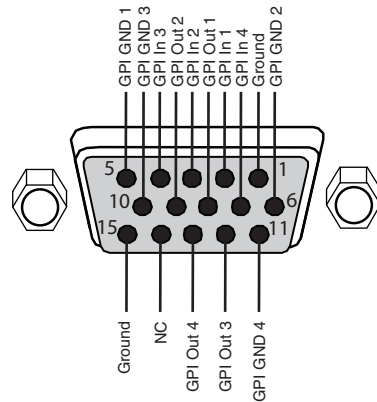

Pin	Function	Pin	Function
1	Ground	9	GPI Out 2
2	GPI In 1	10	GPI GND 3
3	GPI In 2	11	GPI GND 4
4	GPI In 3	12	GPI Out 3
5	GPI GND 1	13	GPI Out 4
6	GPI GND 2	14	NC
7	GPI In 4	15	Ground
8	GPI Out 1		

The GPI inputs and outputs are electrically isolated from power and ground on the FS1-X frame. There are four inputs and four outputs. Electrical isolation is provided for up to four pieces of external equipment.

The following guidelines apply to the four GPI inputs and outputs:

- GPI In 1 and GPI Out 1 share a common isolated ground on pin 5 (GPI GND 1),
- GPI In 2 and GPI Out 2 share a common isolated ground on pin 6(GPI GND 2).
- GPI In 3 and GPI Out 3 share a common isolated ground on pin 10(GPI GND 3).
- GPI In 4 and GPI Out 4 share a common isolated ground on pin 11 (GPI GND 4).
- Pins 1 and 15, local chassis ground, may only be used as references when isolation is not required.
- All four GPI inputs are internally pulled high through a 10K ohm resistor to an isolated +5V supply, so that a relay contact closure or any device sinking at least 0.4 mA to ground will register a logic low.
- All four GPI outputs are +5V TTL compatible, sourcing up to 6mA and sinking up to 4mA each.
- GPI Inputs light the front panel EXT LED when triggered.

The following illustration shows typical external wiring to the GPI connector. The GPI inputs require some kind of contact closure between the input pin and the input ground pin to register the logic low that triggers the GPI input.

You can connect the outputs to TTL buffers that communicate the GPI output logic levels to other devices. For example, you could use an opto-isolator controlling a relay to activate other equipment as shown below.

Figure 18. Typical GPI Input and Output Connections

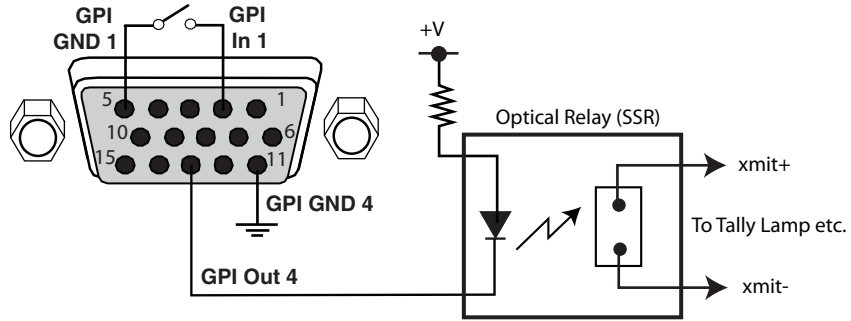

Audio Connection Pinouts

Analog Audio

Figure 19. Analog Audio Connector Pinout

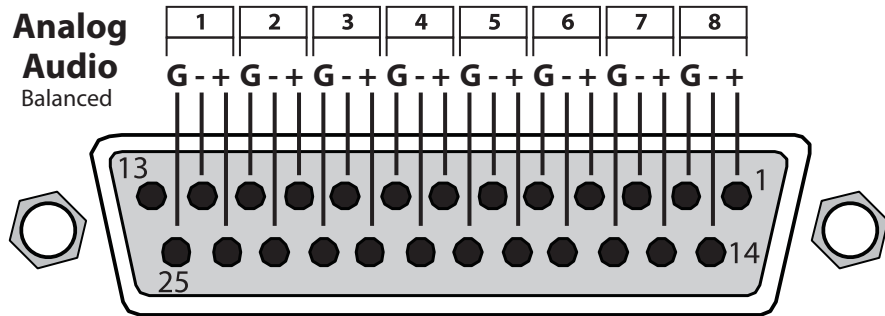

G = Ground -/+ = Balanced Pair

The two DB25 connectors on the FS1-X rear panel support a TASCAM-style cable snake for balanced 8-channel analog audio. The pinout is the same for both input and output connectors, each following the TASCAM DB-25 standard shown in the drawing above. The top connector is for analog audio inputs 1-8, and the bottom connector is for analog audio outputs 1-8

Digital Audio

Figure 20. Digital Audio Connector Pinout

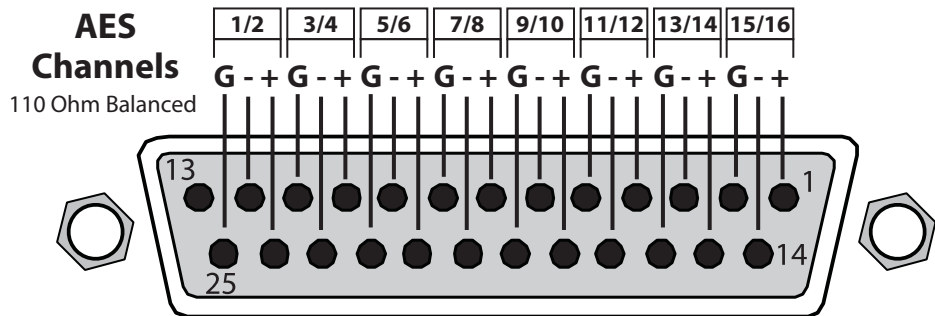

G = Ground

To MUX into unbalanced AES BNC connections, use Balun 75 ohm adapter.

The same pinout scheme as above is used for the AES/EBU digital audio connections, except each channel handles a pair of digital audio signals (16 total per connector). The top connector is for digital audio input channels 1-16, and the bottom connector is for digital audio output channels 1-16.

Appendix C: Safety & Compliance

Federal Communications Commission (FCC) Compliance Notices

Class A Interference Statement

This equipment has been tested and found to comply with the limits for a Class A digital device, pursuant to Part 15, Subpart B of the FCC Rules. These limits are designed to provide reasonable protection against harmful interference in a residential installation. This equipment generates, uses, and can radiate radio frequency energy and, if not installed and used in accordance with the instructions, may cause harmful interference to radio communications. However, there is no guarantee that interference will not occur in a particular installation. If this equipment does cause harmful interference to radio or television reception, which can be determined by turning the equipment off and on, the user is encouraged to try to correct the interference by one or more of the following measures:

- Reorient or relocate the receiving antenna.
- Increase the separation between the equipment and receiver.
- Connect the equipment into an outlet on a circuit different from that to which the receiver is connected.
- Consult the dealer or an experienced radio/TV technician for help.

FCC Caution

This device complies with Part 15 of the FCC Rules. Operation is subject to the following two conditions: (1) This device may not cause harmful interference, and (2) this device must accept any interference received, including interference that may cause undesired operation.

Canadian ICES Statement

Canadian Department of Communications Radio Interference Regulations

This digital apparatus does not exceed the Class A limits for radio-noise emissions from a digital apparatus as set out in the Radio Interference Regulations of the Canadian Department of Communications. This Class A digital apparatus complies with Canadian ICES-003.

Règlement sur le brouillage radioélectrique du ministère des Communications

Cet appareil numérique respecte les limites de bruits radioélectriques visant les appareils numériques de classe A prescrites dans le Règlement sur le brouillage radioélectrique du ministère des Communications du Canada. Cet appareil numérique de la Classe A est conforme à la norme NMB-003 du Canada.

European Union and European Free Trade Association (EFTA) Regulatory Compliance

This equipment may be operated in the countries that comprise the member countries of the European Union and the European Free Trade Association. These countries, listed in the following paragraph, are referred to as The European Community throughout this document:

AUSTRIA, BELGIUM, BULGARIA, CYPRUS, CZECH REPUBLIC, DENMARK, ESTONIA, FINLAND, FRANCE, GERMANY, GREECE, HUNGARY, IRELAND, ITALY, LATVIA, LITHUANIA, LUXEMBOURG, MALTA, NETHERLANDS, POLAND, PORTUGAL, ROMANIA, SLOVAKIA, SLOVENIA, SPAIN, SWEDEN, UNITED KINGDOM, ICELAND, LICHTENSTEIN, NORWAY, SWITZERLAND

Declaration of Conformity

Marking by this symbol indicates compliance with the Essential Requirements of the EMC Directive of the European Union 2004/108/EC.



This equipment meets the following conformance standards:

Safety:

- EN 62368-1: 2014 + A11 (T-Mark License),
- IEC 62368-1: 2014 (CB Scheme Report/Certificates)
- Additional licenses issued for specific countries available on request.

Emissions:

- EN 55032: 2015 + A11: 2020, CISPR 32: 2015,
- EN 61000-3-2: 2014, EN 61000-3-3: 2013

Immunity:

- EN 55035: 2017 + A11: 2020, EN 61000-4-2:2009, EN 61000-4-3:2006+A1:2008 +A2:2010,
- EN 61000-4-4: 2012, EN 61000-4-5: 2014 +A1: 2017, EN 61000-4-6: 2014,
- EN 61000-4-11: 2020

Environments: E2, E3 and E

The product is also licensed for additional country specific standards as required for the International Marketplace.



Warning!

This is a Class A product. In a domestic environment, this product may cause radio interference, in which case, the user may be required to take appropriate measures.

Achtung! Dieses ist ein Gerät der Funkstörgrenzwertklasse A. In Wohnbereichen können bei Betrieb dieses Gerätes Rundfunkstörungen auftreten, in welchen Fällen der Benutzer für entsprechende Gegenmaßnahmen verantwortlich ist.

Attention! Ceci est un produit de Classe A. Dans un environnement domestique, ce produit risque de créer des interférences radioélectriques, il appartiendra alors à l'utilisateur de prendre les mesures spécifiques appropriées.

Korean KCC Compliance Statement

사 용 자 안 내 문
이 기기는 업무용 환경에서 사용할 목적으로 적합성평가를 받은 기기로서 가정용 환경에서 사용하는 경우 전파간섭의 우려가 있습니다.

Taiwan Compliance Statement

警告使用者：
這是甲類的資訊產品，在居住的環境中使用時，可能會造成射頻干擾，在這種情況下，使用者會被要求採取某些適當的對策。

This is a Class A product based on the standard of the Bureau of Standards, Metrology and Inspection (BSMI) CNS 13438, Class A. In a domestic environment this product may cause radio interference in which case the user may be required to take adequate measures.

Japanese Compliance Statement

この装置は、クラスA情報技術装置です。この装置を家庭環境で使用すると電波妨害を引き起こすことがあります。この場合には使用者が適切な対策を講ずるよう要求されることがあります。 VCCI-A

This is a Class A product based on the standard of the VCCI Council (VCCI 32: 2016). If this equipment is used in a domestic environment, radio interference may occur, in which case, the user may be required to take corrective actions.

Chinese Compliance Statement

This product has been tested to the following Chinese standards:
GB 17625.1-2012; GB/T 13837-2012; GB 8898-2011
This is to certify that the above mentioned product(s) complies with the requirements of certification rules of CQC12-045800-2022 under certificate number CQC2014010805719722.

Recycling Notice



This symbol on the product or its packaging indicates that this product must not be disposed of with your other household waste. Instead, it is your responsibility to dispose of your waste equipment by handing it over to a designated collection point for the recycling of waste electrical and electronic equipment. The separate collection and recycling of your waste equipment at the time of disposal will help conserve natural resources and ensure that it is recycled in a manner that protects human health and the environment. For more information about where you can drop off your waste for recycling, please contact your local authority, or where you purchased your product.

Translated Warning and Caution Messages

The following caution statements, warning conventions, and warning messages apply to this product and manual.



Warning Symbol





Hazard Warning



Caution Symbol

Before Operation Please Read These Instructions

	<p>Warning! Read and follow all warning notices and instructions marked on the product or included in the documentation.</p> <p>Avertissement ! Lisez et conformez-vous à tous les avis et instructions d'avertissement indiqués sur le produit ou dans la documentation.</p> <p>Warnung! Lesen und befolgen Sie die Warnhinweise und Anweisungen, die auf dem Produkt angebracht oder in der Dokumentation enthalten sind.</p> <p>¡Advertencia! Lea y siga todas las instrucciones y advertencias marcadas en el producto o incluidas en la documentación.</p> <p>Aviso! Leia e siga todos os avisos e instruções assinalados no produto ou incluídos na documentação.</p> <p>Avviso! Leggere e seguire tutti gli avvisi e le istruzioni presenti sul prodotto o inclusi nella documentazione.</p>
	<p>Warning! Do not use this device near water and clean only with a dry cloth.</p> <p>Avertissement! N'utilisez pas cet appareil près de l'eau et nettoyez-le seulement avec un tissu sec..</p> <p>Warnung! Das Gerät nicht in der Nähe von Wasser verwenden und nur mit einem trockenen Tuch säubern.</p> <p>¡Advertencia! No utilice este dispositivo cerca del agua y límpielo solamente con un paño seco.</p> <p>Aviso! Não utilize este dispositivo perto da água e limpe-o somente com um pano seco.</p> <p>Avviso! Non utilizzare questo dispositivo vicino all'acqua e pulirlo soltanto con un panno asciutto.</p>
	<p>Warning! Do not block any ventilation openings. Install in accordance with the manufacturer's instructions.</p> <p>Avertissement ! Ne bloquez aucune ouverture de ventilation. Suivez les instructions du fabricant lors de l'installation.</p> <p>Warnung! Die Lüftungsöffnungen dürfen nicht blockiert werden. Nur gemäß den Anweisungen des Herstellers installieren.</p> <p>¡Advertencia! No bloquee ninguna de las aberturas de la ventilación. Instale de acuerdo con las instrucciones del fabricante.</p> <p>Aviso! Não obstrua nenhuma das aberturas de ventilação. Instale de acordo com as instruções do fabricante.</p> <p>Avviso! Non ostruire le aperture di ventilazione. Installare in conformità con le istruzioni del fornitore.</p>

**Warning!**

Do not install near any heat sources such as radiators, heat registers, stoves, or other apparatus (including amplifiers) that produce heat.

Avertissement ! N'installez pas l'appareil près d'une source de chaleur telle que des radiateurs, des bouches d'air de chauffage, des fourneaux ou d'autres appareils (amplificateurs compris) qui produisent de la chaleur.

Warnung! Nicht in der Nähe von Wärmequellen wie Heizkörpern, Heizregistern, Öfen oder anderen Wärme erzeugenden Geräten (einschließlich Verstärkern) aufstellen.

¡Advertencia! No instale cerca de fuentes de calor tales como radiadores, registros de calor, estufas u otros aparatos (incluidos amplificadores) que generan calor.

Aviso! Não instale perto de nenhuma fonte de calor tal como radiadores, saídas de calor, fogões ou outros aparelhos (incluindo amplificadores) que produzam calor.

Avviso! Non installare vicino a fonti di calore come termosifoni, diffusori di aria calda, stufe o altri apparecchi (amplificatori compresi) che emettono calore.

**Warning!**

Refer all servicing to qualified service personnel. Servicing is required when the device has been damaged in any way, such as power-supply cord or plug is damaged, liquid has been spilled or objects have fallen into the device, the device has been exposed to rain or moisture, does not operate normally, or has been dropped.



Avertissement ! Référéz-vous au personnel de service qualifié pour tout entretien. L'entretien est exigé quand l'appareil a été endommagé de quelque manière que ce soit, par exemple lorsque le cordon d'alimentation ou la prise sont endommagés, que du liquide a été versé ou des objets sont tombés dans l'appareil, que l'appareil a été exposé à la pluie ou à l'humidité, ne fonctionne pas normalement ou est tombé.

Warnung! Das Gerät sollte nur von qualifizierten Fachkräften gewartet werden. Eine Wartung ist fällig, wenn das Gerät in irgendeiner Weise beschädigt wurde, wie bei beschädigtem Netzkabel oder Netzstecker, falls Flüssigkeiten oder Objekte in das Gerät gelangen, das Gerät Regen oder Feuchtigkeit ausgesetzt wurde, nicht ordnungsgemäß funktioniert oder fallen gelassen wurde.

¡Advertencia! Consulte al personal calificado por cuestiones de reparación. El servicio de reparación se requiere cuando el dispositivo ha recibido cualquier tipo de daño, por ejemplo cable o espigas dañadas, se ha derramado líquido o se han caído objetos dentro del dispositivo, el dispositivo ha sido expuesto a la lluvia o humedad, o no funciona de modo normal, o se ha caído.

Aviso! Remeta todos os serviços de manutenção para o pessoal de assistência qualificado. A prestação de serviços de manutenção é exigida quando o dispositivo foi danificado mediante qualquer forma, como um cabo de alimentação ou ficha que se encontra danificado/a, quando foi derramado líquido ou caíram objectos sobre o dispositivo, quando o dispositivo foi exposto à chuva ou à humidade, quando não funciona normalmente ou quando foi deixado cair.

Avviso! Fare riferimento al personale qualificato per tutti gli interventi di assistenza. L'assistenza è necessaria quando il dispositivo è stato danneggiato in qualche modo, ad esempio se il cavo di alimentazione o la spina sono danneggiati, è stato rovesciato del liquido è stato rovesciato o qualche oggetto è caduto nel dispositivo, il dispositivo è stato esposto a pioggia o umidità, non funziona correttamente o è caduto.

	<p>Warning! Disconnect the external AC power supply line cord(s) from the mains power before moving the unit.</p> <p>Avertissement! Retirez le ou les cordons d'alimentation en CA de la source d'alimentation principale lorsque vous déplacez l'appareil.</p> <p>Warnung! Trennen Sie die Wechselstrom-Versorgungskabel vom Netzstrom, bevor Sie das Gerät verschieben.</p> <p>¡Advertencia! Cuando mueva la unidad desenchufe de la red eléctrica el/los cable(s) de la fuente de alimentación CA tipo brick.</p> <p>Advertência! Remova os cabos CA de alimentação brick da rede elétrica ao mover a unidade.</p> <p>Avvertenza! Scollegare il cavo dell'alimentatore quando si sposta l'unità.</p>
	<p>Hazard Warning! High Voltage. This situation or condition can cause injury due to electric shock.</p> <p>Avertissement! Tension élevée. Cette situation ou condition peut causer des blessures dues à un choc électrique.</p> <p>Warnung! Hochspannung. Diese Situation oder Bedingung kann zu Verletzungen durch Stromschlag führen.</p> <p>¡Advertencia! Alto voltaje . Esta situación o condición puede causar lesiones debidas a una descarga eléctrica.</p> <p>Aviso! Alta Tensão . Esta situação ou condição pode causar danos devido a choques elétricos.</p> <p>Avviso! Alta tensione. Questa situazione o condizione può causare lesioni a causa di scosse elettriche.</p>
	<p>Warning! Only use attachments and accessories specified and/or sold by the manufacturer.</p> <p>Avertissement! Utilisez seulement les attaches et accessoires spécifiés et/ou vendus par le fabricant.</p> <p>Warnung! Verwenden Sie nur Zusatzgeräte und Zubehör angegeben und / oder verkauft wurde durch den Hersteller.</p> <p>¡Advertencia! Utilice solamente los accesorios y conexiones especificados y/o vendidos por el fabricante.</p> <p>Aviso! Utilize apenas equipamentos/acessórios especificados e/ou vendidos pelo fabricante.</p> <p>Avviso! Utilizzare soltanto i collegamenti e gli accessori specificati e/o venduti dal produttore.</p>

**Warning!**

Do not defeat the safety purpose of the polarized or grounding-type plug. A polarized plug has two blades with one wider than the other. A grounding type plug has two blades and a third grounding prong. The wide blade or the third prong are provided for your safety. If the provided plug does not fit into your outlet, consult an electrician for replacement of the obsolete outlet.

Avvertissement! La sécurité de la prise polarisée ou de la prise de type mise à la terre ne doit en aucun cas être empêchée de fonctionner. Une prise polarisée a deux broches, l'une étant plus large que l'autre. Une prise de type mise à la terre a deux broches et une troisième broche pour la mise à la terre. La broche large ou la troisième broche sont fournies pour votre sécurité. Si la prise fournie ne s'insère pas dans votre prise femelle, consultez un électricien pour le remplacement de la prise femelle obsolète.

Warnung! Der Sicherheitszweck des gepolten bzw. Schukosteckers ist zu berücksichtigen. Ein gepolter Stecker verfügt über zwei Pole, von denen einer breiter als der andere ist. Ein Schukostecker verfügt neben den zwei Polen noch über einen dritten Pol zur Erdung. Der breite Pol bzw. der Erdungspol dienen der Sicherheit. Wenn der zur Verfügung gestellte Stecker nicht in Ihren Anschluss passt, konsultieren Sie einen Elektriker, um den veralteten Anschluss zu ersetzen.

¡Advertencia! No eche por tierra la finalidad del tipo de enchufe polarizado con conexión a tierra. Un enchufe polarizado tiene dos espigas, una más ancha que la otra. Un enchufe con conexión a tierra tiene dos espigas iguales y una tercera espiga que sirve para la conexión a tierra. La espiga ancha, o la tercera espiga, sirven para su seguridad. Si el enchufe suministrado no encaja en el tomacorriente, consulte con un electricista para reemplazar el tomacorriente obsoleto.

Aviso! Não anule a finalidade da segurança da ficha polarizada ou do tipo ligação terra. Uma ficha polarizada tem duas lâminas sendo uma mais larga do que a outra. Uma ficha do tipo de ligação à terra tem duas lâminas e um terceiro terminal de ligação à terra. A lâmina larga ou o terceiro terminal são fornecidos para sua segurança. Se a ficha fornecida não couber na sua tomada, consulte um electricista para a substituição da tomada obsoleta.

Avviso! Non compromettere la sicurezza della spina polarizzata o con messa a terra. Una spina polarizzata ha due spinotti, di cui uno più largo. Una spina con messa a terra ha due spinotti e un terzo polo per la messa a terra. Lo spinotto largo o il terzo polo sono forniti per motivi di sicurezza. Se la spina fornita non si inserisce nella presa di corrente, contattare un elettricista per la sostituzione della presa obsoleta.

**Warning!**

Since the Mains plug is used as the disconnection for the device, it must remain readily accessible and operable.

Avertissement! Puisque la prise principale est utilisée pour débrancher l'appareil, elle doit rester aisément accessible et fonctionnelle.

Warnung! Da der Netzstecker als Trennvorrichtung dient, muss er stets zugänglich und funktionsfähig sein.

¡Advertencia! Puesto que el enchufe de la red eléctrica se utiliza como dispositivo de desconexión, debe seguir siendo fácilmente accesible y operable.

Aviso! Dado que a ficha principal é utilizada como a desconexão para o dispositivo, esta deve manter-se prontamente acessível e funcional.

Avviso! Poiché il cavo di alimentazione viene usato come dispositivo di sconnessione, deve rimanere prontamente accessibile e operabile.

**Warning!**

Protect the power cord from being walked on or pinched particularly at plugs, convenience receptacles, and the point where they exit from the device.

Avertissement! Protégez le cordon d'alimentation pour que l'on ne marche pas dessus ou qu'on le pince, en particulier au niveau des prises mâles, des réceptacles de convenance, et à l'endroit où il sort de l'appareil.

Warnung! Vermeiden Sie, dass auf das Netzkabel getreten oder das Kabel geknickt wird, insbesondere an den Steckern, den Steckdosen und am Kabelausgang am Gerät.

¡Advertencia! Proteja el cable de energía para que no se le pise ni apriete, en especial cerca del enchufe, los receptáculos de conveniencia y el punto del que salen del equipo.

Aviso! Proteja o cabo de alimentação de ser pisado ou de ser comprimido particularmente nas fichas, em tomadas de parede de conveniência e no ponto de onde sai do dispositivo.

Avviso! Proteggere il cavo di alimentazione in modo che nessuno ci cammini sopra e che non venga schiacciato soprattutto in corrispondenza delle spine e del punto in cui esce dal dispositivo.

**Warning!**

Unplug this device during lightning storms or when unused for long periods of time.

Avertissement! Débranchez cet appareil pendant les orages avec éclaircies s'il est inutilisé pendant de longues périodes.

Warnung! Das Gerät ist bei Gewitterstürmen oder wenn es über lange Zeiträume ungenutzt bleibt vom Netz zu trennen.

¡Advertencia! Desenchufe este dispositivo durante tormentas eléctricas o cuando no se lo utilice por largos periodos del tiempo.

Aviso! Desconecte este dispositivo da tomada durante trovoadas ou quando não é utilizado durante longos períodos de tempo.

Avviso! Utilizzare soltanto i collegamenti e gli accessori specificati e/o venduti dal produttore, quali il treppiedi e l'esoscheletro.

**Warning!**

Do not open the chassis. There are no user-serviceable parts inside. Opening the chassis will void the warranty unless performed by an AJA service center or licensed facility.

Avertissement! Ne pas ouvrir le châssis. Aucun élément à l'intérieur du châssis ne peut être réparé par l'utilisateur. La garantie sera annulée si le châssis est ouvert par toute autre personne qu'un technicien d'un centre de service ou d'un établissement agréé AJA.

Warnung! Öffnen Sie das Gehäuse nicht. Keine der Geräteteile können vom Benutzer gewartet werden. Durch das Öffnen des Gehäuses wird die Garantie hinfällig, es sei denn, solche Wartungsarbeiten werden in einem AJA-Service-Center oder einem lizenzierten Betrieb vorgenommen.

¡Advertencia! No abra el chasis. El interior no contiene piezas reparables por el usuario. El abrir el chasis anulará la garantía a menos que se lo haga en un centro de servicio AJA o en un local autorizado.

Advertência! Não abra o chassi. Não há internamente nenhuma peça que permita manutenção pelo usuário. Abrir o chassi anula a garantia, a menos que a abertura seja realizada por uma central de serviços da AJA ou por um local autorizado.

Avvertenza! Non aprire lo chassis. All'interno non ci sono parti riparabili dall'utente. L'apertura dello chassis invaliderà la garanzia se non viene effettuata da un centro ufficiale o autorizzato AJA.

**Warning!**

To meet safety regulations for leakage current, connect the dual power supplies to separate branch circuits.

¡Advertencia! Para cumplir con las normas de seguridad para la corriente de fuga, conecte las dos fuentes de alimentación para circuitos derivados diferentes.

Attention! Pour répondre aux mesures de sécurité concernant le courant de fuite, raccorder les sources d'alimentation doubles à des circuits de dérivation distincts.

Warnung! Zur Erfüllung der Sicherheitsbestimmungen bezüglich Reststrom schließen Sie bitte die zwei Netzteile an unterschiedlichen Abzweigungen an.

Cuidado! Para atender aos regulamentos de segurança para correntes de fuga, conecte as fontes duplas a circuitos elétricos separados.

Attenzione! Per soddisfare le norme di sicurezza sulla corrente di perdita, collegare i doppi alimentatori a circuiti derivati separati.

Warranty Information

Limited Warranty on Hardware

AJA Video Systems, Inc. (AJA Video) warrants that the hardware product, not including software components, will be free from defects in materials and workmanship for a period of five years from the date of purchase. AJA Video provides a separate software warranty as part of the license agreement applicable to software components.

If the Customer brings a valid claim under this limited warranty for a hardware product (hereafter, a “product”) during the applicable warranty period, AJA Video will, at its sole option and as the Customer’s sole remedy for breach of the above warranty, provide one of the following remedies:

- Repair or facilitate the repair the product within a reasonable period of time, free of charge for parts and labor.
- Replace the product with a direct replacement or with a product that performs substantially the same function as the original product.
- Issue a refund of the original purchase price less depreciation to be determined based on the age of the product at the time remedy is sought under this limited warranty.

To obtain service under this warranty, the Customer must notify AJA Video of the defect before expiration of the warranty period and make suitable arrangements for the performance of service by contacting AJA Video support through the channels set forth on the support contacts web page at <https://www.aja.com/support>. Except as stated, the Customer shall bear all shipping, packing, insurance and other costs, excluding parts and labor, to effectuate repair. Customer shall pack and ship the defective product to a service center designated by AJA Video, with shipping charges prepaid. AJA Video shall pay to return the product to Customer, but only if to a location within the country in which the AJA Video service center is located. SOME JURISDICTIONS DO NOT ALLOW THE EXCLUSION OF IMPLIED WARRANTIES OR LIMITATIONS ON APPLICABLE STATUTORY RIGHTS OF A CONSUMER, SO SOME OR ALL OF THE TERMS OF THIS PARAGRAPH MAY NOT APPLY TO YOU.

Limitations of Liability

Under no circumstances shall AJA video BE LIABLE IN ANY WAY FOR ANY LOST, CORRUPTED OR DESTROYED DATA, FOOTAGE OR WORK, OR FOR ANY OTHER INDIRECT, SPECIAL, INCIDENTAL OR CONSEQUENTIAL DAMAGES OR LOST PROFITS, OR FOR ANY THIRD PARTY CLAIM, IN CONNECTION WITH THE PRODUCT, WHETHER RESULTING FROM DEFECTS IN THE PRODUCT, SOFTWARE OR HARDWARE FAILURE, OR ANY OTHER CAUSE WHATSOEVER, EVEN IF AJA VIDEO HAS BEEN ADVISED OF THE POSSIBILITY OF SUCH DAMAGES. AJA VIDEO’S LIABILITY IN CONNECTION WITH THE PRODUCT SHALL UNDER NO CIRCUMSTANCES EXCEED THE PURCHASE PRICE PAID FOR THE PRODUCT. The foregoing limitations apply even if any remedy set forth in this LIMITED WARRANTY fails of its essential purpose. SOME JURISDICTIONS DO NOT ALLOW THE LIMITATION OF LIABILITY FOR PERSONAL INJURY, OR OF INCIDENTAL OR CONSEQUENTIAL DAMAGES, SO SOME OR ALL OF THE TERMS OF THIS PARAGRAPH MAY NOT APPLY TO YOU.

Governing Law and Language; Your Rights

This limited warranty is the only warranty provided by AJA Video on the hardware product. It supersedes all prior or contemporaneous understandings regarding such subject matter. No amendment to or modification of this warranty will be binding unless in writing and signed by AJA Video. The laws of the State of California, USA will govern this warranty and any dispute arising from it. Any translation of this Agreement is intended for convenience and to meet local requirements and in the event of a dispute between the English and any non-English versions, the English version of this warranty will govern. This limited warranty gives you specific legal rights and you may have other rights that vary from jurisdiction to jurisdiction, some of which are noted above.

Index

Numerics

- 1 Channel Operating Mode *16*
- 10/100/1000 Base-TX Ethernet Connector *30*
- 10/100/1000 LAN Connector *25*
- 100x Speed
 - Coarse Adjust *19, 22*
- 10x Speed
 - Coarse Adjust *19, 22*
- 2 Channel Operating Mode *16*
- 2:3:3:2 Pulldown *80*
- 3:2 Pulldown *80*
- 3G Video
 - Fiber1 3G Detect Menu *61*
 - Fiber2 Input Protect Menu *61*
 - SDI1 3G Detect Menu *59*
 - SDI2 Input Protect Menu *60*
- 75-Ohm Terminator *26*

A

- AC Power
 - Connection *27*
 - Specifications *117*
 - Voltage *29*
 - Warnings *29*
- Address, IP *47*
- Adjust and Select Knobs *21*
- AES/EBU Audio
 - AES/EBU SRC Mode *63*
 - AES/EBU SRCs *63*
- AES/EBU Digital Audio Connectors *24*
- AFD
 - AFD Out Menu *77*
 - AFD VANC Output Lines Menu *77*
- AJA Technical Support *92*
- ALARM LED *23*
- Alarms
 - Power Supply *56*
 - Reference *57*
 - Vid1 Format *56*
 - Vid2 Format *56*
 - Video Format *116*
 - Video Incompatibility *23*
- Alarms Configuration browser screen *96*
- Alphanumeric Display *18*
- Analog Audio
 - Analog Audio Std Menu *59*
- Analog Audio Connectors *25*
- Analog Audio Pinouts *119*
- Analog In Format Menu *59*

- Analog Video *59*
- Applications, Typical *12*
- Audio
 - Audio Proc 1 and Audio Proc 2 Menu Groups *105*
 - Connections (pinout) *119*
 - Features *12*
 - Global Output Menu *90*
 - Inputs and Outputs, Specifications *116*
 - Level Choices *36*
 - Phantom Power *36*
 - Reset Mapped Output Menu *90*
- Audio and Video Routing
 - Using Presets *58*
- Audio Connectors
 - Analog *25*
 - Digital *24*
- Audio Output
 - Audio Output Menu Group *21*
 - Video Output Button *21*
- Audio Output browser screen *106*
- Audio Proc
 - Audio Proc Button *21*
 - Audio Proc Menu Group *21*
- Audio Proc browser screen *105*
- Audio Processor
 - Technical Description *15*
- Audio Processor Block Diagram *14*
- Authentication *51*

B

- Background Fill Menu *67*
- Block Diagram
 - System *14*
- Browser
 - Connecting to *91*
 - Supported *91*
- Browser Control *34, 91*
 - Multiple FS1-Xs *92*
 - via Ethernet *13*
- Browser Screens
 - Alarms Configuration *96*
 - Audio Output *106*
 - Audio Proc *105*
 - Config *99*
 - Firmware *108*
 - General Description *91*
 - Network *94, 98*
 - Presets *101*

- Remote *107*
- Status *97*
- Video Output *104*
- Video Proc *103*
- Buttons *18, 19*
 - Audio Output *21*
 - Audio Proc *21*
 - Config *20, 54*
 - Menu Group *19*
 - Preset *20, 58*
 - Remote *19, 51*
 - Status *19, 48*
 - System *20*
 - Video Output *21*
 - Video Proc *20, 64*
- Bypass Channel
 - Video Processor *2 16*

C

- Caption Status *50*
- Chassis, Mounting *29*
- Closed Captioning Translator Menu *78*
- Coarse Adjust *19, 22*
 - 100x Speed *19*
 - 10x Speed *19*
- Color Corrector (RGB) *73*
- Color Red Gain *73*
- Compliance Statements *121*
- Component In/Out Connectors *25*
- Component Video
 - Component Out Format Menu *59*
 - Component Out Menu *82*
 - Component Video Input Specifications *113*
- Composite In/Out Connectors *25*
- Composite Video
 - Composite Downconv Crop Menu *62*
- Computer Formats
 - Genlock Source Menu *61*
- Config browser screen *99*
 - Display Intensity *100*
 - Hidden Menus *100*
- Config Button *20*
- Config Menu Group *20, 54*
- Connection Status *92*
- Connectors
 - GPI pinouts *118*
 - Summary Descriptions *24*
- Control
 - Browser *13, 34, 91*
 - Features *12*
 - Front Panel *13*
 - Overview *13*
- SNMP *13*
- Control Buttons, Knobs, and Display *18*
- Conversion
 - Procedure *15*
- Conversion Exceptions *112*
- Cooling Requirements *29*
- Custom
 - Custom Aspect Menu *74*
 - Custom Bottom Crop Menu *74*
 - Custom H Position Menu *74*
 - Custom Left Crop Menu *74*
 - Custom Right Crop Menu *74*
 - Custom Size Menu *74*
 - Custom Size/Pos Menu *73*
 - Custom V Position Menu *74*

D

- Default Gateway
 - Menu *55*
- Depth *29*
- Description, Technical *14*
- Digital Audio Pinouts *119*
- Dimensions, Chassis *29*
- Display
 - Alphanumeric *18*
 - Description *18*
 - Display Intensity *100*
 - Display Intensity Menu *57*
 - Menus *44*
- Downconversion
 - Downconvert AFD Default Menu *78*
 - Downconvert Mode Menu *69*
- Download Software *34*
- Drop Down Parameter Operation
 - Browser Screens *93*
- Dual Stream mode *60*

E

- Embedded Audio Out Menu *88*
- Equipment, Mounting *29*
- Ethernet Connections
 - Supported *91*
- Ethernet Connector *30*
- Ethernet Specifications *117*
- Example
 - Film Cadence *80*
 - HD to Letterbox SD over Video *41*
 - SD to Sidebar HD over Matte *40*
- Export
 - Presets browser screen *102*
- Export All *102*
- Export All Presets
 - Presets browser screen *102*

EXT LED 23

F

Factory Preset

Presets browser screen 101

Factory Preset Menu 58

Factory Settings, Resetting To 93

Fan Speed Setting 57

Features

Audio 12

Control 12

Video 11

Fiber

Fiber I/O Installation 28

Fiber1 1080p50/60 Config Menu 83

Fiber1 Video Out Menu 82

Fiber2 1080p Config Menu 83

Fiber2 Video Out Menu 82

Fiber I/O

Features 14

Film Cadence 80

Film Cadence Removal 80

Conditions 81

Firmware browser screen 108

First Power Up 38

Formats

Component Video Inputs 113

FMT ERR 1/2 LEDs 22

HDMI Input 113

Video 113

Video Inputs 112

Frame Rate Converter

Features 13

Frame Rate Menu 61

Frame, Mounting 29

FRC Active

FRC ACTIVE LED 23

FRC Enable Menu 61

FRC Presence

FRC PRES LED 22

FRC Status 50

Front Panel Control 13

Coarse Adjust 19

Operational Summary 19

Front Panel Description 18

G

Gateway Address

Default 31

Genlock

Genlock Source Menu 61

Genlock Source

Overview 15

Global Output Menu 90

GPI In/Out Connectors 25

GPI Inputs and Outputs 13

GPIs

GPI 1–4 OUT Menu 54

GPI Connections 36

GPI Connections (pinout) 118

GPI I/O Specifications 117

GPI IN 1–4 Response Menu 52

GPI Typical Connections 118

Interactions with Presets 54

H

HD to Letterbox SD over Video 41

HDMI

HDMI RGB Range 62

HDMI Video Input Specifications 113

HDMI Video Out Menu 82

HDMI In/Out Connectors 25

Height 29

Hidden Menus 57

Hidden Parameter Menus 46

Host, UPnP 100

I

I/O Status 49

ID LED 23

Import

Presets browser screen 102

Import All 102

Import All Presets

Presets browser screen 102

Inputs and Outputs

Selection and Format 15

Installation

Fiber I/O Options 28

Overview 27

Summary 27

Unpacking 28

Internal Test Signals to All Outputs 39

IP

IP Address 91

IP Address Menu 55

IP Config Menu 55

IP Address 47, 95

Default 31

IP Config 94

K

Knobs 18

L

LAN 30

LAN Connection Diagram 30

LAN LED 23
 LAN Specifications 117
 LED Indicators 22
 Legalizer Black Clip Menu 76
 Legalizer Chroma Clip Menu 76
 Legalizer White Clip Menu 76
 Loss of Input Menu 65

M

MAC Address Menu 56
 MADI BNC Connectors 25
 MADI BNC Out 64
 MADI Fiber Connectors 25
 MADI FiberOut 64
 MADI Status 50
 Manual, Contents Summary 17
 Matte Chroma Menu 72
 Matte Hue Menu 72
 Matte Luma Menu 72
 Menu Group Buttons 19
 Menu Groups

- Audio Output 21
- Audio Proc 21
- Audio Proc 1 and Audio Proc 2 105
- Config 20, 54
- Output 81
- Preset 20, 58
- Remote 19, 51
- Status 19, 48
- System 20
- Video Output 21
- Video Proc 20, 64

Menu Operation Examples 45
 Menu Page Types 44
 Menu Parameter Interactions 48
 Menus

- AES/EBU SRC 63
- AES/EBU SRC Mode 63
- AFD Out 77
- AFD VANC Output Lines 77
- Analog Audio Std 59
- Analog In Format 59
- Background Fill 67
- Caption Status 50
- Closed Captioning Translator 78
- Color Corrector (RGB) 73
- Color Green Gain 73
- Color Red Black Level 73
- Color Red Gamma 73
- Component Out 82
- Component Out Format 59
- Composite Downconv Crop 62
- Custom Aspect 74
- Custom Bottom Crop 74
- Custom H Position 74
- Custom Left Crop 74
- Custom Right Crop 74
- Custom Size 74
- Custom Size/Pos 73
- Custom V Position 74
- Default Gateway 55, 95
- Display Intensity 57
- Downconvert AFD Default 78
- Downconvert Mode 69
- Embedded Audio Out 88
- Factory Preset 58
- Fiber1 1080p50/60 Config 83
- Fiber1 Video Out 82
- Fiber1-3G Detect 61
- Fiber2 1080p Config 83
- Fiber2 Input Protect 61
- Fiber2 Video Out 82
- Frame Delay 67
- Frame Rate 61
- FRC Enable 61
- FRC Status 50
- Genlock Source 61
- Global Output 90
- GPI IN 1–4 Response 52
- GPI OUT 1–4 54
- HDMI RGB Range 62
- HDMI Video Out 82
- Hidden 57, 100
- I/O Status 49
- IP Address 55
- IP Config 55
- Legalizer Black Clip 76
- Legalizer Chroma Clip 76
- Legalizer White Clip 76
- Loss of Input 65
- MAC Address 56
- MADI BNC Out 64
- MADI Fiber Out 64
- MADI Status 50
- Matte Chroma 72
- Matte Hue 72
- Matte Luma 72
- Mix Down Input 87
- Mix Down Input Level 87
- Mix Down Input Mapping 87
- Mix Down Mode 86
- Mix Down Output Level 87
- NTSC Standard 62
- Output Format 65
- Output Status 50
- Output Timing H 66

- Output Timing V 67
- Power Supply Alarm 56
- Power/Temp Alarm Status 50
- Presets 1–40 58
- Proc Amp (YUV) 72
- Proc Amp Black 72
- Proc Amp Gain 72
- Proc Amp Hue 72
- Proc Amp Sat 73
- Reboot 57
- Reference Alarm 57
- Region of Interest 75
- Remote Control 51
- Reset Mapped Output 90
- Reverse Telecine 81
- Scan Format 79
- Screen Saver 57
- SD Aspect Ratio Convert 70
- SD Line 21 Blanking 79
- SDI Output Channel 89
- SDI1 1080p Config 82
- SDI1 Audio Out 88
- SDI1 Channel Pair Delay 85
- SDI1 Delay 84
- SDI1 Delay Global 84
- SDI1 Level 83
- SDI1 Phase 84
- SDI1 Video Output 81
- SDI1-3G Detect 59
- SDI2 1080p Config 82
- SDI2 Input Protect 60
- SDI2 Video Out 81
- Serial Number 57
- Sidebar Edge 71
- SNMP Enable 111
- SNMP Trap Destination 1 111
- SNMP Trap Destination 2 111
- SNMP Trap Port 1 111
- SNMP Trap Port 2 111
- Software Version 57
- Subnet Mask 55
- System Name 54
- System Status 51
- Test Pattern Video 80
- Upconvert Mode 68
- Vid 1 Format Alarm Status 49
- Vid 2 Format Alarm Status 49
- Vid 2 Format Status 49
- Vid1 Format Alarm 56
- Vid1 Format Status 49
- Vid2 Format Alarm 56
- Video 1 Freeze Output 80
- Video 1 Input Scan 79
- Video 1 Test Pattern 80
- Video 2 Freeze Output 80
- Video 2 Input 65
- Video 2 Input Scan 79
- Video Input 64
- Video Legalizer 76
- Video Output Mode 65
- Menus, Parameter 44
- Mix Down Input Level Menu 87
- Mix Down Input Mapping Menu 87
- Mix Down Input Menu 87
- Mix Down Mode
 - description 86
- Mix Down Mode Menu 86
- Mix Down Output Level Menu 87
- Multi-Channel 5.1 Mixdown Default 86
- Multi-Channel 7.1 Mixdown Default 86
- Multi-Channel Speaker Positions 86
- Multilevel Menus
 - Vid1 ProcAmp 46
- Multiple Field Parameter Menus
 - IP Address 47
- Multiple FS1-Xs
 - Control with Browser 92

N

- Name Entry Procedure 54
- Network
 - Connection Diagram 30
 - Default Gateway 95
 - Default Gateway Address 31
 - Default IP Address 31
 - Default Subnet Mask 31
 - IP Address 95
 - IP Config 94
 - Ping Test 33
 - Subnet Mask 95
 - UPnP Host 100
 - UPnP Proxy 101
- Network browser screen 94
- Network screen 98
- Networking
 - Default Static IP Procedure 31
 - HDCP Procedure 31
 - User Static IP Procedure 31
- NTSC 25, 62
 - NTSC Standard Menu 62
- NTSC Japan 62

O

- Octet Value Entry Procedure 55
- Operation Examples 45
- Operation Overview 15

- Operational Summary 19
- Output
 - Frame Delay Menu 67
 - Output Format Menu 65
 - Output Menu Group 81
 - Output Status 50
 - Output Timing H Menu 66
 - Output Timing V Menu 67
- Output Timing Memory 16
- Output Timing Ranges 66
- Outputs and Inputs
 - Selection and Format 15
- Overview 11
 - System Block Diagram 14
- Overview, Installation 27
- P**
- PAL 25
- PAL-M 62
- Panel
 - Description, Front 18
 - illustrations 18
 - Rear, Description 24
- Parameter
 - Menu Interactions 48
- Parameter Menus 44
- Phantom Power 36
- Physical Specifications 117
- Ping Test, Network 33
- Pinouts
 - Analog Audio 119
 - Audio 119
 - Digital Audio 119
 - GPI 118
- Power
 - Connection 27
 - Power Supply Alarm Menu 56
 - PWR 1/2 LEDs 23
 - Requirements and Warnings 29
 - Specifications 117
- Power Connectors 24
- Power Up
 - First Time 38
- Power/Temp Alarm Status 50
- Preset Button 20
- Preset Menu Group 20, 58
- Presets
 - Interactions with GPIs 54
 - Presets 1–40 Menu 58
 - Routing Audio with Video 58
- Presets browser screen 101
- Proc Amp
 - Proc Amp Black Menu 72
 - Proc Amp Gain Menu 72
 - Proc Amp Hue Menu 72
 - PROC AMP LED 22
 - Proc Amp Menu (YUV) 72
 - Proc Amp Sat Menu 73
- Proxy, UPnP 101
- Pushbuttons 19
- PWR 1/2 LEDs 23
- R**
- Rear Panel Description 24
- Reboot Menu 57
- Recall
 - Presets browser screen 102
- Recall (91.1) 102
- Redundant Power Supplies 27
- Ref Loop Connectors 25
- Reference
 - Overview 15
 - Ref Connector 23
 - Ref LED 23
 - Reference Alarm Menu 57
 - Termination 26
 - Video Reference Specifications 113
- Region of Interest 75
- Region of Interest Menu 75
- Remote browser screen 107
- Remote Button 19
- Remote Control Menu 51
- Remote LED 22
- Remote Menu Group 19, 51
- Reset Mapped Output Menu 90
- Resetting to Factory Setting
 - Browser Screens 93
- Retained Settings 16
- Reverse Telecine 80
 - Conditions 81
- Reverse Telecine Menu 81
- RGB
 - Color Green Gain Menu 73
 - Color Red Black Level Menu 73
 - Color Red Gamma Menu 73
 - RGB Color Corrector Menu 73
- S**
- Safety Statements 121
- Save (92.1) 102
- Scan Format Menu 79
- Screen Description
 - Browser 91
- Screen Saver Menu 57
- SD Aspect Ratio Convert Menu 70
- SD Line 21 Blanking Menu 79

- SD to Sidebar HD over Matte 40
- SDI
 - SDI video 25
 - SDI1 1080p Config Menu 82
 - SDI1 Video Output Menu 81
 - SDI2 1080p Config Menu 82
 - SDI2 Video Out Menu 81
- SDI In/Out Connectors 25
- SDI1 Audio Out Menu 88
- SDI1 Delay Global Menu 84
- SDI1 Delay Menu 84
- SDI1 Level Menu 83
- SDI1 Output Channel Menu 89
- SDI1 Phase Menu 84
- SDI1 Channel Pair Delay Menu 85
- Select and Adjust Knobs 21
- Serial Number 92
- Serial Number Menu 57
- Settings
 - Retained 16
- Shipping Box Contents 28
- Sidebar Edge Menu 71
- Sidebar Video Keying
 - Overview 16
- Simple Menus (Config Format Alarm Filters) 45
- Slider Operation
 - Browser Screens 93
- SNMP
 - SNMP Alarm Traps 109
 - SNMP Enable Menu 111
 - SNMP Interface 13
 - SNMP Trap Dest 1 & Dest 2 109
 - SNMP Trap Destination 1 Menu 111
 - SNMP Trap Destination 2 Menu 111
 - SNMP Trap Port 1 Menu 111
 - SNMP Trap Port 2 Menu 111
 - SNMP, FS1-X Implementation 109
- Software
 - Download 34
- Software Update Procedure 34
- Software Version 92
- Software Version Menu 57
- Source Memory 16
- Specifications
 - Appendix A 113
 - Audio I/O 116
 - Component Analog I/O 113
 - Conversion Exceptions 112
 - HDMI I/O 113
 - Physical 117
 - Power 117
 - Reference video 113
 - Video Formats 113
 - Video Input/Output 112
- Stand Alone Tests 38
- Status
 - Caption Status 50
 - FRC Status 50
 - I/O 49
 - MADI Status 50
 - Output Status 50
 - Power/Temp Alarm Status 50
 - Status Button 19, 48
 - Status Menu Group 19, 48
 - STATUS Menus 45
 - System Status 51
 - Vid 1 Format Alarm Status 49
 - Vid 2 Format Alarm Status 49
 - Vid 2 Format Status 49
 - Vid1 Format 49
- Status browser screen 97
- Store
 - Presets browser screen 102
- Subnet Mask 95
 - Default 31
- Subnet Mask Menu 55
- Summary, Installation 27
- Support, AJA Technical 92
- System
 - Block Diagram 14
 - System Button 20
 - System Menu Group 20
 - System Name Menu 54
- System Cable Connections 36
- System Status 51

T

- TASCAM-style Connector Pinout 119
- Technical Description 14
- Technical Support, AJA 92
- Test All Outputs 39
- Test Pattern Video Menu 80
- Timing
 - Ranges 66
- Typical Applications 12

U

- UFC LED 22
- Unpacking 28
- Upconvert Mode Menu 68
- Update Software 34
- UPnP Host 100
- UPnP Proxy 101

V

- Vid1 Format Alarm Status 49
- Vid1 Format Status 49

- Vid2 Format Alarm Status *49*
- Vid2 Format Status *49*
- Video
 - A/D, D/A Specifications *116*
 - Component Input Specifications *113*
 - Features *11*
 - HDMI Input Specifications *113*
 - VID IN 1/2 LEDs *22*
 - Vid1 Format Alarm Menu *56*
 - Vid2 Format Alarm Menu *56*
 - Video Format Specifications *113*
 - Video Incompatibility Alarms *23*
 - Video Input Format Specifications *112*
 - Video Input Menu *64*
 - Video Legalizer Menu *76*
 - Video Output Mode Menu *65*
 - Video Proc Menu Groups *64*
- Video 1 & 2 browser screens
 - Color Red Gain *73*
- Video 1 Freeze Output Menu *80*
- Video 1 Input Scan Format Menu *79*
- Video 1 Output Mode Menu
 - Video 1 Output Mode *65*
- Video 1 Test Pattern Menu *80*
- Video 2 Freeze Output Menu *80*
- Video 2 Input Menu *65*
- Video 2 Input Scan Format Menu *79*
- Video Conversion Procedure *15*
- Video Format Alarms *116*
- Video Output
 - Video Output Button *21*
 - Video Output Menu Group *21*
- Video Output browser screen *104*
- Video Proc
 - Video Proc Button *20*
 - Video Proc Menu Group *20*
- Video Proc browser screen *103*
- Video Processor
 - Technical Description *15*
- Video Processor 2
 - Bypass Channel *16*
- Video Processor Block Diagram *14*
- Video with Audio Routing
 - Using Presets *58*
- Voltage, AC *29*
- W**
- Warnings
 - AC Leakage Current *27*
 - AC Power *29*
 - Installation *27*
 - Safety *121*
- Web Browser Control *34, 91*
- Width *29*