

1 DESCRIPTION

The ASI574x series is a member of the new generation of professional PCI-Express sound card designed for use in radio broadcast automation.

The new half-height PCI Express card format allows use in 2U servers facilitating increased density for high channel count audio applications.

Providing 4 or 12 play streams that are mixed to 4 balanced stereo outputs and 4 or 8 record streams fed from 4 balanced stereo inputs, the ASI5788 features AudioScience's unique "anything to anywhere" mixing and routing.

The ASI5744 provides both balanced analog and AES/EBU inputs and outputs. The ASI5740 provides only balanced analog inputs and outputs while the ASI5741 provides only AES/EBU inputs and outputs. The maximum analog input and output level is +24dBu.

Uncompressed PCM, in a choice of precision is available for both recording and playback.

For surround sound applications, SSX™ mode allows multichannel streams of up to 8 channels to be played, recorded and mixed.



2 FEATURES

- 4 balanced stereo analog inputs and outputs with levels to +24dBu. (ASI5740 and ASI5744 only)
- 4 AES/EBU inputs and outputs with sample rate converters on all inputs. (ASI5741 and ASI5744 only)
- Dedicated AES/EBU and Word clock Sync input. (ASI5741 and ASI5744 only)
- 4 or 12 stereo streams of playback into 4 stereo outputs
- 4 stereo or 8 mono streams of record from 4 stereo inputs
- Formats include 8,16,24 and 32 bit PCM with sample rates to 96kHz
- SSX™ mode for multichannel record, playback and mixing
- 24bit ADC and DAC with 110dB DNR and 0.0015% THD+N
- SoundGuard™ transient voltage suppression on all I/O
- Half height PCI Express card format
- Up to 8 cards in one system
- Windows 10, 7, Server 2012/2008 and Linux software drivers available



3 BLOCK DIAGRAMS

3.1 4-Play Mode

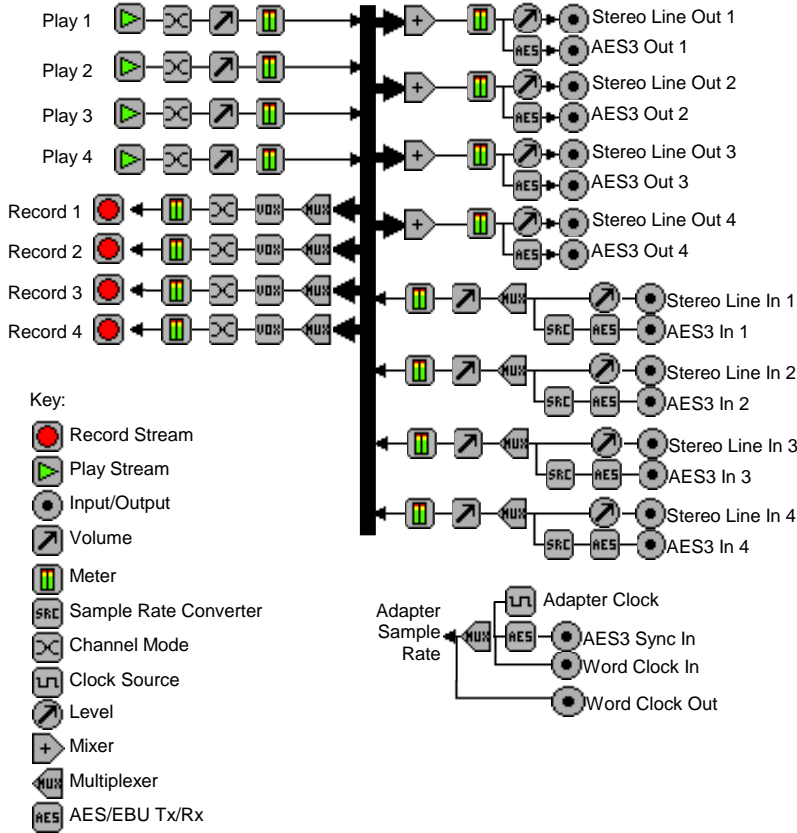
ASI5744 – 4 Play Mode

3.2 12 Play Mode

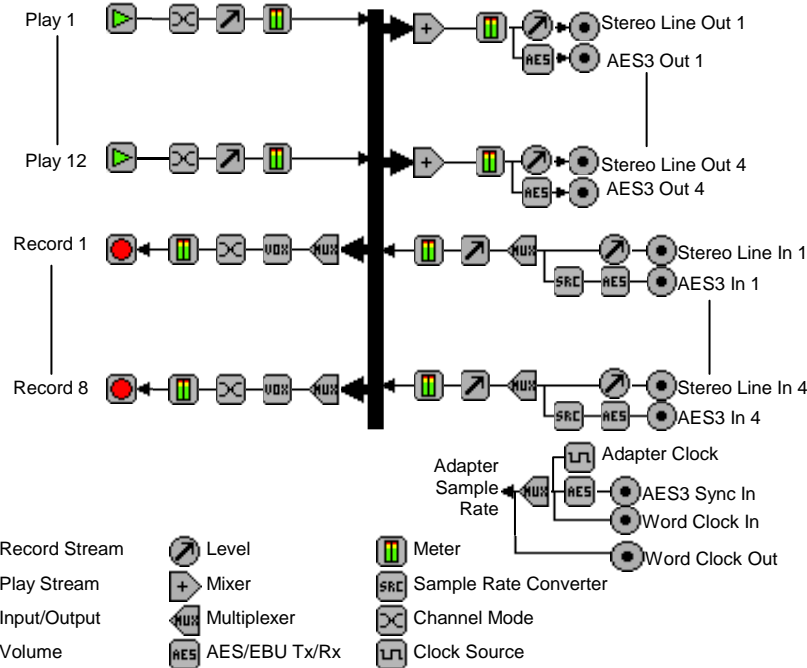
ASI5744 – 12 Play Mode

3.3 SSX2 Mode

ASI5744 – SSX Mode

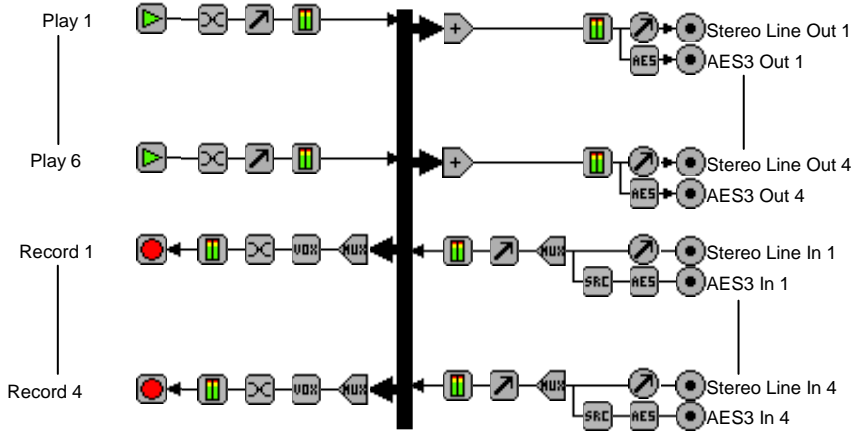

Key:

- | | | |
|---------------|---------------|-----------------------|
| Record Stream | Level | Meter |
| Play Stream | Mixer | Sample Rate Converter |
| Input/Output | Multiplexer | Channel Mode |
| Volume | AES/EBU Tx/Rx | Clock Source |

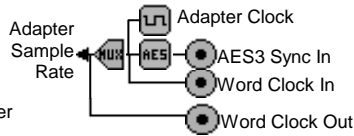

4 SPECIFICATIONS

ANALOG INPUT/OUTPUT [2]

Type	Balanced
Connector	68pin VHDCI
Input Level	-10 to +24dBu in 0.5dBu steps
Input Impedance	10K ohms
A/D converter	24bit Over sampling
Output Level	-10 to +24dBu in 0.5dBu steps
D/A converter	24bit Over sampling
Output Impedance	50ohms
Load Impedance	600ohms or greater
Dynamic Range [1]	>=110dB (record or play)
THD+N [1]	=<-96dB (0.0015%) (record or play)
Frequency Response	20Hz to 20kHz +0/-0.1dB 20Hz to 40kHz +0/-3dB
Inter-channel Phase	<0.1 degrees (record or play)
Inter-channel Crosstalk	>110dB (record or play)

DIGITAL INPUT/OUTPUT [3]

Type	AES/EBU (EIAJ CP-340 Type I / IEC-958 Professional)
Input/Output Impedance	110 ohms
Connector	68pin VHDCI
Sample Rates	32, 44.1, 48, 88.2, 96kHz with sample rate converters on inputs

SAMPLE RATE CLOCK

Internal (Adapter)	32, 44.1, 48, 88.2, 96kHz
AES/EBU Sync In [3]	32, 44.1, 48, 88.2, 96kHz on dedicated AES/EBU input
Word In/Out [3]	32, 44.1, 48, 88.2, 96kHz

SIGNAL PROCESSING

DSP	Texas Instruments TMS320DM8147 floating point DSP @ 600MHz
Memory	64MB
Audio Formats	8 bit unsigned PCM 16 bit signed PCM 32 bit floating point PCM

GENERAL

Bus	X1 PCI-Express.
Dimensions	PCI half-height form factor – 5.4" x 2.75" x 0.6" (138mm x 70mm x 15mm)
Weight	8 oz (227g) max
Operating Temperature	0C to 60C
Power Requirements	+3.3V@1.5A +12V @ 300mA

CABLES & BREAKOUT BOX

Analog [2]	CBL4004 + CBL1044 or BOB1038
AES/EBU [3]	CBL4104 + CBL1144 or BOB1038 [4]
	You will need one breakout box for each connection, if you intend to use both analog and digital you will need 2 BOB1038 breakout boxes

- Notes:**
- [1] Dynamic Range and THD+N measured using a +20dBu 1kHz sine wave sampled at 48kHz and A weighting filter.
 - [2] ASI5740 and ASI5744 only.
 - [3] ASI5741 and ASI5744 only.
 - [4] Cable includes GPIO connectors that are not used for these cards

5 REVISIONS

Date	Description
16 March 2015	Created doc and modified from ASI6788 datasheet
26 March 2015	Minor spec updates
10 October 2015	Spec update and added additional ASIControl sections
22 October 2015	Spec update
1 September 2017	Added ASI5740 and ASI5741
3 April 2019	Removed SRX from block diagrams
15 January 2020	Updated operating temp

6 CONTENTS

1	DESCRIPTION	1
2	FEATURES	1
3	BLOCK DIAGRAMS	2
3.1	4-PLAY MODE.....	2
3.2	12 PLAY MODE.....	2
3.3	SSX2 MODE.....	3
4	SPECIFICATIONS	4
5	REVISIONS	5
6	CONTENTS	6
7	CONNECTORS	8
7.1	68PIN VHDCI – DIGITAL (ASI5741 AND ASSI5744 ONLY).....	8
7.2	68PIN VHDCI – ANALOG (ASI5740 AND ASI5744 ONLY).....	8
8	CABLES AND BREAKOUT BOX	8
8.1	ANALOG (ASI5740 AND ASI5744 ONLY).....	8
8.2	AES/EBU (ASI5741 AND ASSI5744 ONLY).....	8
9	HARDWARE INSTALLATION	9
9.1	SETTING ADAPTER INDEX – ONE ADAPTER IN THE PC.....	9
9.1.1	<i>Setting Adapter Index - Two or More Adapters in the PC</i>	9
10	SOFTWARE INSTALLATION	10
10.1	DRIVERS FOR WINDOWS 10, 7, SERVER 2008, SERVER 2012.....	10
10.1.1	<i>Combo Driver</i>	10
10.1.2	<i>ASIO</i>	10
10.1.3	<i>Driver Failure</i>	10
10.2	DRIVERS FOR LINUX.....	10
10.3	APPLICATIONS FOR WINDOWS.....	10
10.3.1	<i>ASIControl</i>	10
11	OPERATION USING ASICONTROL	10
12	USER INTERFACE	11
12.1	ASICONTROL LAYOUT.....	11
12.1.1	<i>Adapter List Window</i>	11
12.1.2	<i>Adapter Topology Window</i>	11
12.1.3	<i>Node Controls Window</i>	11
12.1.4	<i>Adapter Information</i>	12
12.2	MODES.....	12
12.2.1	<i>Adapter Mode</i>	12
12.3	SSX2 MODE.....	13
12.3.1	<i>Enabling SSX2</i>	13
12.4	PLAYER.....	14
12.4.1	<i>Interface</i>	14
12.4.2	<i>How To Play a File</i>	14
12.4.3	<i>Using embedded sine wave generator</i>	14
12.4.4	<i>Developer</i>	15
12.5	RECORDER.....	15
12.5.1	<i>Interface</i>	15
12.5.2	<i>How To Record a File</i>	15
12.5.3	<i>Developer</i>	15
12.5.4	<i>Volume</i>	15
12.6	METER.....	16
12.6.1	<i>Interface</i>	16
12.6.2	<i>Developer</i>	17

12.7	CHANNEL_MODE	17
12.7.1	Interface	17
12.8	CLOCKSOURCEIN	17
12.8.1	Interface	18

7 CONNECTORS

7.1 68pin VHDCI – Digital (ASI5741 and ASSI5744 only)

AES/EBU

4 AES/EBU inputs
 4 AES/EBU outputs
 AES/EBU Sync in
 Word clock in/out

Relay 4B	68	34	Relay 4A
Relay 3B	67	33	Relay 3A
Relay 2B	66	32	Relay 2A
Relay 1B	65	31	Relay 1A
+3.3V	64	30	VOPT
Opto 16	63	29	Opto 15
Opto 14	62	28	Opto 13
Opto 12	61	27	Opto 11
Opto 10	60	26	Opto 9
Opto 8	59	25	Opto 7
Opto 6	58	24	Opto 5
Opto 4	57	23	Opto 3
Opto 2	56	22	Opto 1
GND	55	21	GND
AES3 Out 8-	54	20	AES3 Out 8+
AES3 Out 7-	53	19	AES3 Out 7+
AES3 Out 6-	52	18	AES3 Out 6+
AES3 Out 5-	51	17	AES3 Out 5+
AES3 Out 4-	50	16	AES3 Out 4+
AES3 Out 3-	49	15	AES3 Out 3+
AES3 Out 2-	48	14	AES3 Out 2+
AES3 Out 1-	47	13	AES3 Out 1+
GND	46	12	GND
AES3 In 8-	45	11	AES3 In 8+
AES3 In 7-	44	10	AES3 In 7+
AES3 In 6-	43	9	AES3 In 6+
AES3 In 5-	42	8	AES3 In 5+
AES3 In 4-	41	7	AES3 In 4+
AES3 In 3-	40	6	AES3 In 3+
AES3 In 2-	39	5	AES3 In 2+
AES3 In 1-	38	4	AES3 In 1+
AES3 Sync In-	37	3	AES3 Sync In+
GND	36	2	Word Out
GND	35	1	Word In

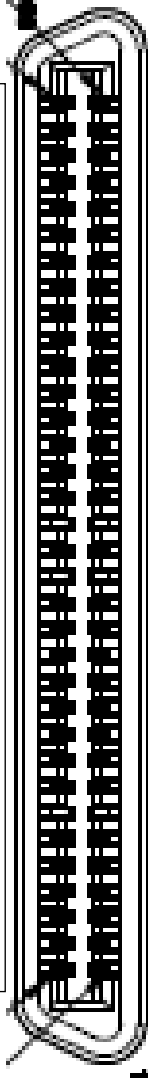

7.2 68pin VHDCI – Analog (ASI5740 and ASI5744 only)

Analog

4 balanced inputs
 4 balanced outputs
 4 grounds

AGND	1	35	AGND
Line In 1L-	2	36	Line In 1L+
Line In 1R-	3	37	Line In 1R+
Line In 2L-	4	38	Line In 2L+
Line In 2R-	5	39	Line In 2R+
Line In 3L-	6	40	Line In 3L+
Line In 3R-	7	41	Line In 3R+
Line In 4L-	8	42	Line In 4L+
Line In 4R-	9	43	Line In 4R+
Line In 5L-	10	44	Line In 5L+
Line In 5R-	11	45	Line In 5R+
Line In 6L-	12	46	Line In 6L+
Line In 6R-	13	47	Line In 6R+
Line In 7L-	14	48	Line In 7L+
Line In 7R-	15	49	Line In 7R+
Line In 8L-	16	50	Line In 8L+
Line In 8R-	17	51	Line In 8R+
AGND	18	52	AGND
Line Out 1L-	19	53	Line Out 1L+
Line Out 1R-	20	54	Line Out 1R+
Line Out 2L-	21	55	Line Out 2L+
Line Out 2R-	22	56	Line Out 2R+
Line Out 3L-	23	57	Line Out 3L+
Line Out 3R-	24	58	Line Out 3R+
Line Out 4L-	25	59	Line Out 4L+
Line Out 4R-	26	60	Line Out 4R+
Line Out 5L-	27	61	Line Out 5L+
Line Out 5R-	28	62	Line Out 5R+
Line Out 6L-	29	63	Line Out 6L+
Line Out 6R-	30	64	Line Out 6R+
Line Out 7L-	31	65	Line Out 7L+
Line Out 7R-	32	66	Line Out 7R+
Line Out 8L-	33	67	Line Out 8L+
Line Out 8R-	34	68	Line Out 8R+

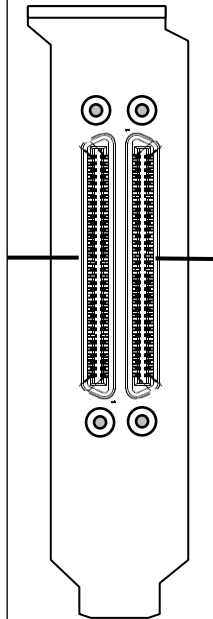
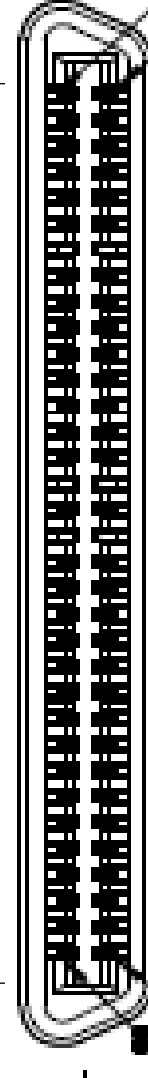

8 CABLES AND BREAKOUT BOX

You will need one breakout box for each connection, if you intend to use both analog and digital you will need 2.

8.1 Analog (ASI5740 and ASI5744 only)

CBL4004 plus CBL1044 or BOB1038

8.2 AES/EBU (ASI5741 and ASSI5744 only)

CBL4104 plus CBL1144 or BOB1038

9 HARDWARE INSTALLATION

This section explains how to install one or more AudioScience adapters in a computer.

9.1 Setting Adapter Index – One Adapter in the PC

1. Make sure your computer is turned off.
2. PCI adapters should be installed in any empty PCI slot and PCIe adapters should be installed in any x1 (or greater) PCIe slot.
3. Make sure the adapter jumper is set to adapter index #1, the factory default. For a new card no changes need to be made. For an AudioScience adapter from another installation, check that it is set to adapter index #1.

Depending on the adapter family, there are different ways of setting the adapter index.

For ASI5000 and ASI6000 families, there is an adapter jumper that must be set. The left most position represents adapter index #1.

For ASI5300, ASI6300, ASI8700, and ASI8900 families, there is a rotary switch.

NOTE: Position 0 (zero) represents adapter #1, position 1 is adapter #2, etc.

Adapter Jumper set to Adapter #1

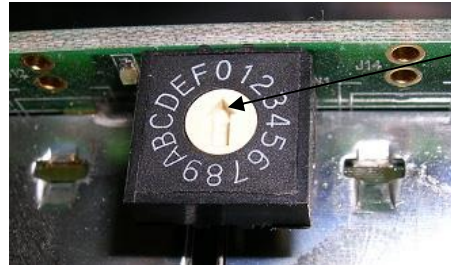
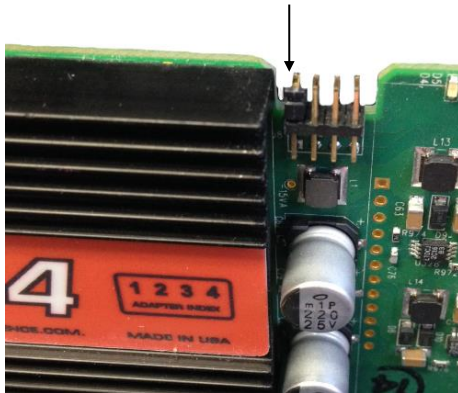

4. Turn on the computer and let it boot. Under Windows, a dialog box will pop up informing you that the computer has detected a new Multimedia Audio card. Cancel out of this dialog box and proceed to the software installation section of this datasheet.

9.1.1 Setting Adapter Index - Two or More Adapters in the PC

1. Make sure your computer is turned off.
2. PCI adapters should be installed in any empty PCI slots and PCIe adapters should be installed in any x1 (or greater) PCIe slots. Different adapter types can coexist in the same computer; for example, an ASI6416 and ASI8921 will work correctly if installed in the same PC. Different adapter types still require unique adapter index numbers.
3. Each adapter in the PC needs to have its adapter jumper/rotary switch position set to unique numbers. For example if you are installing two adapters, the first one would be set to adapter index #1 and the second to adapter index #2.
 - 3.1. For ASI5000 and ASI6000 families, the position to the right of index #1, when jumpered, represents adapter index #2. The next position represents #3, and the rightmost position, when jumpered, represents #4.
 - 3.2. For ASI5300, ASI6300, ASI8700, and ASI8900 families, rotate the rotary switch to indicate what position is required.

10 SOFTWARE INSTALLATION

AudioScience makes audio adapters and drivers for various operating systems. Enhancements to an adapter's utility come from the integrators software that uses the audio driver to implement sophisticated audio playback and recording functions.

10.1 Drivers for Windows 10, 7, Server 2008, Server 2012

Typically, drivers are not included with the hardware and will need to be downloaded from the AudioScience website. They can be found here: http://www.audioscience.com/internet/download/win_drivers.htm

The first step is to determine what type of driver is needed for your operating system. Drivers are available for 32-bit and 64-bit Windows systems.

Driver 3.10 and later present the user with three install options during installation:

- Install Standard PCI/PCIe Driver.
- Install Standard + Network Audio Driver.
- Remove all driver components

Traditional installs should select the first of these options. Users of AudioScience CobraNet and AVB products should select the second option with the "+Network Audio Driver." in the text.

10.1.1 Combo Driver

The Combo driver installs WDM devices by default and presents an option to "Install legacy 32-bit WAVE driver" in case your application requires it. Download the file named ASICOMBO_XXXXXX.EXE from www.audioscience.com and run it (_XXXXXX is the version number). After the EXE has run, reboot your computer and the audio adapter will be operational. If the cover is off the computer, one can see one or two blinking LEDs on top of the card indicating its DSP is running and communicating with the driver.

Verify that the adapter is running using ASIControl (see ASIControl section in this document).

10.1.2 ASIO

All AudioScience drivers also install an ASIO driver interface. It is installed by default.

10.1.3 Driver Failure

In the event that an adapter's driver fails to load correctly, the OS's event viewer should be checked. The event log is accessed from the Administrative Tools applet in Windows Control Panel under Event Viewer. The Windows Logs\System view should be selected.

If two or more adapters are installed in the same system, the first thing to check is that the adapters were assigned unique adapter numbers. If issues persist, please email support@audioscience.com.

10.2 Drivers for Linux

The latest Linux driver can be downloaded from the AudioScience website – www.audioscience.com

10.3 Applications for Windows

AudioScience provides ASIControl for adapter set-up and configuration.

10.3.1 ASIControl

All Windows drivers install an AudioScience application called ASIControl that can be used to setup and verify functionality of adapters. ASIControl provides a common interface for users across all driver types.

From the Windows Start menu, navigate to Start→Programs→AudioScience and run the ASIControl program.



11 OPERATION USING ASICONTROL

Using ASIControl, the ASI5744 will look similar to this:

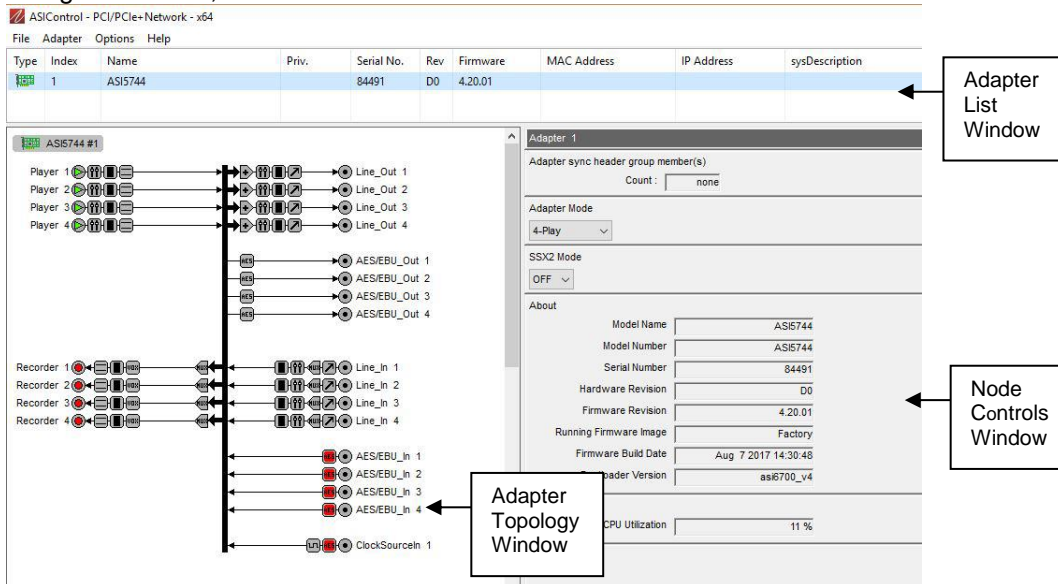

12 USER INTERFACE

12.1 ASIControl Layout

ASIControl consists of three main windows: the adapter list in the top portion of the window, the adapter topology view on the left hand side, and the node control list on the right hand side.

12.1.1 Adapter List Window

The top portion of ASIControl shows a list of all the adapters that the application has found. By default, only bus based (i.e. PCI and/or PCI Express) adapters will be shown. If the network portion of the driver is installed (by selecting “Install Standard + Networked Audio Driver” after running the driver installer) and “Local PCI(e) + Networked adapters” is selected from ASIControl’s Options→Configure adapter interface, then AudioScience and other third party CobraNet devices will be shown.

Adapters are listed in order of adapter index. For bus-based adapters, this is determined by the adapter index jumper on the card. For AudioScience CobraNet devices this is calculated from the unit’s MAC address. Third party CobraNet devices are listed last as they have no AudioScience index.

12.1.2 Adapter Topology Window

The left hand side of ASIControl contains the topology view of the adapter. It is essentially a block diagram of the device showing the available physical inputs and outputs on the right hand side of the black, vertical ‘bus’ line. On the left hand side of the bus line, bus-based adapters show player and recorder streams, while CobraNet adapters show their network connections.

Each of the inputs and outputs is referred to as a node and each Node contains one or more controls. The topology shows each control as a small icon. A non-exhaustive list of nodes follows:

- | | | |
|-------------|-----------------|--------------|
| Line In | Player | CobraNet In |
| Line Out | Recorder | CobraNet Out |
| AES/EBU In | Tuner | |
| AES/EBU Out | Clock Source In | |

Hovering the mouse over a particular node will highlight it. Clicking on a node will bring up the controls resident on that node in the right hand control list.

There is an adapter node in the top left corner of the topology window. Clicking on this will show adapter-specific controls and properties on the right hand side. Not all adapters have all nodes.

12.1.3 Node Controls Window

The right hand side of ASIControl shows the controls associated with the selected node in the topology view. The controls are arranged, from top to bottom, in order of audio signal flow, i.e. the audio signal can be viewed as entering the node at the top control and leaving at the bottom control. Controls may be used to either manipulate the audio as it passes through the node, or report back control status information.

For a comprehensive listing of controls and how to operate ASIControl, please see the ASIControl manual available from www.audioscience.com and also installed by the driver. Not all adapters have all controls. The section below lists some common and any specific controls, as seen in ASIControl, for this adapter.

12.1.4 Adapter Information

This control displays information about the installed AudioScience product.

12.1.4.1 Interface

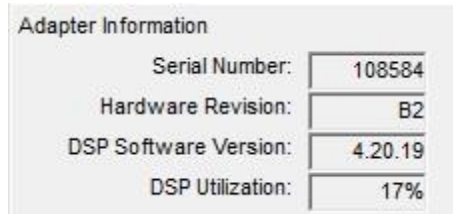

Adapter information seen in right side of ASIControl.

Serial Number:

The serial number is displayed here.

Hardware Revision:

This lists the hardware revision of the AudioScience product.

DSP Software Version:

The DSP software version is displayed; usually the same as the driver version installed.

DSP Utilization:

This shows the loading of the AudioScience product's DSP in percent.

Note: Utilization should be kept below 90%.

12.2 Modes

Selecting the appropriate mode from the list using the dropdown arrow changes the Adapter_Mode setting. A reboot is necessary after changing adapter mode. The mode setting is saved to the adapter's EEPROM.

12.2.1 Adapter Mode

The Adapter_Mode control changes the number of players/recorders/lineouts that an adapter has. On certain adapters, not all sample rates/formats are supported; changing the mode of the adapter allows for best functionality with certain sample rates/formats. Different adapters will have different modes available, and not all adapters have modes. Please see datasheets on specific adapters, available at www.audioscience.com for more.

12.2.1.1 Interface



The ASI5744 supports four adapter modes: 4-Play, 12-play, Mono, and Low Latency.

12.2.1.2 4-Play

This mode supports 4 mono/stereo Play streams and 4 mono/stereo Record streams with full mixing capabilities.

12.2.1.3 12-Play

This mode supports 12 mono/stereo Play streams and 8 mono/stereo Record streams with full mixing capabilities.

12.2.1.4 Mono

This mode supports 8 Play streams and 8 Record streams with full mixing capabilities. Mono mode supports mapping a single Play or Line_In device to a single Line_Out channel.

12.2.1.5 Low Latency

This mode supports a single multichannel audio stream enabling live sound processing in ASIO and Core Audio applications. See the [Low Latency Mode datasheet](#) for further information.

12.3 SSX2 Mode

The AudioScience Surround Sound eXtension v2 (SSX2) mode control changes the players/recorders of an adapter to be able to play/record multichannel files of 2, 4, 6, or 8 channels. Implementing SSX2 mode is slightly different depending on what driver version is installed with the AudioScience adapter' see below.

SSX2 Mode and Adapter Mode can be used in conjunction with each other. Set the required Adapter Mode (Mono mode cannot be used with SSX2 Mode), set SSX2 Mode to On and then reboot. For example, an ASI6518 set to "16-Play" in Adapter Mode and "On" in SSX2 Mode will show 4 multichannel players after reboot. An ASI6518 set to "8-Play" in Adapter Mode and "On" in SSX2 to on will show 2 multichannel players after reboot.

Note that in ASIControl, the Player volumes cannot be unlocked to move the left and right channels independently when an adapter is in SSX2 mode. For further information on SSX2, see its datasheet under the Technology section at www.audioscience.com.

12.3.1 Enabling SSX2

12.3.1.1 Interface



Figure 1. SSX2 Mode seen in right side of ASIControl.

Selecting "On" using the dropdown arrow changes the SSX2 Mode setting. A reboot is necessary after changing the mode setting. The mode setting is saved to the adapter's EEPROM. After rebooting, one multichannel play or record stream will be created for each 4 play or record streams on the adapter.

12.4 Player

The Player control supports playback of an audio file from the computer's hard drive.

12.4.1 Interface

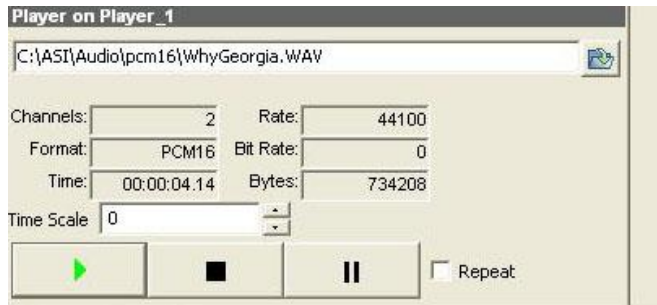

Figure 2. A player in ASIControl.

The first line of static text contains the selected playback file. Below the filename is the file information; playback time and playback bytes, the timescale select options, the player control buttons and the file repeat option.

12.4.2 How To Play a File

The first step in playing a file is to select the file to play. Use the **file icon button** to navigate to the desired file. After opening the file, the complete filename, including the path, will appear immediately to the left of the file open icon. At this point the file information is also filled in so that it contains the following fields: **Channels**, **Rate**, **Format**, and **Bit Rate**. Most of these are self-explanatory. The **Rate** refers to the sample rate of the audio recorded in the file. The **Bit Rate** applies only to MPEG compression and is set to 0 for all other formats.

At this point the percentage time scaling without pitch shift can be set if desired. The default of 0 indicates that time scaling is disabled. The valid range of settings is +/- 20 percent.

The **Repeat** check box indicates whether the file should be played again after playback has completed. It can be set either before playback has begun, or while playback is underway.

The file is now ready to be played. To start playback press the **play button**. At this point the **Time** and **Bytes** fields report playback time and the number of bytes of the file that have been played.

Once playback has started the **stop** and **pause buttons** can be used to stop or pause the playback.

12.4.3 Using embedded sine wave generator

Manually typing in a filename of "~" and pressing play will cause a full-scale 1 kHz sine wave to be played at 48 kHz. The format of the filename string is: "~w, c,f,a,m,s,t".

w = waveform = SINE (default=SINE)
c = channels = 1...8 (default = 2)
f = frequency = 1000 for 1kHz (default=1000)
a = amplitude = -1 for -1dBFS (default=0dBFS, i.e. full scale)
m = channel mask = 10 for left only, 01 for right only, 11 for stereo, etc. (default=1 for all channels)
t = sample type = (PCM8, PCM16, PCM24, PCM32, FLOAT32) (default=FLOAT32)
s = sample rate = positive integer (default=48000) [validity depends on adapter]

Defaults can be used if the complete string is not specified, i.e. "~" becomes "~wSINE,c2,f1000,a0,m11,s48000,tFLOAT32"

Any subset of the options may be specified, the remaining options will be set to the defaults. e.g. "~f500" = 500Hz stereo sine wave at 0dBFS, 48kHz sample rate.

12.4.4 Developer

12.4.4.1 Windows APIs

Wave – waveOutOpen(), waveOutWrite(), waveOutClose() etc.

HPI – Output stream functions documented [here](#).

ASX – ASX Player control functions documented [here](#).

12.4.4.2 Linux APIs

HPI – Output stream functions documented [here](#).

ASX – ASX Player control functions documented [here](#).

ALSA – <https://www.alsa-project.org/alsa-doc/alsa-lib/>

12.5 Recorder

The Recorder control supports recording of an audio file.

12.5.1 Interface

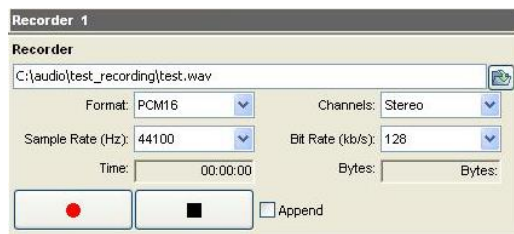

A recorder in ASIControl.

The first box contains the name given to the recorded file and the location where it is to be saved. Below that is the file information, the record time and record bytes, the recorder control buttons and the file Append option.

12.5.2 How To Record a File

The first step in recording a file is to have audio coming into the adapter. This can be from a line-in or from one of the players in ASIControl. See appropriate sections in this datasheet to accomplish this. Next, the new file needs a name and place to be saved, or an existing audio file can be selected to be overwritten or appended to. Use the **file icon button** to navigate to the location to create the file and to give it a name, or to open a previously recorded file to overwrite or append to it. Next, from the dropdown arrows, select the number of “**Channels**”, the “**Sample Rate**”, the “**Format**”, and the “**Bitrate**” that the file should be recorded in.

Check the **Append** checkbox to save the audio to the end of an already existing file.

The file is now ready to be recorded. To start recording, press the **record button**. At this point the “**Time**” and “**Bytes**” fields report record time and the number of bytes of the file that have been recorded.

Once recording has started the **stop** and **pause buttons** can be used to stop or pause the playback.

12.5.3 Developer

12.5.3.1 Windows APIs

Wave – use waveInOpen(), waveInStart() etc.

HPI – use [HPI_InStreamxxx\(\)](#) functions.

ASX – use [ASX_Recorder_xxx\(\)](#) functions.

12.5.3.2 Linux APIs

HPI – use [HPI_InStreamxxx\(\)](#) functions.

ASX – use [ASX_Recorder_xxx\(\)](#) functions.

ALSA – <https://www.alsa-project.org/alsa-doc/alsa-lib/>

12.5.4 Volume

The Volume control allows the audio signal’s gain to be altered in the range of –100 to +20dB.

12.5.4.1 Interface

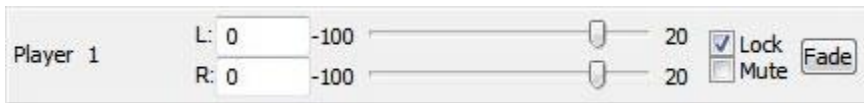

A Player volume in ASIControl.

Left and **Right** display boxes:

Displays the gain settings that the slider bars are set to.

Slider Bars:

Click on the bar with the mouse and drag to desired gain. Once the bars are selected, the left and right arrow keys can also be used to change the settings.

Lock:

When checked, locks the left and right channels to the same gain value. When unchecked, allows the left and right channels to have independent gains. (Note that if an adapter is in SSX2 mode, the Player volumes cannot be unlocked to move the left and right channels independently.)

Mute:

Check this box to mute the volume.

Fade:

When pressed, automatically fades the volume to the opposite end of the scale.

12.5.4.2 Developer

12.5.4.2.1 Windows APIs

Wave/Mixer – MIXERCONTROL_CONTROLTYPE_VOLUME

This is a Windows standard volume control. Settings are in the range of 0 to 65535, where 0 completely mutes the output and 65535 is the maximum volume.

HPI – [HPI_Volume](#) APIs.

ASX – [ASX_Volume](#) APIs.

12.5.4.2.2 Linux APIs

HPI – [HPI_Volume](#) APIs.

ASX – [ASX_Volume](#) APIs.

ALSA – <https://www.alsa-project.org/alsa-doc/alsa-lib/>

12.6 Meter

Meters in ASIControl are located on audio nodes and display the audio level as the audio signal passes through the node. Most AudioScience devices return both RMS and peak level readings and ASIControl displays both simultaneously.

12.6.1 Interface

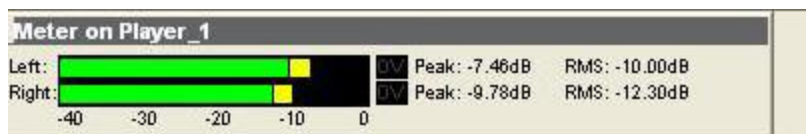

Figure 3. A stereo peak meter display. The RMS is the green bar and the peak is the yellow bar.

To the right of the peak meter is the absolute readings in dBFS. These can be useful when testing input tones of a specific known level.

12.6.2 Developer

12.6.2.1 Windows APIs

Wave/Mixer – Meters are read using mixerGetControlDetails() on a control of type signed and with type “Peak” the name “Peak Meter”. A minimum value is 0 and maximum is 32767. The interface returns the peak readings only, not the RSM level. It confirms to expected Windows functionality.

HPI – Meters are read using the [HPI_Meterxxx\(\)](#) API.

ASX – Meters are read using the [ASX_Meter_xxx\(\)](#) API.

12.6.2.2 Linux APIs

HPI – Meters are read using the [HPI_Meterxxx\(\)](#) API.

ASX – Meters are read using the [ASX_Meter_xxx\(\)](#) API.

ALSA – <https://www.alsa-project.org/alsa-doc/alsa-lib/>

12.7 Channel_Mode

The channel mode is a mechanism for handling mono to stereo conversions and directing the output to either left or right channels, as well as outputting left to stereo and right to stereo.

12.7.1 Interface

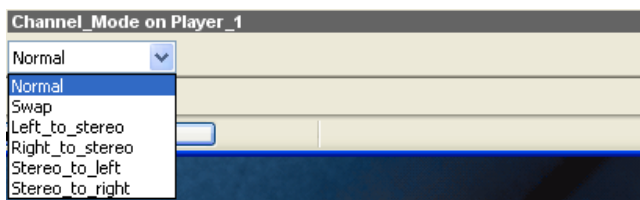

ASIControl view of a player’s channel mode control.

Default playback of either mono or stereo files causes audio to be output from the player on both the left and right audio channels. The channel mode control can allow the audio to be directed to either the left only or the right only. Select a channel mode setting from the dropdown list. Valid settings are:

Normal – left channel out left channel, right channel out right channel

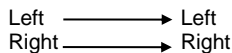

Swap – left channel out right channel and right channel out left channel



Left_to_stereo – left channel out to both left and right channels

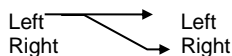

Right_to_stereo – right channel out to both left and right channels

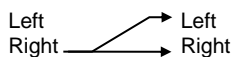

Stereo_to_left – left and right channels out to left channel

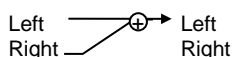

Stereo_to_right – left and right channels out to right channel

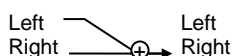

12.8 ClockSourceIn

In the topology pane of ASIControl, click on Clock Source 1

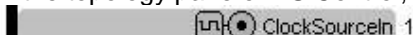

and in the node pane, select where the adapter is to get its clock source from using the Clock Source dropdown list, as well as the sample rate to use if clocking from adapter.

Note that for CobraNet and Livewire devices, the sample rate is fixed at 48kHz.

12.8.1 Interface



Clock Source information as seen in ASIControl.

Local Rate:

Select from the dropdown list the supported rates of the adapter.

Clock Source:

From the dropdown list, select the source for the adapter's clocking. Selections, depending on the adapter, include:

- Local – adapter rate is used; select a supported sample rate in Local Rate dropdown list
- Word – Word clock from Word clock BNC connector on digital cable loom (or BOB1024)
- WordHeader – Word clock from header on adapter (ASI61xx only)
- AES/EBU Sync – AES/EBU Sync from AES/EBU Sync XLR connector on digital cable loom (or BOB1024)
- AES/EBU In 1-4 – rate taken from specific digital input
- AES/EBU Auto – rate taken from first valid digital input; looks at digital input 1 first, then up to digital input 4
- Blu link

Adapter Rate: Displays the current adapter operating rate

<end>