

BROADCAST[®] tools INC

PROBLEM SOLVED

Installation and Operation Manual

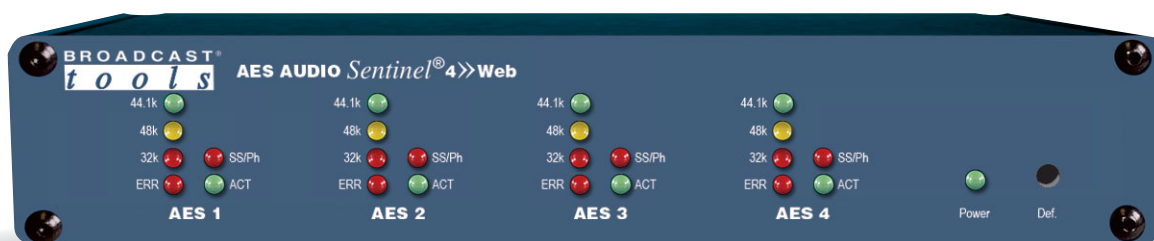

AES Audio Sentinel® 4 » Web *Web-enabled four channel AES/EBU silence monitor.*

Manual update: 8/2/2022

If you need a firmware upgrade, contact Broadcast Tools®
For firmware versions equal to or greater than 0.6

No part of this document may be reproduced or distributed without permission.
ALL SPECIFICATIONS AND FEATURES FOR THIS PRODUCT ARE SUBJECT TO
CHANGE WITHOUT NOTICE

NOTE: We recommend the use of Chrome, Firefox or Safari as your browser.

Due to the dynamic nature of product design, the information contained in this document is subject to change without notice. Broadcast Tools, Inc., assumes no responsibility for errors and/or omissions contained in this document. Revisions of this information or new editions may be issued to incorporate such changes.

*Broadcast Tools® is a registered trademark of Broadcast Tools, Inc.
All Sentinel® labeled products are registered trademarks of Broadcast Tools, Inc.
Copyright® 1989 - 2022 by Broadcast Tools, Inc. All rights reserved.
No part of this document may be reproduced or distributed without permission.*

Visit www.broadcasttools.com for important product update information.

Table of Contents

Section Title	Page #
Introduction	3
Safety Information	3
Who to Contact for Help	3
Product Overview	4
Inspection	5
Installation	5
Surge Protection	5
UPS Standby Power System	5
Power Supply connection	5
LED Indicators	5
Restoring Factory Defaults	6
Audio Input Connections	6
Remote Alarm Connections	7
LAN / NET Ethernet Jack	7
Chassis ground	7
Ethernet “Quick Start” Guide	8
Opening the LOGIN Web Page	11
Web Setup/Operation	11
“Login” Web Page	12
“Monitor/Control” Web Page	13
“User Setup” Web Page	14
“Silence Sensor Setup” Web Page	15
“Email/Network Setup” Web Page	16
“Show Log” Web Page	21
“About” Web Page	22
Specifications	23
Warranty	24
Connector Layout	Appendix
Front and Rear Panel silkscreen views	Appendix
Functional Diagram	Appendix

WEBSITE:

Visit our web site for product updates and additional information.

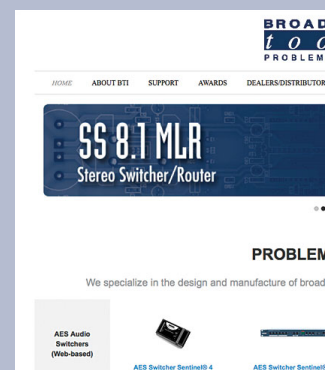

CONTENTS

INTRODUCTION

Thank you for your purchase of a Broadcast Tools® AES Audio Sentinel® 4 » Web Web-enabled two channel stereo silence monitor/audio switcher (referred to as the AES Audio Sentinel 4 throughout this manual). We're confident that this product will give you many years of dependable service. This manual is intended to give you all the information needed to install and operate the Broadcast Tools® AES Audio Sentinel 4.

SAFETY INFORMATION

Only qualified technical personnel should install the AES Audio Sentinel® 4 » Web. Any attempt to install this device by a person who is not technically qualified could result in a hazardous condition to the installer or other personnel or damage to the AES Audio Sentinel® 4 » Web or other equipment. Please ensure that proper safety precautions have been taken before installing this device. If you are unfamiliar with this type of equipment, please contact a properly qualified engineer to handle the installation and setup of the AES Audio Sentinel® 4 » Web.

WHO TO CONTACT FOR HELP

If you have any questions regarding your product or you need assistance, please contact your distributor from whom you purchased this equipment. If you would like more information about BROADCAST TOOLS® products, you may reach us at:

Broadcast Tools, Inc.

131 State Street
Sedro-Woolley, WA 98284-1503 USA
Voice: 360.854.9559
Fax: 866.783.1742

Internet Home Page: www.broadcasttools.com
E-mail: support@broadcasttools.com

**THANK YOU FOR CHOOSING
BROADCAST TOOLS® BRAND PRODUCTS!**

Broadcast Tools is a Veteran Owned Business



Designed, Assembled and Supported in WA State, USA



Broadcast Tools® Products, as with any electronic device, can fail without warning. Do not use this product in applications where a life threatening condition could result due to failure.



This manual should be read thoroughly before installation and operation.

WEBSITE:

Visit our web site for product updates and additional information.

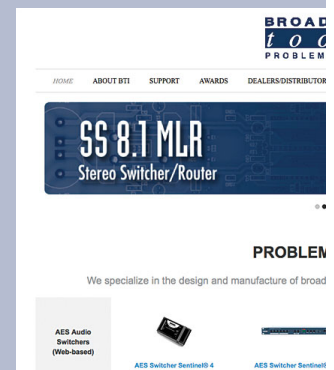

Product Overview

The AES Audio Sentinel® 4 >> Web is a web-enabled four channel AES/EBU digital audio silence monitor. Each of the four AES inputs can be configured for silence, stereo out of phase, and AES error monitoring. Inputs may be configured to act as two separate mono channels, allowing the user to monitor up to a total of eight different mono audio sources.

The AES Audio Sentinel® 4 >> Web can be configured and monitored locally and/or remotely over any IP network, including private networks, IP-based industrial control networks, and the Internet. Users can operate the product using a desktop web browser or web-enabled mobile device. Email notification may be configured to alert up to eight recipients when silence or out of phase audio is detected. SMTP username and passwords using STARTTLS (Gmail etc.) and Base64 authentication are supported.

Logging of system status, along with the site ID may be emailed in time spans from once an hour to once a day. SNMP traps and SET/GET to allow multiple units to be monitored and configured with SNMP management software.

Features/Benefits

- Built-in web server provides simple, web-based notification, monitoring, configuration, control.
- Four stereo silence, phase, and AES error sensors with front panel activity, sample rate, and alarm LED indicators.
- Silence trip level detection from -12dB to -36dB in 1 dB steps for each channel.
- Precise alarm time delay from 0(OFF) to 65535 seconds (18 hours, 12 min and 15 sec's). in one-second increments for each channel.
- Alarm restore time delay from 0(OFF) to 65535 seconds (18 hours, 12 min and 15 sec's). in one-second increments for each channel.
- Email notification may be configured to alert up to EIGHT recipients when alarms are detected.
- Email logging of system status, along with the site ID may be emailed in time spans from once an hour to once a day.
- Support for STARTTLS secure SMTP authentication.
- Neutrik XLR input jacks.
- Eight open collector alarm outputs on removable euroblock-style screw terminal connectors.
- Powered by a high-performance ARM® Cortex™ processor.
- Fully RFI proofed.
- Surge protected internal power supply, 12 VDC universal AC input desktop power supply with IEC AC inlet and domestic cable included.
- Up to two units may be mounted on the optional RA-1 rack shelf. Desktop and wall mounting is also possible.

WEBSITE:

Visit our web site for product updates and additional information.

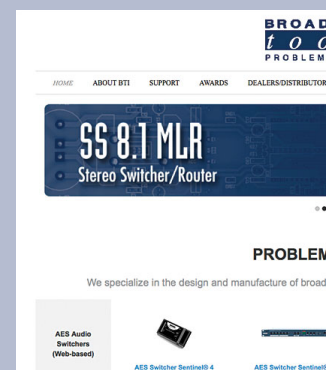

OVERVIEW

Inspection

Please examine your AES Audio Sentinel® 4 carefully for any damage that may have been sustained during shipping. If any damage is noted, please notify the shipper immediately and retain the packaging for inspection by the shipper. The package should contain the AES Audio Sentinel® 4, a 7-foot BLUE straight-through CAT 5 cable, a 7-foot GRAY crossover CAT 5 cable and a 12 VDC wall power supply. Manuals may be downloaded from our web site.

Installation

CAUTION! Installation of the AES Audio Sentinel® 4 in high RF environments should be performed with care. The station ground should be connected to the “Chs Gnd” chassis ground screw.

Surge Protection

The AES Audio Sentinel® 4 has built-in resistance to voltage changes; we recommend that you use a power surge protector or line conditioner on the incoming AC line. Lightning strikes and/or other high voltage surges may damage your AES Audio Sentinel® 4 and connected equipment if it is not properly protected. For lightning protection devices, check out www.polyphaser.com and www.itwlinx.com.

UPS Standby Power System

We recommend that you connect your AES Audio Sentinel® 4 to a UPS system. A UPS, like the BE600M1 from APC helps to minimize the risk to the AES Audio Sentinel® 4 and provides power during a power outage.

Mounting

The AES Audio Sentinel® 4 is designed to be rack mounted in the optional “RA-1” 19” 1-RU rack shelf. It should be mounted in an area that is accessible from the rear and preferably away from sources of heat. We recommend that you bench test and become familiar with the operation of the unit before permanently installing it.

Power Supply connection

Connect the 2.1mm barrel type center positive power connector into the “PWR” jack on the back of the unit and the 12 VDC power supply with domestic connector into a 120 Vac 50-60 Hz power source.

NOTE: Never use any type of power supply other than the specified/supplied power supply.

WEBSITE:

Visit our web site for product updates and additional information.

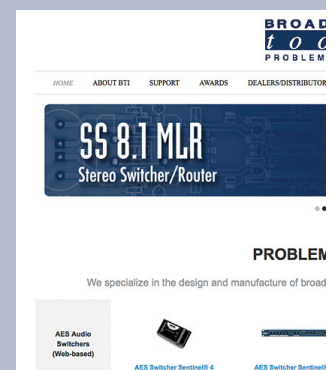

INSTALLATION

Installation/Operation

The AES Audio Sentinel® 4 is configured and monitored over Ethernet using its web browser interface. The slow blinking front panel “Power” LED indicates valid power and proper operation. The front panel is equipped with LEDs to indicate input sample rate, error, silence alarm, out of phase alarm or valid activity audio.

Front Panel:

LED Indicators

“Power” LED: Flashes when power is applied and operational. (Green)

“ACT” Activity LEDs: Lit when the input channel audio is above the silence threshold. (Green)

“SS/Ph” LEDs: Lit when the input is in silence alarm, or stereo out of phase alarm. (Red)

“32k” “44.1k” “48k” LEDs: Illuminate to indicate AES sample rate detected on input.

“ERR” Error LED: Lit = AES not detected or invalid data on input. (Red)

Defaults Button

The defaults button is located behind a recessed opening to left of the front panel Power LED. To reset the unit to default settings, apply power and wait for the Power LED to begin flashing normally then hold down the defaults button for 10 seconds. Releasing the defaults button will trigger a reset to defaults.

Rear Panel:

Chassis Ground screw (CHS GND)

The #4-40 sized chassis ground screw should be tied to the station (house) or system ground.

LAN / NET Jack

RJ45 Ethernet jack for 10/100baseT LAN/WAN connection.

AES/EBU Inputs

The AES Audio Sentinel 4’s four AES inputs are 3-pin XLR-F jacks labelled “AES In 1” “AES In 2” etc. Each input feeds a DAC with stereo silence, phase, and AES error detector.

XLR Connector Pinout

The AES Input XLR connector pinouts conform to 3-pin XLR wiring standards: Pin 1 = Ground/shield. Pin 2 = Positive. Pin 3 = Negative.

For AES/EBU signals please use AES/EBU digital audio qualified cable.

WEBSITE:

Visit our web site for product updates and additional information.

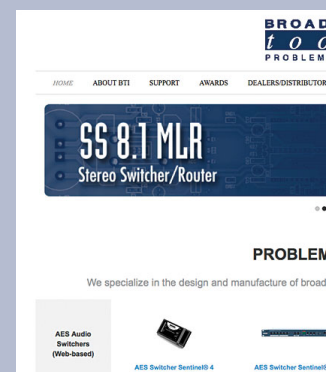

INSTALLATION

Remote Alarm Outputs

The AES Audio Sentinel® 4 has eight alarm status open collector outputs, one for each silence sensor. The on alarm the open collector output will go low to ground providing a return for an LED indicator, TTL/CMOS logic, or a relay. External pull-up resistors may be required in some installations, voltages must be limited to 6 VDC at 100 mA.

(J5 Top)

OC5	OC6	OC7	OC8	GND
OC1	OC2	OC3	OC4	GND

(J5 Bottom)

NOTE: PCB Revision A and higher: open collector voltage limit can be increased to 12 VDC by moving the JP10 jumper from the “5V” position to the “VIN” position.

WEBSITE:

Visit our web site for product updates and additional information.

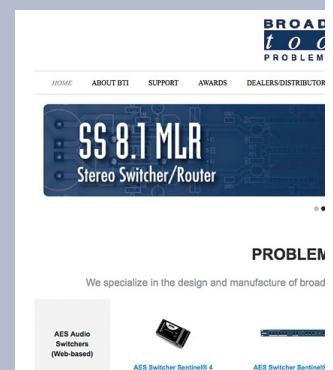

Web Setup and Operation

Ethernet “Quick Start” Guide

CAUTION! If you are not familiar with Ethernet enabled equipment, it may be useful to contact your IT department, network administrator or network consultant for assistance. Assigning an IP address already in use by another device may cause problems with your network!

Instructions for changing the IP address of the computer that will be used for the configuration of this product are given here. Note that these instructions are specifically for computers with the Windows 10 operating system but will also work with Windows 7. For setup using other operating systems, refer to the appropriate OS user’s manual.

Step 1: Open the control panel by clicking on the Start Menu, click on settings, then click on Control Panel. Click on View network status and tasks under Network and Internet.

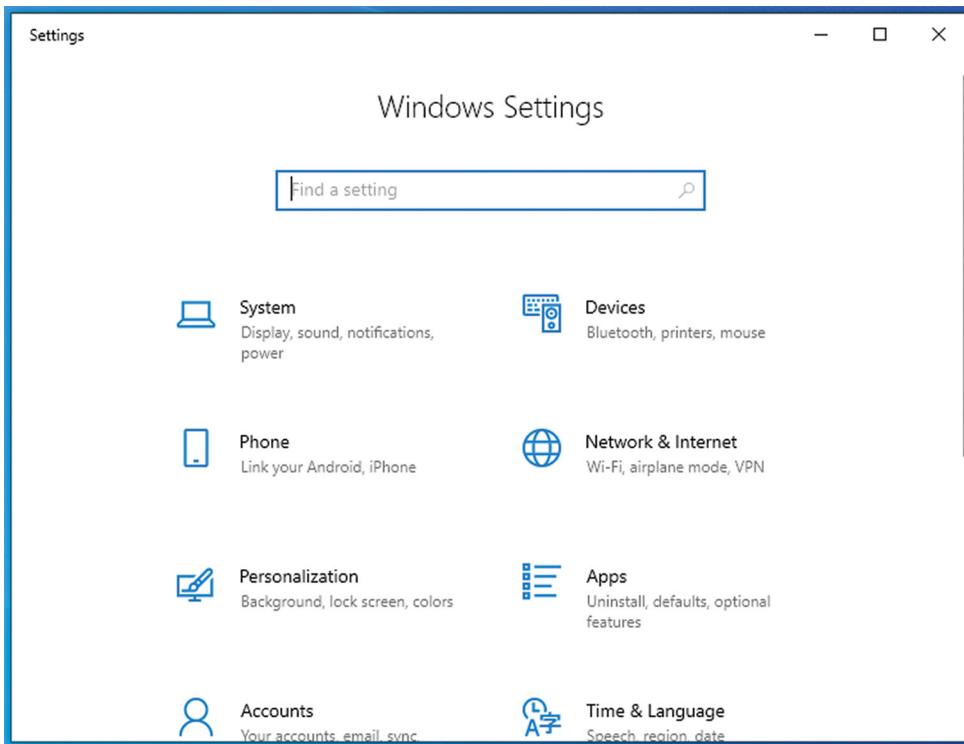

NEVER DOWNLOAD FIRMWARE UPDATES OR CHANGES TO THE BNET WEBSERVER UNLESS INSTRUCTED TO DO SO BY BROADCAST TOOLS®. DOING SO DELETES ALL SOFTWARE AND VOIDS ALL WARRANTIES FROM BROADCAST TOOLS, INC.

WEBSITE:

Visit our web site for product updates and additional information.

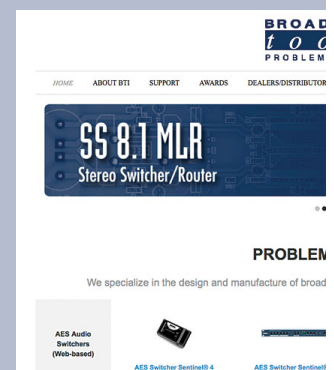

Ethernet “Quick Start” Guide

Step 2: Click on the sidebar labelled Change adapter settings. The Network Connections windows will pop up, as shown below.

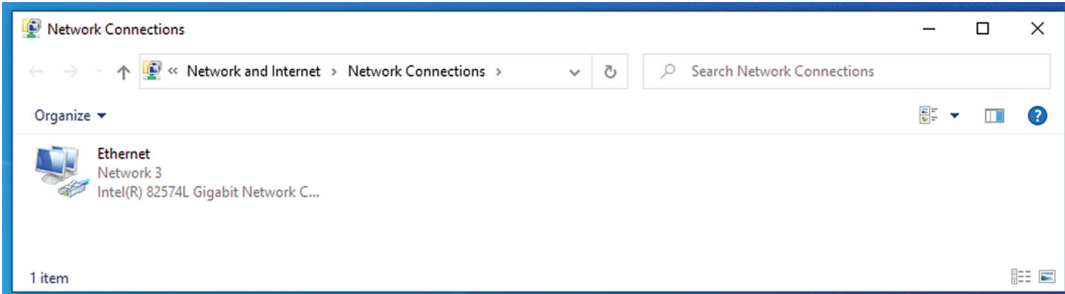

Step 3: Right click on the icon labeled Local Area Connection or Ethernet. A menu will appear. Select the option at the bottom of the menu labeled Properties. The Ethernet Properties window will appear.

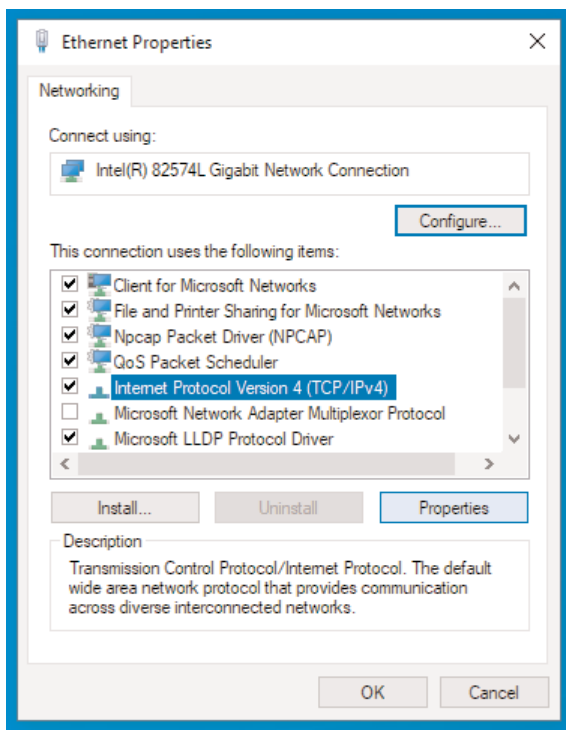

WEBSITE:
Visit our web site for product updates and additional information.

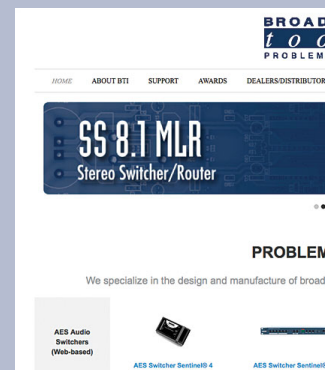

Ethernet “Quick Start” Guide

Step 4: On the Local Area Connection Properties page, double click on Internet Protocol (TCP/IPv4) to display properties.

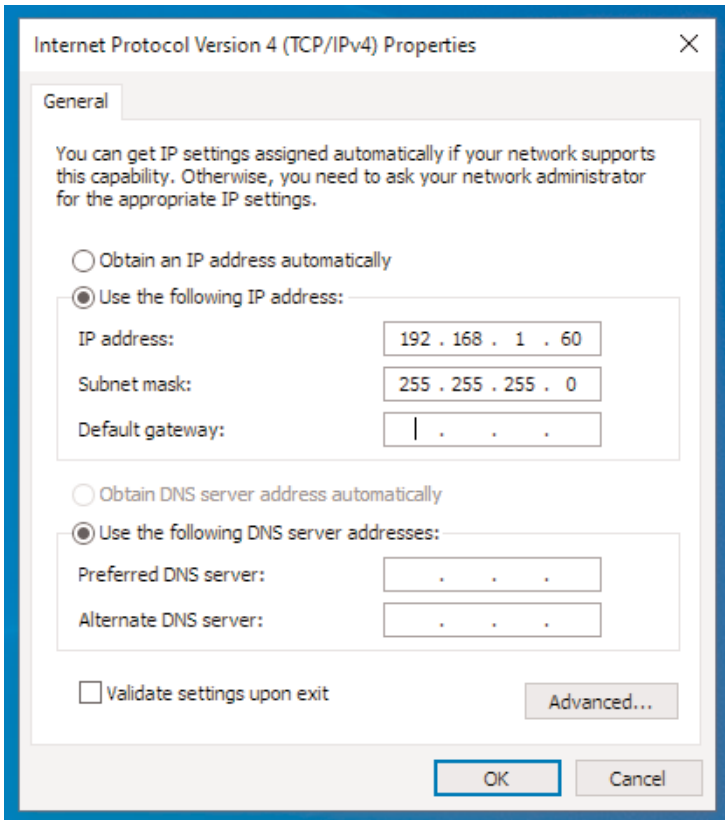

Step 5: Before making any changes to the network settings, write down the current settings (or screen capture the page and print) so that they can be restored once the unit is configured. Next, select the radio button labeled “Use the following IP address” and type in the IP address 192.168.1.60. Type in the subnet mask of 255.255.255.0. Leave the default gateway field blank. Click OK to apply the new settings.

WEBSITE:

Visit our web site for product updates and additional information.

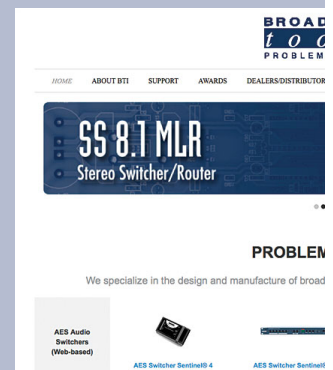

“Login” Web Page

The Login screen displays the current date/time, Site ID and username/password entry points.

BROADCAST tools AES AUDIO Sentinel[®] 4» Web Login

Date and Time 5/18/2022 09:08:15
Site ID SITE_ID

Enter Login Information:

Username

Password show password

After you have successfully logged in, the Monitor/Control page will be displayed.

WEBSITE:

Visit our web site for product updates and additional information.

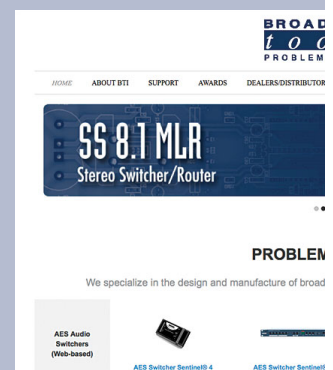

WEB SETUP

“Monitor/Control” Web Page

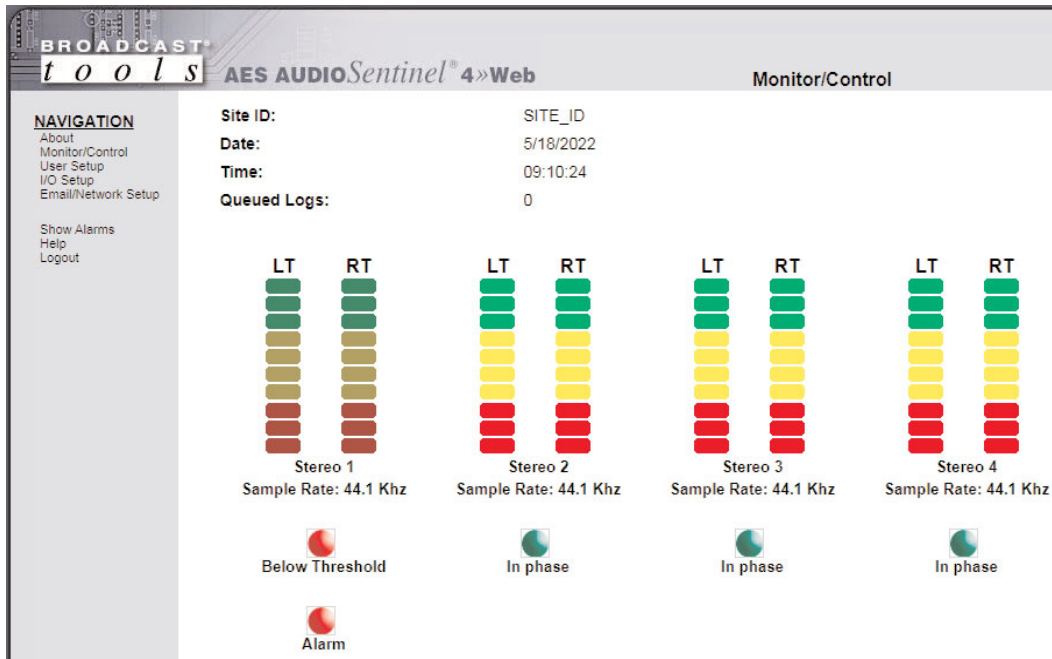

The Monitor/Control page allows the monitoring and or control of the AES Audio Sentinel 4. The following is an explanation of each item on this page:

User defined Site ID, Time and Date are always displayed.

- Queued Logs: Displays the number of queued logs.
- Input Labels: User defined in the Silence Sensor setup page
- Level Meters: Display the left and right or mono input audio levels for the inputs.
- Sample Rate: Displays input AES sample rate or Error.
- Audio/Phase indicators: When phase monitoring is enabled for a stereo input this will indicate if the audio is in phase, out of phase, or below threshold.
- Alarm indicator: Displayed when input is in an alarm state.

WEBSITE:

Visit our web site for product updates and additional information.

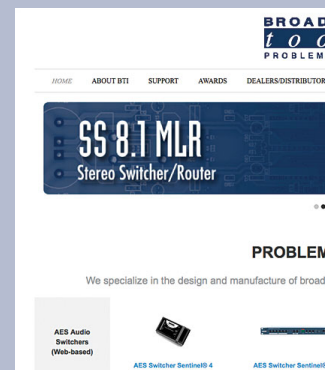

“User Setup” Web Page

Site ID	SITE_ID	Username	Password	Show Password	--- Access Level ---		
					Admin	Monitor Control	Monitor Only
		admin	****	<input type="checkbox"/>	<input checked="" type="radio"/>	<input type="radio"/>	<input type="radio"/>
				<input type="checkbox"/>	<input type="radio"/>	<input type="radio"/>	<input checked="" type="radio"/>
				<input type="checkbox"/>	<input type="radio"/>	<input type="radio"/>	<input checked="" type="radio"/>
				<input type="checkbox"/>	<input type="radio"/>	<input type="radio"/>	<input checked="" type="radio"/>
				<input type="checkbox"/>	<input type="radio"/>	<input type="radio"/>	<input checked="" type="radio"/>
				<input type="checkbox"/>	<input type="radio"/>	<input type="radio"/>	<input checked="" type="radio"/>
				<input type="checkbox"/>	<input type="radio"/>	<input type="radio"/>	<input checked="" type="radio"/>
				<input type="checkbox"/>	<input type="radio"/>	<input type="radio"/>	<input checked="" type="radio"/>

Save Settings

NOTE: You may view a password by checking the “Show Password” box.

Eight Usernames and Passwords may be configured for one of three access levels:

1. “Admin” allows complete configuration access and control.
2. “Monitor/Control” allows the following access:
About, Monitor/Control, Show log, Help, and Logout.
3. “Monitor Only” allows the following access:
About, Monitor only, Help, and Logout.

Only users with “admin” access can make changes to this page.
The site ID is displayed and can be changed on the Email/Network Setup page.

NOTE: After any item has been changed, you **MUST** press the “Save Settings” button for your changes to be saved.

WEBSITE:

Visit our web site for product updates and additional information.

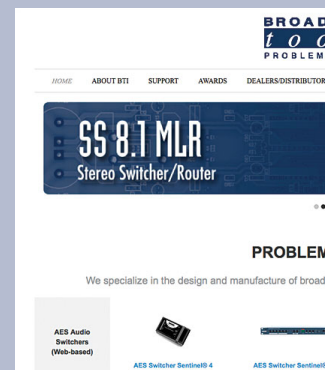

WEB SETUP

“Silence Sensor Setup” Web Page

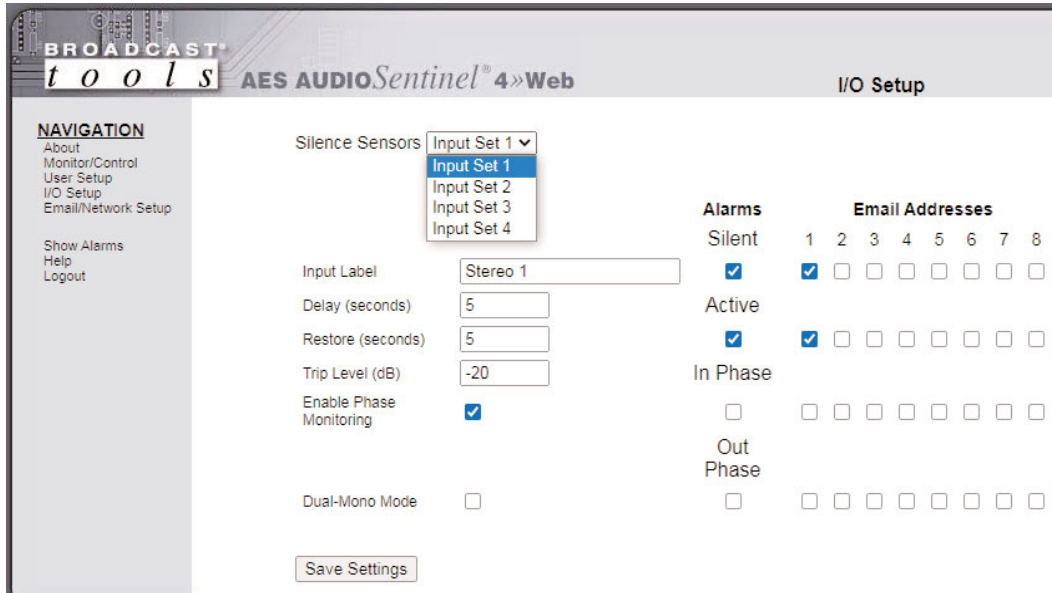

NOTE: The delay and restore timing for both channels is 0 (OFF) to 65535 seconds (18 hours, 12 minutes, and 15 seconds).

Input Label: Up to 18 characters may be entered to describe the input.

Delay (Sec): This is the time from when the left, right or both inputs

Restore Delay (Sec): This is the time required for valid stereo audio to return and remain present before the unit switches back to input ONE and clears the alarm.

Trip Level (dB): The left, right or both input levels below which input audio is considered silent/below threshold. (-12 to -36.)

Dual mono mode: When dual input mono mode is selected, the left and Right channels are monitored and labelled as separate inputs.

Input Alarms: When checked, the unit logs an alarm when the silence sensor enters or exits an alarm condition, up to eight email addresses may receive alarm emails.

Input Email Addresses: The boxes labeled 1-8 allow the user to assign up to eight

NOTE: Press the “Save Settings” button to save your changes.

WEBSITE:
Visit our web site for product updates and additional information.

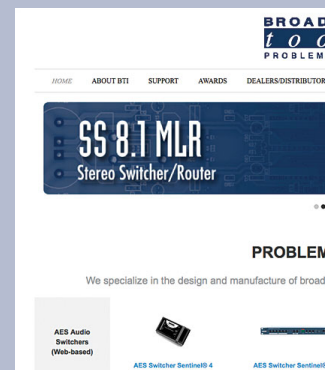

“Email/Network Setup” Web Page

BROADCAST
t o o l s
AES AUDIO Sentinel® 4» Web
Email/Network Setup

NAVIGATION

- About
- Monitor/Control
- User Setup
- IO Setup
- Email/Network Setup
- Show Alarms
- Help
- Logout

Device Address

Device Netmask

Gateway Address

DNS Server Address

HTTP Port

SMTP Server Address

SMTP Port

SMTP Return Address

SMTP Host ID

Secured SMTP (STARTTLS)

SMTP Authentication

SMTP Username

SMTP Password show password

Logging Email Address

Logging Email Snapshot Interval (Hours)

Logging Email Update Interval (Hours)

Email Alarms Immediately

Email Alarms Daily

Daily Alarm Email Time (Hour)

Recipient Addresses

1

2

3

4

5

6

7

8

SNMP Enable

SNMP Enable Traps

SNMP Trap IP Address

SNMP Read Community

SNMP Write Community

NTP Enabled

NTP Server Address

NTP Port

NTP Update Interval (Minutes)

Site ID

Monitor Refresh Time Seconds

Time Zone Offset from UTC

Enable Daylight Savings

Hour	Minute	Second
<input type="text" value="18"/>	<input type="text" value="4"/>	<input type="text" value="0"/>

Set Time

Month	Day	Year
<input type="text" value="5"/>	<input type="text" value="18"/>	<input type="text" value="2022"/>

Time is only saved when "Save Time" is clicked

Enable Event Logging

- Login
- Email
- Reboot
- Alarms Cleared

Import Settings No file chosen

Export Settings

Firmware No file chosen

WEBSITE:

Visit our web site for product updates and additional information.

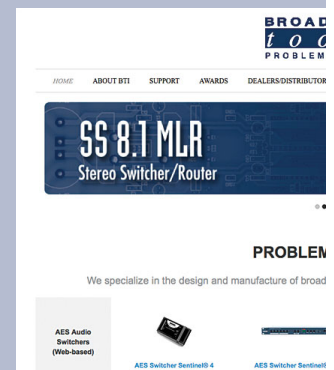

WEB SETUP

“Email/Network Setup” Web Page – Device Network Settings

Device Address: Enter a static IP address here. Default: 192.168.1.55

Device Netmask: Enter the Netmask here: Default: 255.255.255.0

Gateway Address: Enter the Gateway IP here: Default: 192.168.1.1

DNS Server IP Address: Enter your DNS address here. Default: 8.8.8.8

HTTP Port: Normally Port 80 Default: 80

“Email/Network Setup” Web Page – SMTP Settings

SMTP Server Address: SMTP (Simple Mail Transfer Protocol) server address. Used to send emails.

SMTP Port: Normally Port 25 or 587. Default: 25

SMTP Return Address: Enter your return email address here. Emails from the AES Audio Sentinel 4 will indicate they are from this address. If an email cannot be delivered, a message stating why will be sent to this address.

SMTP Host ID: Enter something here to identify the device.

Secured SMTP: STARTTLS secure authentication is supported by most providers. This must be enabled for many SMTP servers, like Gmail. Leave disabled for standard Base64 authentication.

SMTP Authentication: When checked SMTP authentication (username/password) is used. Most SMTP servers require authentication.

SMTP Username: Enter SMTP server username here.

SMTP Password: Enter SMTP server password here.

NOTE: The user must enter the following items before an email can be successfully sent: SMTP Server Address, SMTP Port, SMTP Return Address, and SMTP Host ID. SMTP username and SMTP password must be supplied, and authentication turned on if the SMTP server requires authentication. An email address must be entered into Recipient Address field #1.

The user must press the “Save Settings” button after entering the SMTP information before attempting an email test. If authentication fails, the email is not sent, please ensure that the username and password are correct.

WEBSITE:

Visit our web site for product updates and additional information.

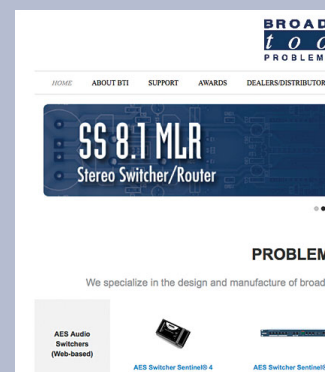

“Email/Network Setup” Web Page – Email Logging Settings

- Logging Email Address: Email address for the “Logging” email recipient (may be different from the 8 “Alarm” Recipient Addresses. Logging emails and Daily emails are sent to this address only.
- Logging Email Snapshot Interval: The period in hours that a snapshot is taken of the system. The logging email is not sent on this interval.
- Logging Email Update Interval: The period in hours that snapshots are emailed. This email may contain multiple snapshots if the Snapshot Interval is less than the Update Interval. Each snapshot will be identified by the date and time.

“Email/Network Setup” Web Page – Email Alarm Settings

- Email Alarms: Choose Immediate and/or Daily. If Immediate is selected, then an email will be sent out as soon as an alarm is generated. If Daily is selected, then each alarm is queued and emailed as a digest every 24 hours. Both can be used at the same time. The number of queued alarms is displayed on the Monitor/Control page.
- Daily Alarm Email Time: The time that queued alarms are sent. Queued alarms are sent to the Logging Email Address only.
- “Alarm” Recipient Address: Email addresses for up to 8 addresses. These addresses correlate to the 8 email addresses selectable on the I/O Setup page.

“Email/Network Setup” Web Page – SNMP Manager Settings

- SNMP Enable Traps: When checked, SNMP trap messages will be sent. When unchecked, no trap messages will be sent to the manager.
- SNMP Manager IP Address: This is the IP address of the SNMP manager. The system only accepts SNMP requests from this IP address, and will send traps to this IP address only.
- SNMP Manager Trap Port: This is the port number that SNMP trap messages will be sent to at the manager IP. Default port 161.
- SNMP Read Community: This is the community name used for Read-Only access.
- SNMP Write Community: This is the community name used for Read-Write access.

NOTE: A cold-start trap will be sent when the unit boots up if the SNMP Enable Traps are enabled and trap messages will be sent when a device enters or exits an alarm condition, if alarms are enabled.

WEBSITE:

Visit our web site for product updates and additional information.

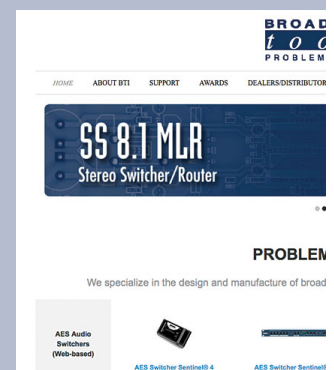

“Email/Network Setup” Web Page – NTP Settings

NTP Enabled:	Enable for NTP network time sync. Default: Enabled
NTP (Time) Server Address:	Enter the NTP address here. Default: pool.ntp.org
NTP Port:	Port used to connect to NTP server. Default: 123
NTP Update Interval (Min):	Interval between time updates. Default: 60

“Email/Network Setup” Web Page – Other Settings

Site ID:	This is the Site Identifier that is displayed on the web and in email.
Monitor Refresh Time (Sec):	Interval at which the Monitor page refreshes. Shorter times may increase network traffic.
Time Zone Offset from UTC:	Sets the time zone used for the internal clock. Default: -8
Enable Daylight Savings:	Adjusts the clock for daylight savings time.
Set Time:	The hour, minute, second, month, day and year boxes can be used to set the time of the real time clock. The time is only updated if you click “Save Time” and not when you “Save Settings”.
Enable Event Logging:	Event logging will generate an alarm, but it will not send an email. If the system is configured for Daily Alarm emails, then that Daily Alarm email will contain the event logging alarms as well as the alarms configured on the I/O Setup page.
Login:	When someone logs into the unit, the username and date/time will be logged.
Email:	When an email is sent, the type of email and date/time will be logged.
Reboot:	When the device boots the date/time will be logged.
Alarms Cleared:	When the Daily Logs or Normal Alarms are cleared, the type of log cleared and date/time will be stored. When Daily Logs are sent, the Daily Logs are also cleared; this will cause an event log as well.

WEBSITE:

Visit our web site for product updates and additional information.

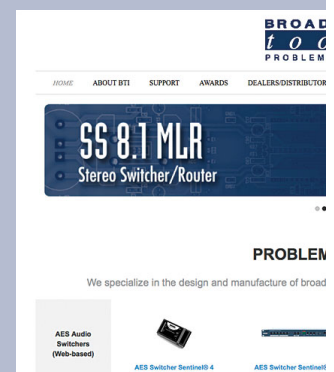

“Email/Network Setup” Web Page – Controls

Save Settings: After pressing the “Save Settings” button, the device will reboot (If you changed the IP address, you must navigate your web browser to the new IP address (if the HTTP port was changed from port 80, be sure to add the new port number after the IP: xxx.xxx.xxx.xxx:port #). If you didn’t change the IP address, then you will be returned to the login screen after the device reboots.

Reboot Device: When you press the “Reboot Device” button, the internal web server restarts.

Send Test Email: Press this button to send a test email to recipient address #1.

NOTE: After you are done making changes to the Email/Network Setup page, you MUST press the “Save Settings” button to save your changes.

Reload Defaults: When you press the “Reload Defaults” button, the device resets to factory default settings.

Clear Daily Logs: When you press the “Clear Daily Logs” button, the daily logs stored in memory will be cleared. Keep in mind that if the Alarms Cleared Event is enabled, this event will post after the logs are cleared.

Send Daily Logs: When you press the “Send Daily Logs” button, the system will send the daily logs email and clear the log queue.

Import Settings: Browse to locate and import a .ncs saved settings file.

Export Settings: Clicking save will allow you to download a backup copy of the settings entered into the unit as .ncs file.

Firmware: Browse to locate and apply a firmware updated file saved on your computer.

WEBSITE:

Visit our web site for product updates and additional information.

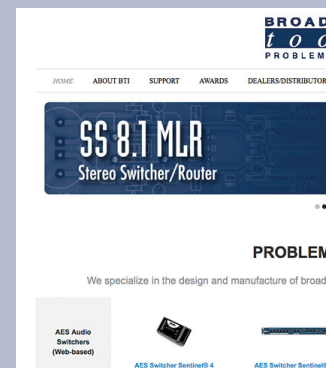

“Show Log” Web Page

Device/Event	Message	Date/Time
Stereo 1	In Alarm	6/1/2022 07:23:28
Stereo 1	Sample Error	6/1/2022 07:23:58
Stereo 1	Sample Rate 44.1K	6/1/2022 07:27:14
Stereo 1	Active	6/1/2022 07:27:38

Last Updated 6/1/2022 08:03:59

This page displays current alarms.

Alarm Messages

- Active: Audio above silence alarm threshold.
- In Alarm: Audio below silence alarm threshold
- In Phase: Stereo input exited out of phase alarm.
- Out of Phase: Stereo input entered out of phase alarm.
- Sample Rate: AES Signal Present at Sample Rate
- Sample Error: AES Signal Lost or Invalid

Controls

- Disable Sound: Mutes the alarm sound.
- Silence Alarms: Marks active alarms as acknowledged.
- Clear Alarms: Empties the Alarm Log.

NOTE: With the “admin” access level, the user may control all functions.

With the “Monitor/Control” or “Monitor” only access level, the user may view the “Show Log”, enable/disable PC speaker sound and silence alarms.

WEBSITE:

Visit our web site for product updates and additional information.

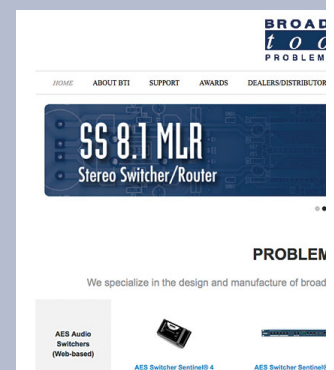

WEB SETUP

“About” Web Page

Broadcast Tools, Inc.	
Device Name	AES Audio Sentinel 4
Firmware Version	0.05
Web page Version	0.03
Home page	www.BroadcastTools.com

The “About” web page displays the product name, firmware version numbers, and Broadcast Tools® web site link.

WEBSITE:

Visit our web site for product updates and additional information.

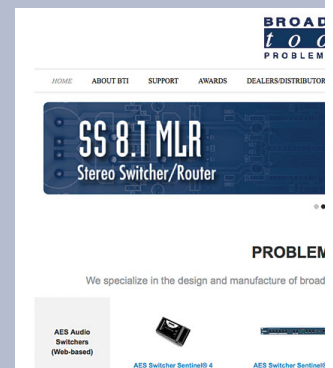

WEB SETUP

Specifications

Ethernet Interface:	RJ-45, 10base-T or 100base-TX, auto sensing with link & activity LED indicators - Full/half duplex.
Supported Protocols:	TCP/IP, UDP/IP, ARP, ICMP, SNMP, HTTP, ESMTTP, SMTPS.
Inputs:	(4) AES/EBU digital audio inputs. XLR-F jacks.
Silence Sense Level:	-12 to -36 dB below normal level, adjustable in 1dB steps.
Alarm Delay, Restore Delay Time:	0 (OFF) to 65535 seconds (18 hours, 12 minutes and 15 seconds).
Open Collector outputs:	Eight (8) alarm outputs. Each output sinks up to 6 VDC @ 100 mA (max.) Removable euro-block screw terminals, mating plugs supplied.

NOTE: PCB Revision A and higher: the open collector voltage limit can be increased to 12 VDC by moving the JP10 jumper from the “5V” position to the “VIN” position.

Required power supply:	12 VDC surge protected universal switching power supply with IEC inlet and domestic AC cable included. 500 mA minimum output. 2.1mm ID x 5.5mm OD coaxial connector, center positive
Physical Dimensions:	8.50" x 7.10" x 1.576" (WDH) aluminum extrusion chassis with (4) #6-32 screw thread mounting holes for optional RA-1 rack shelf
Weight:	3.0 lb.
Shipping Weight:	4.0 lb.
Accessories:	RA-1, 1-RU rack shelf. Accommodates 2 units.

WEBSITE:

Visit our web site for product updates and additional information.

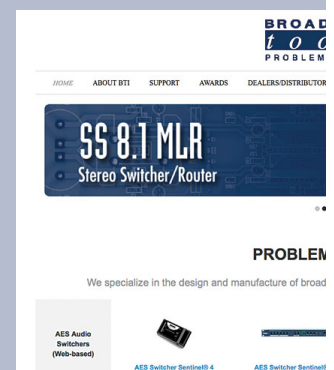

LIMITED WARRANTY

The term "Buyer" as used in this document refers to and includes both (but only) (a) any person or entity who acquires such an item for the purpose of resale to others (i.e., a dealer or distributor of an item), and (b) the first person or entity who acquires such an item for such person's or entity's own use.

Broadcast Tools warrants to each Buyer of any item manufactured by Broadcast Tools that the item will be free from defects in materials and workmanship at the time it is shipped by Broadcast Tools if the item is properly installed, used and maintained.

EXCLUSIVE REMEDIES

If Broadcast Tools is notified, in writing, of a failure of any item manufactured by Broadcast Tools to conform to the foregoing Limited Warranty within one (1) year following the date of the Buyer's acquisition of the item, and if the item is returned to Broadcast Tools in accordance with Broadcast Tools' instructions for confirmation by inspection of the defect (which at Broadcast Tools' election may include, without limitation, a requirement that the Buyer first obtain a Return Authorization number from Broadcast Tools, that the Buyer furnish proof of purchase in the form of an invoice and/or receipt, and that the Buyer prepay all freight charges associated with any return of the item to Broadcast Tools using such freight service as Broadcast Tools reasonably may specify), Broadcast Tools will repair or replace the defective item, or will refund the purchase price paid by the Buyer for the item. Broadcast Tools shall have the exclusive right to choose between these alternative remedies.

NO OTHER WARRANTIES OR REMEDIES

TO THE MAXIMUM EXTENT PERMITTED BY APPLICABLE LAW, BROADCAST TOOLS AND ITS SUPPLIERS DISCLAIM ALL OTHER WARRANTIES, EITHER EXPRESS OR IMPLIED, INCLUDING BUT NOT LIMITED TO IMPLIED WARRANTIES OF MERCHANTABILITY OR FITNESS FOR A PARTICULAR PURPOSE; AND THE FOREGOING ALTERNATIVE REMEDIES SHALL BE EXCLUSIVE OF ALL OTHER REMEDIES. THIS LIMITED WARRANTY GIVES YOU SPECIFIC LEGAL RIGHTS. YOU MAY HAVE OTHER RIGHTS, WHICH VARY FROM STATE/JURISDICTION TO STATE/JURISDICTION.

NO LIABILITY FOR CONSEQUENTIAL DAMAGES

TO THE MAXIMUM EXTENT PERMITTED BY APPLICABLE LAW, NEITHER BROADCAST TOOLS NOR ANY OF ITS SUPPLIERS SHALL HAVE ANY LIABILITY FOR ANY SPECIAL, INCIDENTAL, INDIRECT, CONSEQUENTIAL OR PUNITIVE DAMAGES WHATSOEVER (INCLUDING, WITHOUT LIMITATION, ANY DAMAGES FOR LOST PROFITS, BUSINESS INTERRUPTION, LOSS OF DATA OR INFORMATION, COST OF CAPITAL, CLAIMS OF CUSTOMERS, OR ANY OTHER PECUNIARY LOSS) ARISING OUT OF THE USE OF OR THE INABILITY TO USE ANY ITEM SUPPLIED BY BROADCAST TOOLS, EVEN IF BROADCAST TOOLS HAS BEEN ADVISED OF THE POSSIBILITY OF SUCH DAMAGES HAVE ANY LIABILITY FOR ANY SPECIAL, INCIDENTAL, CONSEQUENTIAL, EXEMPLARY OR PUNITIVE DAMAGES. THIS LIMITATION OF LIABILITY APPLIES WHETHER A CLAIM IS ONE ALLEGING BREACH OF A CONTRACT OR WARRANTY, NEGLIGENCE OR OTHER TORT, FOR THE VIOLATION OF ANY STATUTORY DUTY, THE FAILURE OF ANY LIMITED OR EXCLUSIVE REMEDY TO ACHIEVE ITS ESSENTIAL PURPOSE, OR ANY OTHER CLAIM OF ANY NATURE. BECAUSE SOME STATES AND JURISDICTIONS DO NOT ALLOW THE EXCLUSION OR LIMITATION OF LIABILITY FOR INCIDENTAL OR CONSEQUENTIAL DAMAGES, THIS LIMITATION MAY NOT APPLY TO YOU.

Broadcast Tools, Inc.

131 State Street
Sedro-Woolley, WA 98284 • USA

360.854.9559 **voice** • 866.783.1742 **fax**
support@broadcasttools.com **e-mail**
www.broadcasttools.com **website**

Component Layout

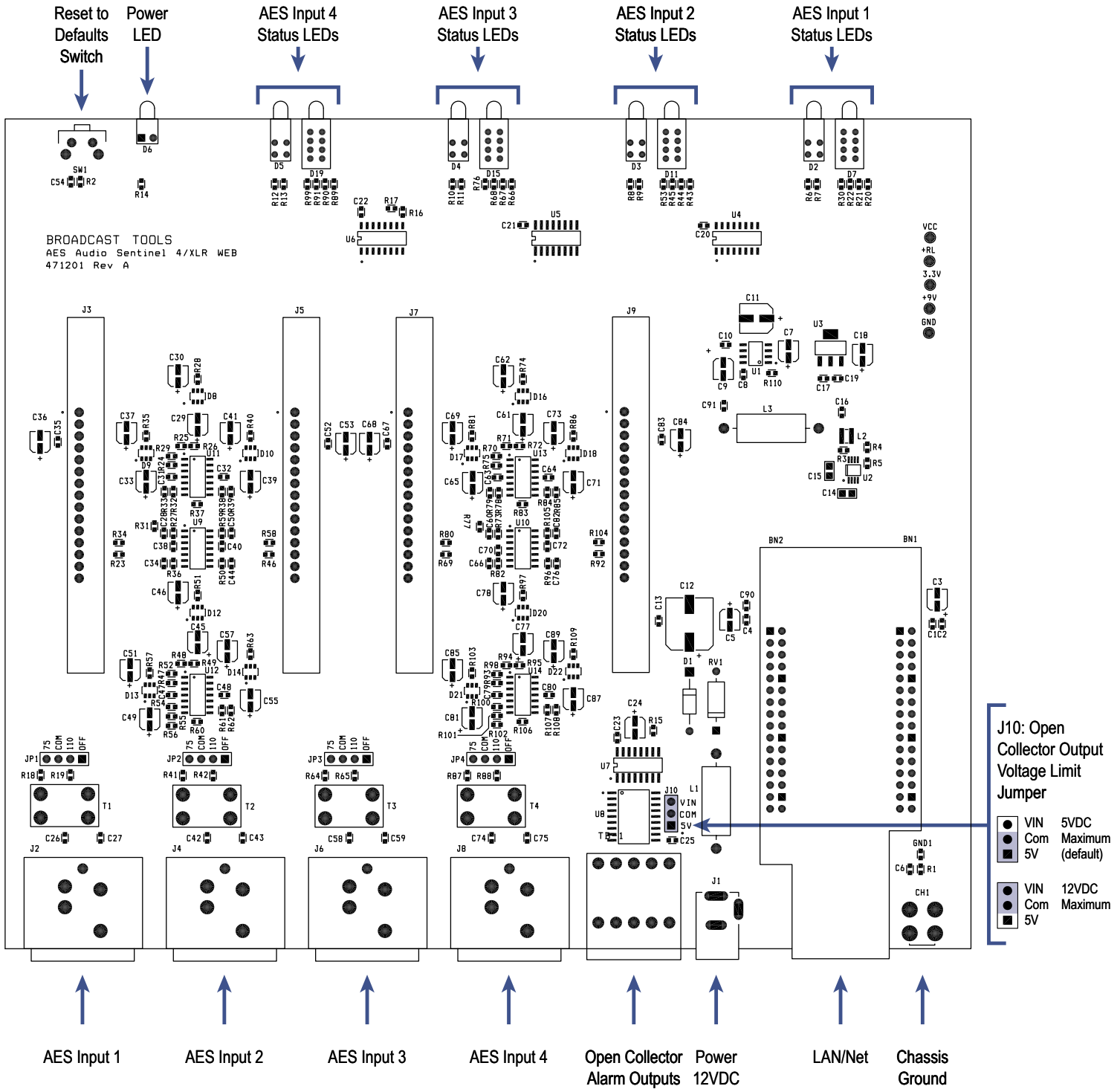

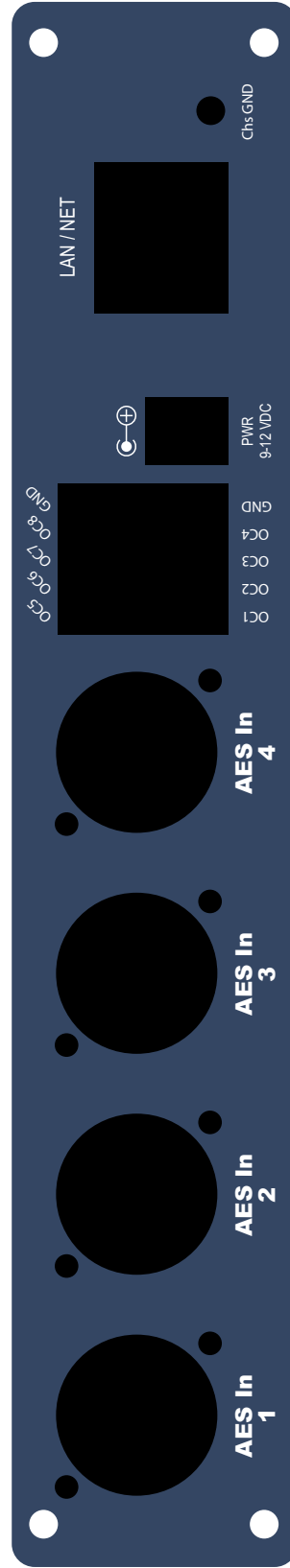

Functional Diagram

