

BROADCAST[®]
t o o l s **INC**[®]
PROBLEM SOLVED

Installation and Operation Manual



SS 4.1 MLR/RJ ***RJ45 Audio Switcher/Router with Mechanical Latching Relays***

Manual update: 6/8/2020

If you need a firmware upgrade, contact Broadcast Tools[®]

No part of this document may be reproduced or distributed without permission.
ALL SPECIFICATIONS AND FEATURES FOR THIS PRODUCT ARE SUBJECT TO
CHANGE WITHOUT NOTICE

NOTE: We recommend the use of Chrome, Firefox or Safari as your browser.

Due to the dynamic nature of product design, the information contained in this document is subject to change without notice. Broadcast Tools, Inc., assumes no responsibility for errors and/or omissions contained in this document. Revisions of this information or new editions may be issued to incorporate such changes.

*Broadcast Tools[®] is a registered trademark of Broadcast Tools, Inc.
All Sentinel[®] labeled products are registered trademarks of Broadcast Tools, Inc.
Copyright[®] 1989 - 2020 by Broadcast Tools, Inc. All rights reserved.
No part of this document may be reproduced or distributed without permission.*

Visit www.broadcasttools.com for important product update information.

Table of Contents

Section Title	Page #
Introduction	3
Safety Information	3
Who to Contact for Help	3
Product Overview	4
Features/Benefits	4
Applications	4
Inspection	5
Installation	5
Surge Protection	5
UPS standby power system	5
Installation/Operation	5
Input selection push buttons	5
LED indicators	5
Power	5
I/O Connections	6
Audio Inputs and Output	6
PIP (GPI)/Remote Control Inputs	7
Open Collector Outputs	8
Configuration jumper setup	9
Configuration Dip-switch setup	9
Serial Operation	10
RS-232 Control	10
Serial commands	11
Menu Operation	12
Specifications	13
Warranty	14
Front and rear panel drawings	Appendix
Configuration jumpers and DIP-switch layout	Appendix
Fractional schematic	Appendix

WEBSITE:
Visit our web site for product updates and additional information.

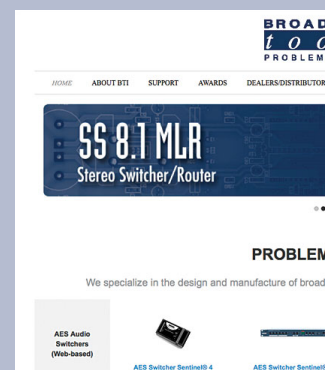

INTRODUCTION

Thank you for your purchase of a Broadcast Tools® SS 4.1 MLR/RJ transparent four input, one output switcher/router (referred to as the SS 4.1 MLR/RJ throughout this manual). We're confident that this product will give you many years of dependable service. This manual is intended to give you all the information needed to install and operate the Broadcast Tools® SS 4.1 MLR/RJ.

SAFETY INFORMATION

Only qualified technical personnel should install the SS 4.1 MLR/RJ. Any attempt to install this device by a person who is not technically qualified could result in a hazardous condition to the installer or other personnel or damage to the SS 4.1 MLR/RJ or other equipment. Please ensure that proper safety precautions have been taken before installing this device. If you are unfamiliar with this type of equipment, please contact a properly qualified engineer to handle the installation and setup of the SS 4.1 MLR/RJ. Broadcast Tools, Inc., is unable to support NON-Broadcast Tools software, hardware or NON-Broadcast Tools computer/hardware/software problems. If you experience these problems, please research your hardware/software instruction manuals or contact the manufacturers technical support department.

WHO TO CONTACT FOR HELP

If you have any questions regarding your product or you need assistance, please contact your distributor from whom you purchased this equipment. If you would like more information about BROADCAST TOOLS® products, you may reach us at:

Broadcast Tools, Inc.

131 State Street
Sedro-Woolley, WA 98284-1503 USA
Voice: 360.854.9559
Fax: 866.783.1742

Internet Home Page: www.broadcasttools.com
E-mail: support@broadcasttools.com

**THANK YOU FOR CHOOSING
BROADCAST TOOLS® BRAND PRODUCTS!**

Broadcast Tools is a Veteran Owned Business



Designed, Assembled and Supported in WA State, USA



CAUTION!

Broadcast Tools® Products, as with any electronic device, can fail without warning. Do not use this product in applications where a life threatening condition could result due to failure.



NOTE:

This manual should be read thoroughly before installation and operation.

WEBSITE:

Visit our web site for product updates and additional information.

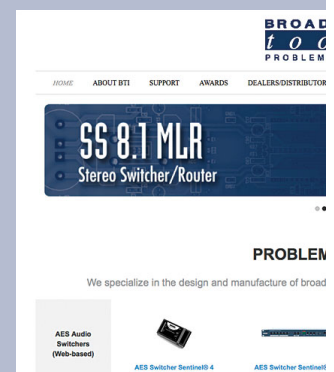

Product Overview

The SS 4.1 MLR/RJ is a transparent four input, one output RJ45 audio switcher/router with mechanical latching relays. The SS 4.1 MLR/RJ is perfect for all types of passive signal switching via front panel switches, contact closures and/or serial RS-232. The switching is accomplished with mechanical latching gold contact relays, which means that the unit can route a signal in either direction and it will keep routing signal even after losing power. Due to the passive nature of the switching, any input level and impedance can be used. Inputs may be balanced or unbalanced, while output levels, impedance, distortion, noise, and balancing will match that of the selected input. The SS 4.1 MLR/RJ can be controlled and monitored locally and/or with simple contact closures to ground, as well with multi-drop RS-232 serial commands.

Features/Benefits

- Front panel input channel selection push buttons with active channel LED indicators.
- Front panel “Mute” switch, with LED indicator, to turn off all audio to the output.
- Front panel “Enable” switch, with LED indicator, can be configured to provide a safety lock to the front panel selection push buttons.
- Audio/signal switching via mechanical latching sealed relays utilizing 2-form-C bifurcated - crossbar silver alloy with gold overlay contacts.
- Four shielded RJ45 audio input jacks and one shielded RJ45 audio output jack.
- Removable euro-block screw terminal connectors are used for remote control connections. Necessary mating plugs are supplied.
- Internal silence sensor with front panel LED indicator, SPST silence sensor alarm relay, and adjustable alarm delay and restore duration.
- Eight input GPI port (PIP or Remote Control) with LED indicator.
- Remote control via contact closures, 5-volt TTL/CMOS logic levels and/or the multi-drop RS-232 serial port.
- Four open collector outputs for remote channel status.
- Power-up selection of inputs to outputs, mute or last source selected.
- If power is lost, the last selected channel is passed to the output.
- Fully RFI proofed.
- Surge protected internal power supply, universal switching power supply with domestic connector supplied. International power supply optional.
- Up to three units may be mounted on the optional RA-1 rack shelf. Desktop and wall mounting is also possible.

Applications

Automation source switching with eight PIP/trigger inputs; Studio selection and routing; Audio processing selection; Exciter input selection; Remote broadcast input selection; STL source selection; Multiple station program on-hold and/or PA switching; EAS audio switching; ISDN or Phone hybrid feed selection; IFB selection; Satellite audio channel switching and console monitor input and output selection.

WEBSITE:

Visit our web site for product updates and additional information.

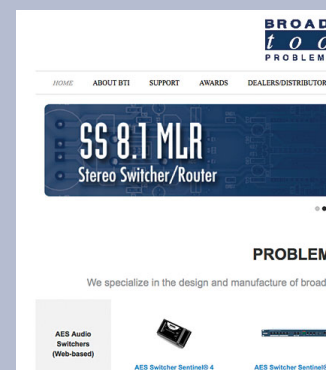

Inspection

Please examine your SS 4.1 MLR/RJ carefully for any damage that may have been sustained during shipping. If any damage is present, please notify the shipper immediately and retain the packaging for inspection by the shipper. The package should contain the SS 4.1 MLR/RJ, a modular cable with 9-pin “S9” female D-sub adapter, and a 7.5 to 12 VDC wall transformer. Manuals may be downloaded from our web site.

Installation

Surge Protection

The SS 4.1 MLR/RJ has built-in resistance to voltage changes; we recommend that you use a power surge protector or line conditioner on the incoming AC line. Lightning strikes and/or other high voltage surges may damage your SS 4.1 MLR/RJ and connected equipment if it is not properly protected. For lightning protection devices, check out www.polyphaser.com and www.itwlinx.com.

UPS Standby Power System

We recommend that you connect your SS 4.1 MLR/RJ to a UPS system. A UPS helps minimize the risk to the SS 4.1 MLR/RJ and provides power during a power outage.

NOTE: If power is lost, the last selected channel is passed to the output.

Installation/Operation

Input, Mute and Enable push buttons

Each of the four audio inputs and mute can be selected via its front panel push button labelled “1”, “2”, “3”, “4”, and “Mute” respectively. Each input push button has an associated LED indicator which will illuminate when the channel is selected. When an input channel is selected, the previous channel is deselected (interlock). The “Enable” (safety) push button can be enabled to require the user to hold down the enable push button while selecting any of the other front panel push buttons, the enable LED is illuminated when this function is enabled, see page 9 for more information.

LED indicators

- “PWR” LED: Illuminates when power is applied and blinks when serial data is active.
- “PIP” LED: Flashes to indicate PIP/trigger activity.
- “SS”: Silence Sensor indicator LED, lit when silence is detected (if enabled.)
- “Enable” LED: Illuminates when the front panel enable push button option is enabled.
- Channel (“1-4”) and “Mute” LEDs: illuminate when the channel on or Mute is selected.

Power

Connect the 2.1mm barrel type center positive power connector into the unit and the 7.5 to 12 VDC power supply with domestic connector into a 120 Vac 50-60 Hz power source. Never use any type of power supply other than the specified/supplied power supply.

Chassis Ground screw (CHS GND): The #6-32 sized chassis ground screw should be tied to the station (house) or system ground.

WEBSITE:

Visit our web site for product updates and additional information.

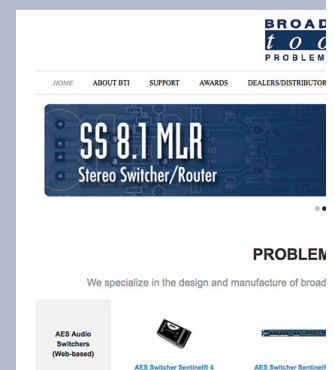

INSTALLATION

I/O Connections

The rear panel contains all the input, output, and remote control connectors. The multi-drop serial port is equipped with a modular RJ-11 jack and an “S9” modular to DB9 adapter/cable.

RJ45 Audio Inputs and Output

Input 1 RJ45	Input 3 RJ45	
Input 2 RJ45	Input 4 RJ45	Output RJ45

Input sources that are NOT selected are terminated with a 10K ohm resistor. If you do not require this load applied to the deselected sources, they may be removed from each channel. Each channel has a pair of resistors: channel 1 L & R = R30 & R31, channel 2 L & R = R32 & R33, channel 3 L & R, R34 & R35 and channel 4 L & R = R36 & R37.

If you are using the SS 4.1 MLR/RJ applications other than switching analog audio, the output Silence Sensor and ACT audio detection circuit should be disabled. To disable, remove the 1K ohm resistor network RP2 from its socket.

RJ45 Audio Cables

Please use shielded twisted pair Cat5e or Cat6 cables and connectors (STP) with the input and output RJ45 audio jacks.

RJ45 Audio Cat5 Pinout:

Function:	Wire Pair:	RJ45 Pins:
Left+/AES+	White/Orange	1
Left-/AES-	Orange/White	2
Right+	White/Green	3
Right -	Green/White	6
n/c	White/Blue	5
DC GND	Blue/White	4
n/c	White/Brown	7
n/c	Brown/White	8
Sig. Shield	Shield	Connector Shield

WEBSITE:

Visit our web site for product updates and additional information.

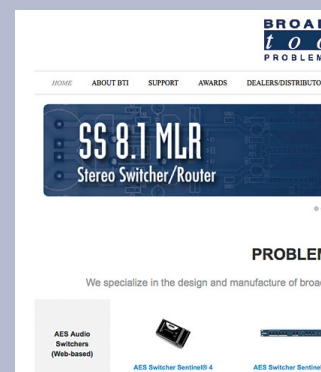

PIP Trigger/Remote Control Inputs

The SS 4.1 MLR/RJ interfaces to external equipment through removable euro-block screw terminals. The terminals accommodate wire sizes from 16 - 28 AWG solid or stranded wire. Before installing a wire, remove the euro-block screw terminal plug and turn each capture screw fully counterclockwise. Strip each conductor to a length of 0.25" and insert the conductor fully into the terminal. Turn the capture screw fully clockwise to secure the conductor.

The SS 4.1 MLR/RJ has eight status inputs that may be configured for PIP ("triggers") or remote control operation and accept momentary contact closures (or sustained, if break before make); open collector or TTL/CMOS input logic levels.

(Top row, TB3)
See Below

							GND
PIP1 (IN-1)	PIP2 (IN-2)	PIP3 (IN-3)	PIP4 (IN-4)	PIP5 (Mute)	PIP6 (Step)	PIP7	PIP8 (EAS)

PIP/Remote Control Inputs

(Bottom Row, TB3)

The PIP/remote control operation mode is set by the SW9-7 DIP-switch, when SW9-7 is OFF the unit is in remote control mode and when SW9-7 is ON the unit is in PIP mode. The PIP/remote control connections to the switcher are found on the bottom row of the connector TB3. Each channel may be selected by a momentary contact to ground. Each channel is pulled high (5-volts) through a 22K resistor.

In remote control mode the inputs are triggered by momentary closure to (pulse) to ground (low.) For example, pulsing the "MUTE" input to ground would turn off the output of the SS 4.1 MLR/RJ until a front panel source switch is pressed, a different remote control input is activated, the unit is powered up and/or a serial command is received from a PC or other serial device.

Pulsing the "STEP" input to ground will step the unit one source for each low to high transition on this input. Automatic timed sequencing may be accomplished by holding the step input low. The unit will now step to each source at a user programmable rate from 1 to 99 seconds (10 seconds by default). The last step channel is user programmable and is set to 4 by default. This feature may be used to sequence through multiple station air monitor signals for a program on-hold feed.

The SS 4.1 MLR/RJ is also capable of being used for EAS audio insertion via contact closure. This feature is enabled by setting the EAS controlled input channel via RS232 to the desired audio input channel (see the Serial Operation section of this manual for more information.) Once an input channel has been designated the SS 4.1 MLR/RJ will automatically switch to that input for the duration of a sustained closure to ground on the "PIP8/EAS" remote control input. When an EAS controlled input channel is configured PIP8 is not used for PIP triggers.

WEBSITE:

Visit our web site for product updates and additional information.

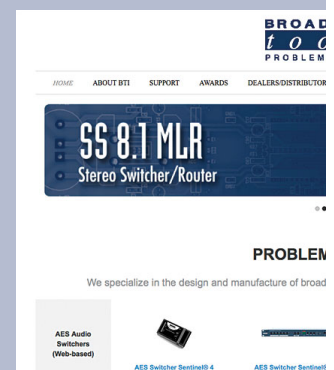

Open Collector and Silence Sense Relay Outputs

The SS 4.1 MLR/RJ has four open collector outputs that are used to indicate channel selection status. OC1 indicates for Input 1, OC2 indicates for Input 2, etc. The status open collector (OCx) output for the selected channel will go low to ground (GND) providing a return for an LED indicator, TTL/CMOS logic or relay. External pull-up resistors may be required in some installations. In addition to the open collector outputs located on TB3, the SPDT silence sense alarm relay contacts are also present, labeled SS-NC (normally closed), SS-NO (normally open) and SS-CM (common.)

(Top row, TB3)

Open Collector/Silence Sense Relay Outputs

OC1	OC2	OC3	OC4	SSNC	SSNO	SSCM	GND
-----	-----	-----	-----	------	------	------	-----

See Above
(Bottom Row, TB3)

RS-232 Serial Port (RJ-11 Jack):

This RJ-11 jack is used to connect the SS 4.1 MLR/RJ to a computer's COM port for RS-232 serial operation using the included reverse modular cable with 9-pin "S9" female D-sub adapter. If your PC does not have a built-in RS-232 serial port but does have USB, then a USB-to-serial adapter cable is a good way to add serial capability. We recommend USB-to-serial adapter cables that use the FTDI chipset and have had good results with the model "SBT-FTDI" from Sabrent.



CAUTION!

Installation of the SS 4.1 MLR/RJ in high RF environments should be performed with care. The station ground should be connected to the designated chassis ground terminal using a 20 to 24-gauge wire.



NOTE:

For wiring information, refer to the grids in this section of the manual, the silk-screen text on the rear panel of the product or the fractional schematic in the appendix.

WEBSITE:

Visit our web site for product updates and additional information.

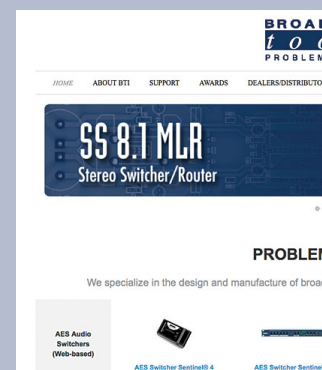

Configuration Jumpers

JP4: Disabled = Front panel enable switch defeated. (Factory default)

Enabled = Front panel ENABLE push button active and the enable LED is illuminated.

NOTE: The enable push button must be held in/closed to operate any of the other front panel push buttons and isn't associated with any of the remote control functions.

Configuration DIP-switch Setup

Follow the tables below for SW9 dip-switch configuration options.

Unit ID	SW9-1	SW9-2	SW9-3
ID 0 *	OFF	OFF	OFF
ID 1	ON	OFF	OFF
ID 2	OFF	ON	OFF
ID 3	ON	ON	OFF
ID 4	OFF	OFF	ON
ID 5	ON	OFF	ON
ID 6	OFF	ON	ON
ID 7	ON	ON	ON

Baud Rate	SW9-4	SW9-5
2400	ON	OFF
9600 *	OFF	OFF
19200	OFF	ON
38400	ON	ON

Power Up	SW9-6
User selected	ON
Last source selected *	OFF

Note: To select an input at power-up with SW9-6 ON, hold down the push-button for the desired input channel or mute until the front panel LEDs flash.

Operation Mode	SW9-7
Remote Control *	OFF
PIP/Triggers	ON

- Remote control operation mode: Pulse 1-IN to select channel 1, pulse IN-2 to select channel 2, pulse IN-3 to select channel 3, pulse IN-4 to select input 4, pulse the "M-IN" (mute) pin to turn off all channels.
- PIP/Trigger mode: activity on any of the PIP inputs will generate a serial status string in the PIP format. For use with automation software.

Note: After changing any DIP-switch, please repower the unit.

Note: * Denotes factory default setting.

WEBSITE:

Visit our web site for product updates and additional information.

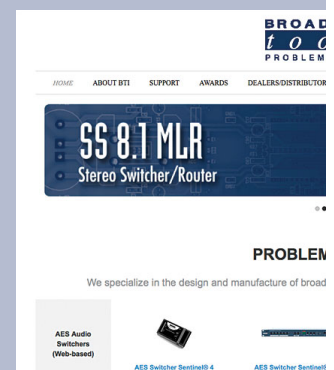

SERIAL OPERATION

RS-232 Serial Control

Connect one end of the modular cable to the RJ11 jack on the rear panel of the product and the other end to the RJ11 to the jack on the “S9” 9-pin female D-sub adapter. Connect the 9-pin female D-sub “S9” adapter to the COM port of the controlling PC. The default protocol is as follows: 9600, N, 8, 1 (other baud rates are user selectable). Select the desired unit ID address for each unit using the configuration DIP-switches, zero is the factory default setting. Never duplicate addresses.

Note: If your PC does not have a built-in RS-232 serial port but does have USB, then a USB-to-serial adapter cable is a good way to add serial capability. We recommend USB-to-serial adapter cables that use the FTDI chipset and have had good results with the model “SBT-FTDI” from Sabrent.

RJ-11 Adapter Pin	DB-9 D-SUB Pin #	Product's point of view Function Name.
4	3	RS-232 Receive
3	2	RS-232 Transmit
2	5	Ground

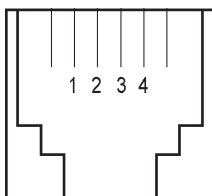

Modular Jack Pin Numbers



CAUTION!

Broadcast Tools products, as any electronic device, can fail ...



NOTE:

For safety, **DO NOT** connect ...



TIP

Helpful tips area.

WEBSITE:

Visit our web site for product updates and additional information.

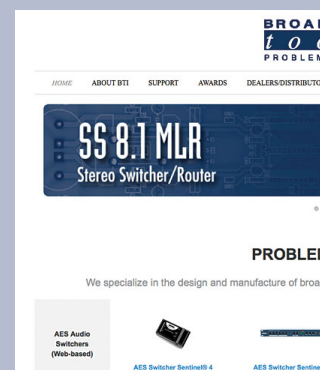

Serial Commands

The switcher may be controlled and monitored by burst serial strings or by the embedded menu.

Where the

- < * > Denotes start of string character
- < u > Unit ID (address, 0 through 7)
- < ii > Input channel (01, 02, 03, or 04).
- < o > Output channel (1)

- *u*ii* - Switch to input *ii*
- *uMA - Mute output
- *0MM - Go to setup menu, see menu operation section of the manual for more information. Unit ID 0 only.

(NOTE: The setup menu times out after 60 seconds of keyboard inactivity).

Examples: *004 This string would turn on channel 4 for a switcher set to unit ID 0.
*0MM Accesses the setup menu.

- *POLL Returns unit ID address in appropriate time slot.
- *uSL Sends audio status for all inputs: SuLo,x,x,x,x<CR><LF>
- *uSP*ii* Sends PIP status for input *ii*: SuP,*ii*,x
- *uSPA Sends PIP status for all inputs: SuP,A,x,x,x,x<CR><LF>
- *uSS Sends status of silence sensor: SuS,a<CR><LF>
a = 1 = not silent, 0 is silent
- *uU Sends unit firmware version: <name><version><lf>
- *uY Display configuration.
- *uZx Echo character x to serial control port - for debugging command strings
- *uCEx Enable error and good responses if x = Y (default N)
- *uCDEF Reset to factory defaults.
- *uCLx Lock front panel: x = L (Lock) x = U (Unlock)
- *uCI*ttt* Sets PIP minimum pulse length *ttt*: 000 - 255 => off to 2.55 seconds.
- *uCPS Power up audio state: save power up state now
- *uCSLx Sets silence sensor detection threshold to Off, -20, -25, -30 dB (0,1,2,3)
- *uCSA*ttt* Sets silence sensor acquire delay to *ttt* seconds (0, 2-255)
- *uCSB*ttt* Sets silence sensor restore delay to *ttt* seconds (0, 2-255)
- *uCSC*tt* Sets step interval in seconds 1-99 seconds.
- *uCSSt Sets last step channel 1-4 (0 disables step feature.)
- *uCSEi Sets EAS controlled input channel (*i*) to 1-4 or 0 for off. This allows you to assign one input channel that will be switched to with sustained closure to ground on the PIP8/EAS remote control input from an EAS encoder for EAS audio insertion with the SS 4.1 MLR/RJ.
- *uDxx Delay xx seconds before processing next command.
- *uDLxxx Delay xxx seconds before processing next command.

WEBSITE:

Visit our web site for product updates and additional information.

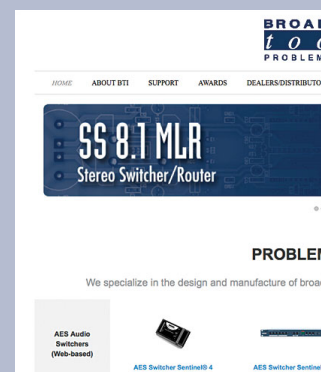

Menu Operation

Broadcast Tools(R) SS 4.1 MLR, v1.15 - Setup Menu

- 1 - Set PIP Minimum Hold Time(0 - 2.55 sec) - Now:0.05
- 2 - Set Silence Sense Acquire Delay (sec) - Now: 10
- 3 - Set Silence Sense Restore Delay (sec) - Now: 2
- 4 - Set Silence Sense Threshold - Now:OFF
- 5 - Set Stepping Interval (sec 1-99) - Now: 10
- 6 - Set Last Step Channel - Now: 4
- 7 - Lock/Unlock Front Panel - Now:UNLOCKED
- 8 - Set EAS Controlled Input - Now: Off

S - Turn ON audio input

M - Turn OFF audio

V - Save Audio State for Power Up

C - Show Configuration and Status

F - Set Factory Defaults

Audio Status:Present - Channel 1

Enter Selection, or Q to quit:

To enter menu mode send the command: *0MM

To select a menu function, simply enter the letter on the left side of the menu and wait for the prompt. Example: Type the letter “S” Response: Enter Input Channel: Entering a 1 would select input channel one.

WEBSITE:

Visit our web site for product updates and additional information.

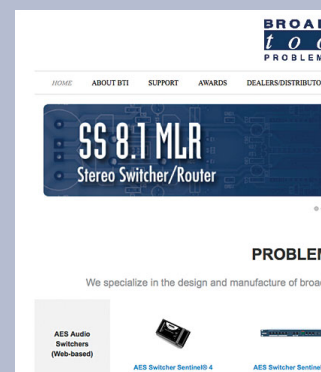

Specifications

Inputs/Outputs:	Any input level and impedance can be used. Inputs may be balanced or unbalanced. Output levels, impedance, distortion, noise and balancing will match that of the selected input.
Switching Method:	Passive. Mechanical latching sealed relays utilizing 2-form-C bifurcated-crossbar silver alloy with gold overlay contacts.
Logic:	Flash microprocessor with non-volatile memory.
Operation Control:	Front Panel: Momentary switches. Remote: Momentary or sustained, compatible with 5 volts CMOS/TTL logic, open collector or contact closures to ground. Serial: Multi-drop RS-232, 2400, 9600, 19200, 38400 8,N,1.
Status:	Front Panel: LED Indicators. Remote: Four channel open collector status outputs. One SPST Silence Sense relay. 1-amp @ 30 VDC maximum. Refer to the fractional schematic and/or text on the rear panel for connection details.
Interfacing:	Audio I/O: shielded RJ45 jacks. Remote control: (2) 8-position pluggable screw terminal blocks, mating connectors supplied. Serial: RJ-11 jack. Reversed RJ11 modular cable/female "S9" 9-pin D-Sub adapter supplied.
Power Requirements:	7.5 to 12 VDC @ >500 ma. Power supply with domestic connector supplied. International power supply optional.
Physical Dimensions:	5.66" x 7.125" x 1.58", aluminum extrusion chassis with (4) #6-32 screw thread mounting holes for optional RA-1 rack shelf.
Weight:	2.0 lb.
Shipping Weight:	3.0 lb.
Options:	RA-1 rack shelf, holds three units (1-RU), filler panels supplied. International power supply.

WEBSITE:

Visit our web site for product updates and additional information.

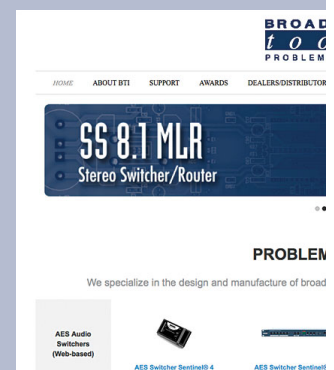

LIMITED WARRANTY

The term "Buyer" as used in this document refers to and includes both (but only) (a) any person or entity who acquires such an item for the purpose of resale to others (i.e., a dealer or distributor of an item), and (b) the first person or entity who acquires such an item for such person's or entity's own use.

Broadcast Tools warrants to each Buyer of any item manufactured by Broadcast Tools that the item will be free from defects in materials and workmanship at the time it is shipped by Broadcast Tools if the item is properly installed, used and maintained.

EXCLUSIVE REMEDIES

If Broadcast Tools is notified, in writing, of a failure of any item manufactured by Broadcast Tools to conform to the foregoing Limited Warranty within one (1) year following the date of the Buyer's acquisition of the item, and if the item is returned to Broadcast Tools in accordance with Broadcast Tools' instructions for confirmation by inspection of the defect (which at Broadcast Tools' election may include, without limitation, a requirement that the Buyer first obtain a Return Authorization number from Broadcast Tools, that the Buyer furnish proof of purchase in the form of an invoice and/or receipt, and that the Buyer prepay all freight charges associated with any return of the item to Broadcast Tools using such freight service as Broadcast Tools reasonably may specify), Broadcast Tools will repair or replace the defective item, or will refund the purchase price paid by the Buyer for the item. Broadcast Tools shall have the exclusive right to choose between these alternative remedies.

NO OTHER WARRANTIES OR REMEDIES

TO THE MAXIMUM EXTENT PERMITTED BY APPLICABLE LAW, BROADCAST TOOLS AND ITS SUPPLIERS DISCLAIM ALL OTHER WARRANTIES, EITHER EXPRESS OR IMPLIED, INCLUDING BUT NOT LIMITED TO IMPLIED WARRANTIES OF MERCHANTABILITY OR FITNESS FOR A PARTICULAR PURPOSE; AND THE FOREGOING ALTERNATIVE REMEDIES SHALL BE EXCLUSIVE OF ALL OTHER REMEDIES. THIS LIMITED WARRANTY GIVES YOU SPECIFIC LEGAL RIGHTS. YOU MAY HAVE OTHER RIGHTS, WHICH VARY FROM STATE/JURISDICTION TO STATE/JURISDICTION.

NO LIABILITY FOR CONSEQUENTIAL DAMAGES

TO THE MAXIMUM EXTENT PERMITTED BY APPLICABLE LAW, NEITHER BROADCAST TOOLS NOR ANY OF ITS SUPPLIERS SHALL HAVE ANY LIABILITY FOR ANY SPECIAL, INCIDENTAL, INDIRECT, CONSEQUENTIAL OR PUNITIVE DAMAGES WHATSOEVER (INCLUDING, WITHOUT LIMITATION, ANY DAMAGES FOR LOST PROFITS, BUSINESS INTERRUPTION, LOSS OF DATA OR INFORMATION, COST OF CAPITAL, CLAIMS OF CUSTOMERS, OR ANY OTHER PECUNIARY LOSS) ARISING OUT OF THE USE OF OR THE INABILITY TO USE ANY ITEM SUPPLIED BY BROADCAST TOOLS, EVEN IF BROADCAST TOOLS HAS BEEN ADVISED OF THE POSSIBILITY OF SUCH DAMAGES HAVE ANY LIABILITY FOR ANY SPECIAL, INCIDENTAL, CONSEQUENTIAL, EXEMPLARY OR PUNITIVE DAMAGES. THIS LIMITATION OF LIABILITY APPLIES WHETHER A CLAIM IS ONE ALLEGING BREACH OF A CONTRACT OR WARRANTY, NEGLIGENCE OR OTHER TORT, FOR THE VIOLATION OF ANY STATUTORY DUTY, THE FAILURE OF ANY LIMITED OR EXCLUSIVE REMEDY TO ACHIEVE ITS ESSENTIAL PURPOSE, OR ANY OTHER CLAIM OF ANY NATURE. BECAUSE SOME STATES AND JURISDICTIONS DO NOT ALLOW THE EXCLUSION OR LIMITATION OF LIABILITY FOR INCIDENTAL OR CONSEQUENTIAL DAMAGES, THIS LIMITATION MAY NOT APPLY TO YOU.

Broadcast Tools, Inc.

131 State Street
Sedro-Woolley, WA 98284 • USA

360.854.9559 **voice** • 866.783.1742 **fax**
support@broadcasttools.com **e-mail**
www.broadcasttools.com **website**

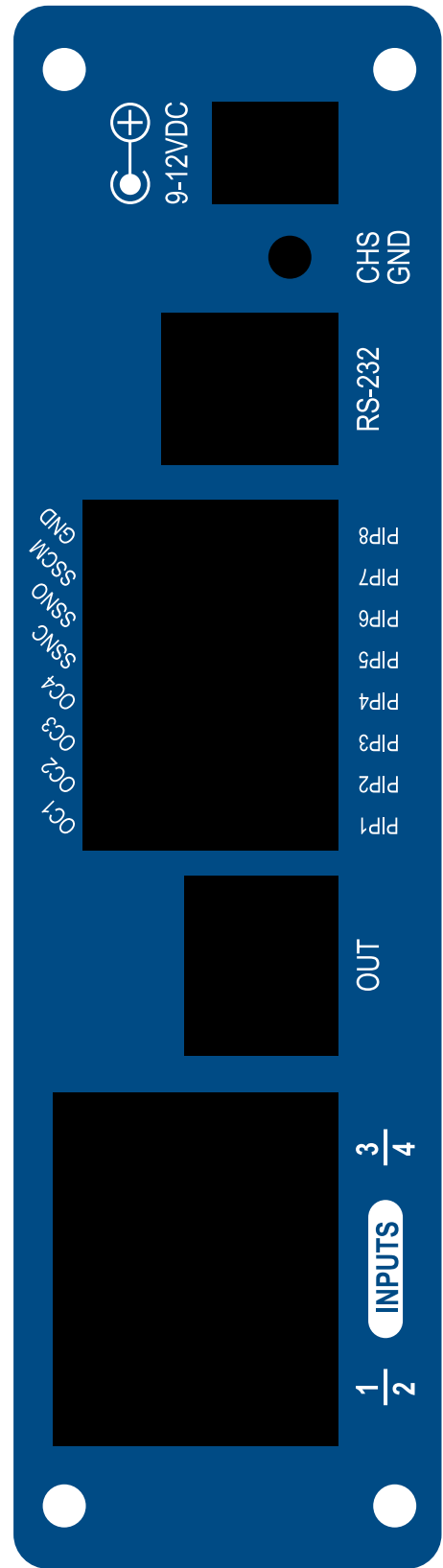
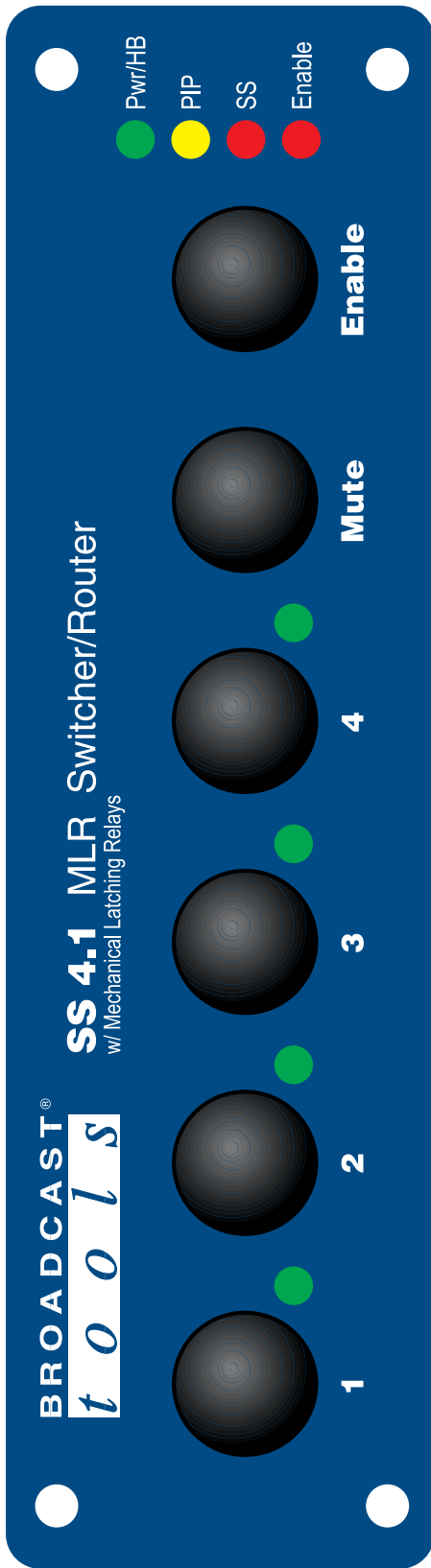

Component Layout

JP4: Front Panel
Enable Switch Jumper.
Default=Disable

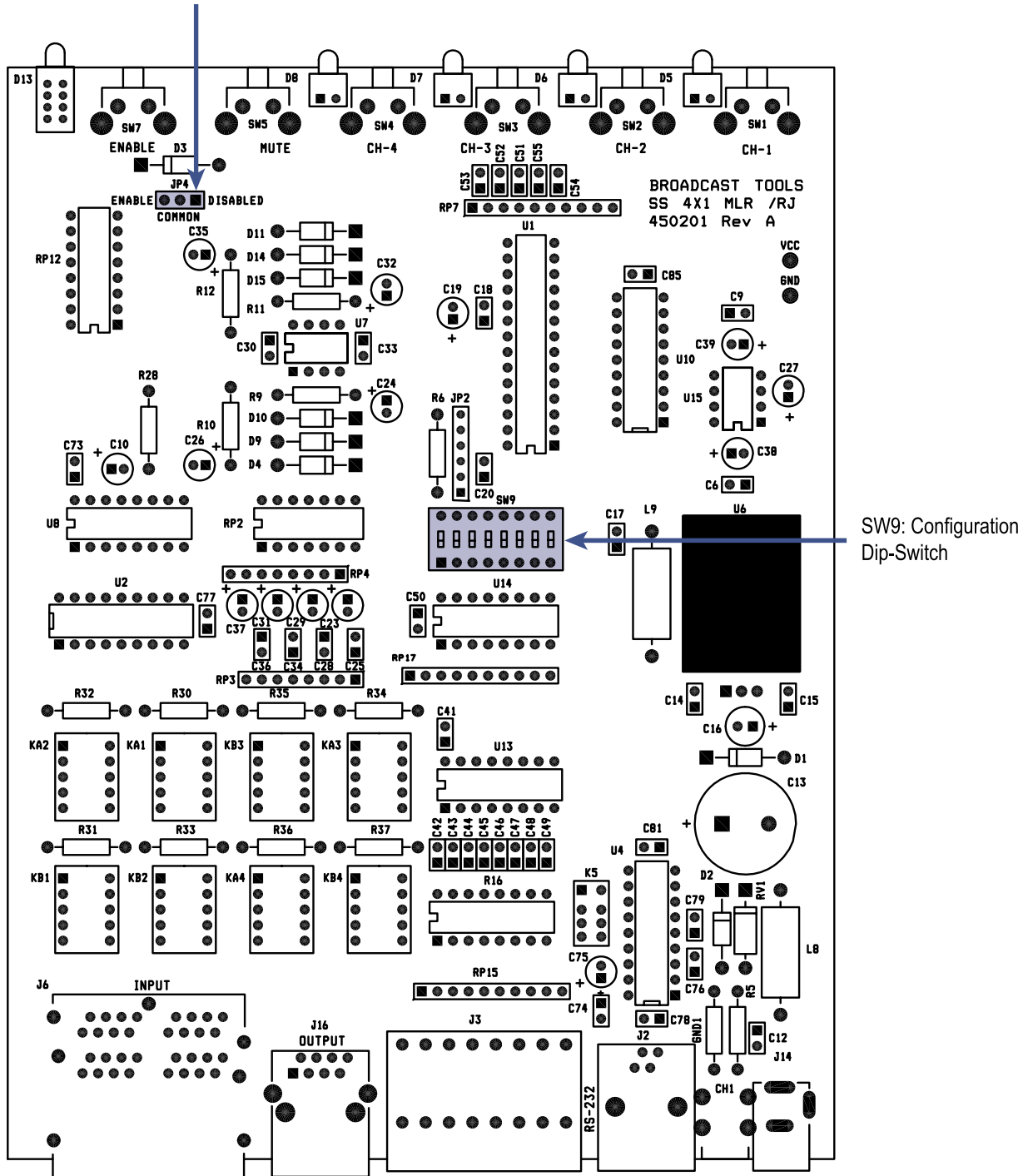

SW9: Configuration Dip-Switch

Fractional Schematic

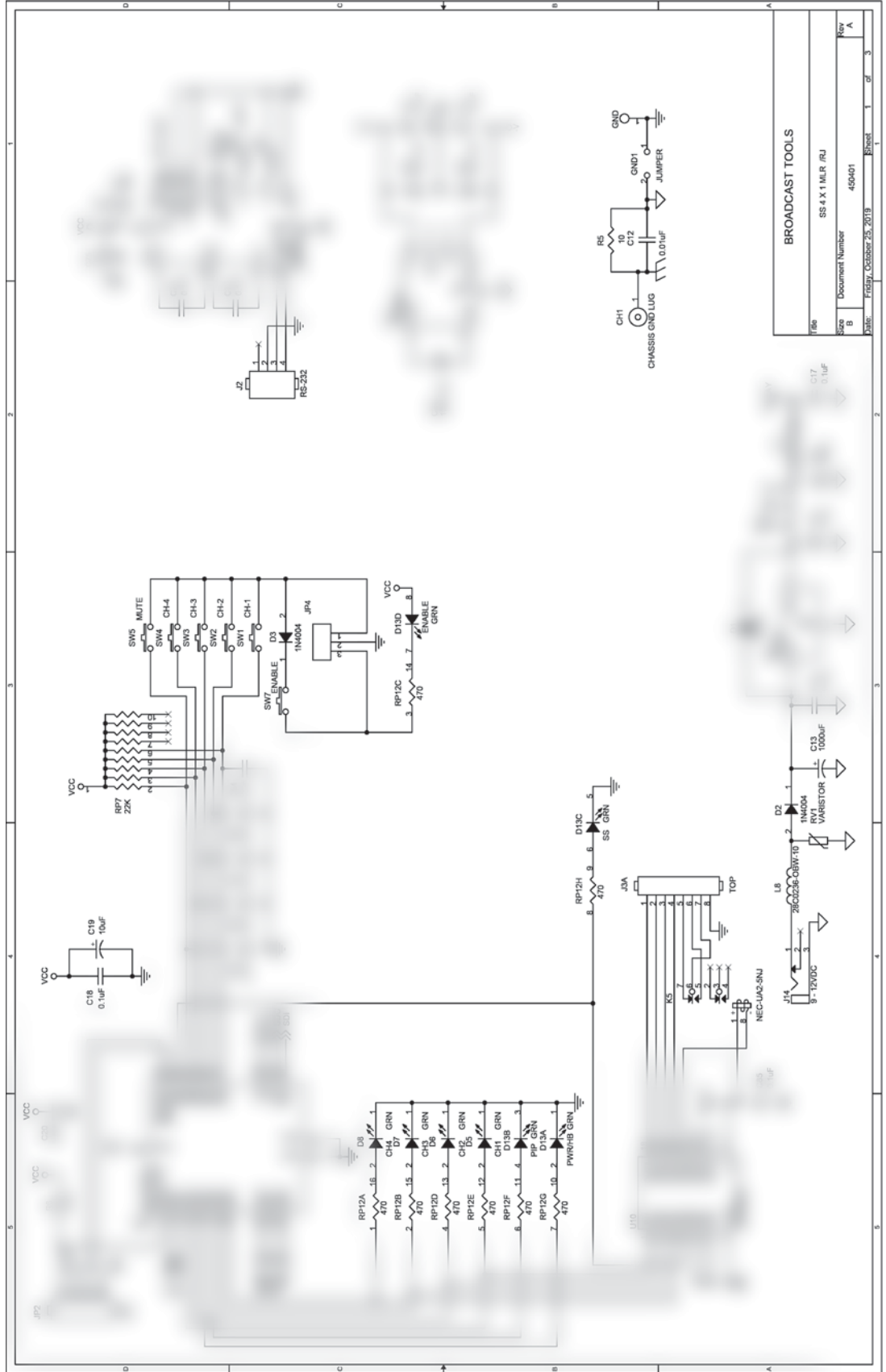

Fractional Schematic

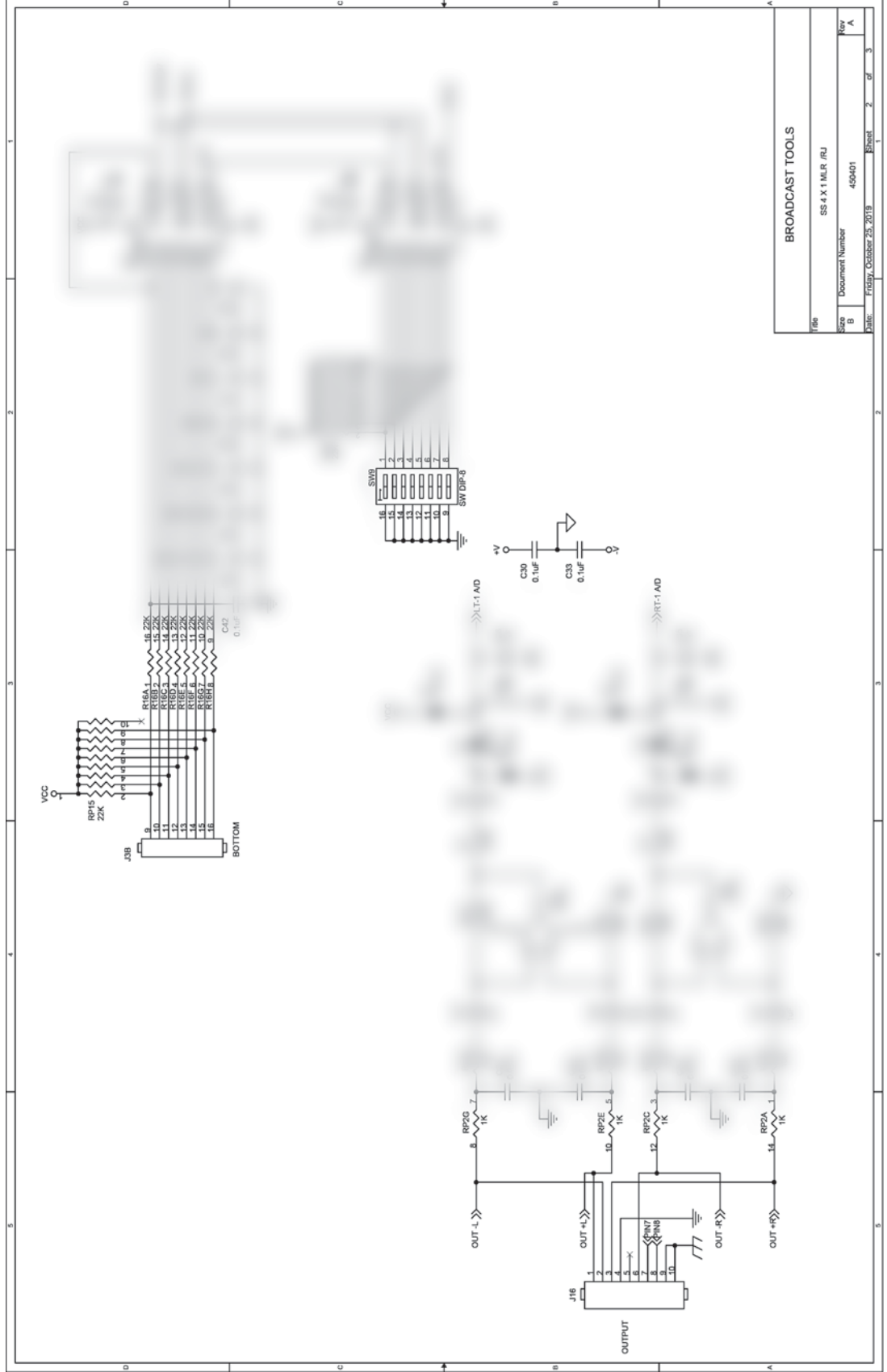

Fractional Schematic

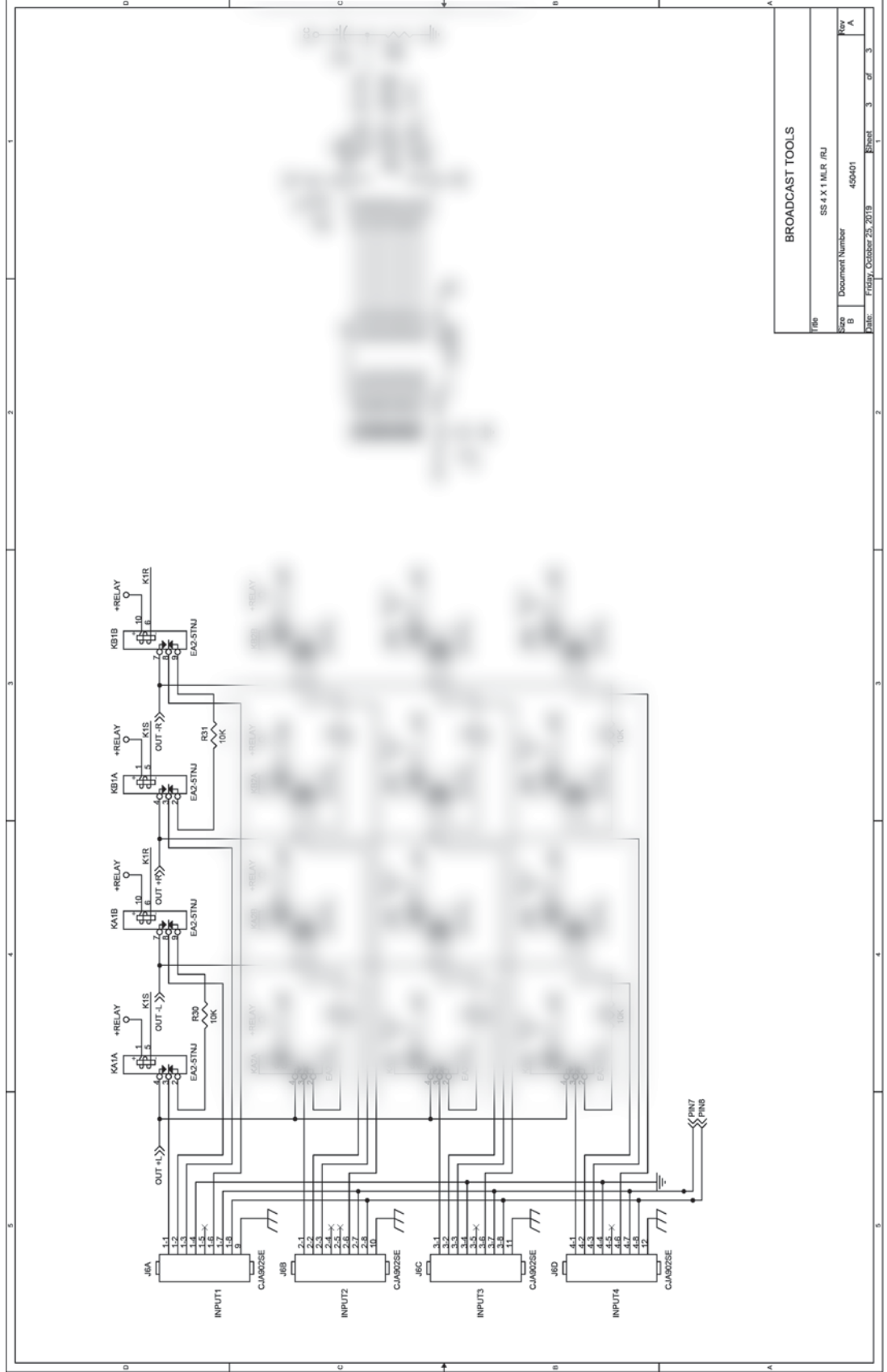

BROADCAST TOOLS			
File	SS 4 X 1 MLR /RJ	Sheet	3 of 3
Size	Document Number	450401	Rev
B			A
Date	FEBRUARY, OCTOBER 25, 2019	Sheet	3 of 3