

MAINTENANCE AND OPERATION
INSTRUCTION MANUAL

DB7007

Advanced FM Radio Re-Broadcast Receiver
with IP Audio & MP3 Backup Players



Contents

Introduction	6
Typographic conventions	7
General Information	8
Product Features	9
<i>Technical Specifications</i>	10
Panel Indicators, Switches and Connectors	12
<i>OLED Display</i>	12
<i>Soft Buttons</i>	12
<i>Navigational Buttons</i>	12
<i>Front panel</i>	12
<i>Phones</i>	12
<i>Indicators</i>	13
<i>LED bargraphs</i>	14
<i>Rear Panel</i>	15
<i>Rear Panel Alarm Terminal</i>	16
Before you start	17
<i>Safety Precautions</i>	17
<i>Operating Environment Recommendations</i>	17
<i>RF Environment – precautions, installation specifications and antenna types</i>	18
<i>De-emphasis and Pre-emphasis selection</i>	18
<i>Connecting – AC Power and Voltage Selection</i>	19
Operation	20
<i>Re-broadcasting limitations</i>	20
<i>Signal Strength</i>	20
<i>Multipath Distortion</i>	20
<i>Co-channel Interface</i>	21
<i>First time power on</i>	22
<i>Front Panel LCD Display, Navigational & Soft Buttons</i>	23
<i>Header Area</i>	23
<i>Soft Buttons</i>	24
<i>How to change device parameters</i>	25
<i>Set-up menu title</i>	25
<i>Navigation area</i>	25
<i>Numerical parameter</i>	25
<i>Enumerated parameter</i>	25
<i>IP address</i>	26
<i>IP port</i>	26
<i>Date</i>	26
<i>Time</i>	26
<i>Timer</i>	26
<i>String</i>	27
<i>Main screen working area</i>	29
Operating Modes and Pages	30
<i>Bandscan Page</i>	31
<i>Span control state</i>	33

<i>Marker control state</i>	35
<i>Parameter control state</i>	36
<i>Bandscan page parameters</i>	37
<i>Levels Page</i>	38
<i>Graphs Page</i>	41
<i>Settings Page</i>	45
<i>Main Station</i>	45
<i>Backup Station</i>	46
<i>Tuner</i>	46
<i>Backup</i>	47
<i>MPX</i>	48
<i>MPX out Configuration</i>	48
<i>Stereo Generator</i>	49
<i>Injection levels</i>	49
<i>MPX limiter</i>	49
<i>RDS</i>	50
<i>Communication</i>	51
<i>Security</i>	53
<i>Keyboard lock</i>	53
<i>Keyboard unlock</i>	54
<i>Alarms</i>	55
<i>GP Outputs</i>	56
<i>Audio/MPX Outputs</i>	56
<i>Device</i>	57
<i>Status Page</i>	58
<i>[RDS Decoder] PAGE</i>	60
<i>RDS/RBDS Page Main view</i>	60
<i>RDS/RBDS RAW Data view</i>	61
<i>RDS/RBDS AF list view</i>	61
<i>RDS/RBDS Statistics view</i>	61
<i>RDS/RBDS Sequence view</i>	62
WEB Interface	63
<i>Manual IP address Identification</i>	63
<i>Network Discovery</i>	63
<i>Access</i>	64
<i>Main Screen</i>	65
<i>RDS/RBDS Screen</i>	70
<i>BandScan Screen</i>	71
<i>Status Screen</i>	72
<i>Log Screen</i>	73
<i>General Settings Screen</i>	74
<i>Tuner Settings Screen</i>	75
<i>RF Loss Protection Mode</i>	76
<i>PI Protection Mode</i>	77
<i>Backup Settings Screen</i>	78
<i>MP3 files upload via FTP</i>	79
<i>MPX Settings Screen</i>	79

<i>RDS/RBDS Settings Screen</i>	80
<i>Alarms Settings Screen</i>	81
<i>Communication Settings Screen</i>	82
<i>Network</i>	82
<i>HTTP Server</i>	83
<i>FTP Server</i>	83
<i>SNMP Agent</i>	83
<i>Syslog</i>	83
<i>GSM Modem</i>	83
<i>Audio Stream Server</i>	83
<i>E-mail</i>	84
<i>UECP UDP Relay & UECP TCP Server</i>	84
<i>USB Port</i>	84
<i>Outputs Settings Screen</i>	85
<i>Other Settings Screen</i>	86
<i>Firmware Update</i>	86
<i>Storage</i>	86
<i>System Log</i>	86
<i>Factory Defaults</i>	86
<i>Reboot</i>	86
APPENDIX 1	87
<i>Alarm Triggers</i>	87
<i>Alarm Notification</i>	89
APPENDIX A	90
<i>RDS: Europe vs America</i>	90
<i>The RDS System</i>	90
APPENDIX B	91
<i>Download/Upload files via FTP</i>	91
1. <i>FTP Server Settings</i>	91
2. <i>IP Router and Port Translation Settings</i>	91
3. <i>Example of FTP Client (FileZilla) Settings</i>	92
APPENDIX C.1	93
<i>PTY Code Description Used in RBDS Mode – North America</i>	93
APPENDIX C.2	94
<i>PTY Code Description Used in RDS Mode – Europe, Asia</i>	94
WARRANTY TERMS AND CONDITIONS	95
Product Registration Card	96

THIS PAGE
IS INTENTIONALLY
LEFT BLANK

Introduction

DEVA Broadcast Ltd. is an international communications and high-technology manufacturing organization, its corporate headquarters and facility located in Burgas, Bulgaria. The company serves the broadcast and corporate markets worldwide – from consumers and small businesses to the largest global organizations. It is dedicated to the research, design, development and provision of advanced products, systems and services. DEVA launched its own brand back in 1997 and has nowadays evolved to become known as a market leader and internationally reputed manufacturer of user-friendly, cost-effective and innovative broadcast products.

Creativity and innovation are deeply woven into DEVA corporate culture. Through successful engineering, marketing and management our team of dedicated professionals creates future-oriented solutions to improve customers' performance. You may rely that all issues communicated to our crew would be addressed accordingly. We pride ourselves on our pre and post-sales support and purchase services, which along with the outstanding quality of our radio gear have won us due respect and the market authority position.

DEVA best-of-breed solutions have become the best sellers for our partners. The strategic partnerships which have been formed with industry leaders during all these years that we have been operating on the broadcasting market, have proved us a reliable business partner and a valuable asset, as our dealers worldwide would confirm. In constant pursuit of precision and long-term satisfaction, DEVA enhances the reputation of our partners and clients alike. Furthermore, we have already a proven merit as a credible partner provider.

Our portfolio offers complete line of high quality and competitive products for FM and Digital Radio, Radio Networks, Telecommunication Operators and regulation authorities. For almost two decades of intensive software and hardware development, we have achieved a unique price-performance and endurance of our product lines. Our company's multitude of equipment and services is in line with the latest technologies and key trends. The most recognizable characteristics attributed to DEVA products are their clear-cut, streamlined design, easiness of use and cost-effectiveness: simplicity of forms but multiplicity of functions.

For us there is no stage when we deem that we have reached the most satisfactory level in our work. Our engineers are in constant pursuit of new ideas and technologies to be captured in DEVA solutions. Simultaneously, a strict control is being exercised at each step of any new development. Experience and hard work are our fundament but the continuous improving process is what we never leave aside. DEVA participates on a regular basis in all landmark broadcasting events, not only to promote its products, but to exchange valuable know-how and experience. We are also engaged in international large-scale projects involving radio and audio solutions which makes us even more competitive on the global market.

All DEVA products are developed and produced in accordance with the latest ISO 9001 quality control standards.

Typographic conventions

This manual uses the following typographic conventions:

Style	Used for
NOTE	Important notes and recommendations
Example	Used when example text is cited
“Menu” on page XX.	References
[OK]	Interface Interactive buttons.
<i>Settings</i>	Menu paths are represented as follows: <i>Settings</i> > <i>General</i> > <i>Backup</i>

General Information

DB7007 is a second generation digitally-tuned FM Re-Broadcast Receiver. Considering the needs of the most demanding broadcasters and continuously supplementing new features to our devices, DEVA has enhanced DB7007 to be smarter and fully functional unit, equipped with two high-selective DSP-based FM tuners.

Thanks to the built-in monitoring system, upon audio loss at the inputs, DB7007 will not only notify the maintenance staff, but will also automatically switch to the second back-up RF Station. In case a fail of the second station is detected, DB7007 will shift to the incorporated IP Stream, MP3/AAC back-up audio source player. It is essential that the back-up sources priority is user-defined. The audio files and playlists can be uploaded in the device's internal memory directly from your PC, via any FTP client. When the signal at the default input is restored, the DB7007 will automatically switch back to it. Depending on your preferences, several types of alarm notifications are utilized - E-mail, SNMP and SMS (via the optional GSM modem).

The DB7007 has an easy to read, high-resolution OLED graphical display, front panel alarm indicators and ultra-bright bargraphs with up to 40 LED segment indicators that allow reading at a glance of the MPX, Left and Right audio and the RF level, as well. The RF (IF) signal is digitized as soon as it enters the device and all signal processing is then made through DSP algorithms, thus guaranteeing measurement reproducibility over time. The IF bandwidth filters guarantees unprecedented signal selectivity, while the difficult adjacent-channel problem will be completely solved. DEVA advanced DB7007 will measure all important parameters of the FM transmission.

Additionally, the RDS information contained in the processed MPX signal is easily visualized and represented as RDS/RBDS Data and detailed RDS/RBDS Statistics. The utilized Band Analyzer function presents an overview of all available FM signals, plus the RF signal strength. Scans can be performed within any section of the FM band in 4 different frequency steps. The consequently generated spectrum diagram visualizes the relation RF Level vs. Frequency.

Adhering to the underlying principle of all DEVA products to be as much user-friendly as possible, the DB7007 can be also easily controlled through the built-in Web server - you can use a standard web browser to monitor the status or to make any adjustments (iOS and Android devices are also supported); the supplied free of charge DEVA Device Manager Software or alternatively, through the very intuitive user interface.

Designed to ensure premium broadcasting experience, DB7007 will meet and even exceed your expectations for a first rank re-broadcast receiver.

Product Features

- Two independent DSP based Digital FM Tuners
- Dual antenna ports with built-in RF attenuator
- Up to 100 dB μ V direct RF Antenna Input
- Selectable wide range IF filter bandwidths
- User selectable, 87.1-107.9 MHz (CCIR), 65-74 MHz (OIRT), 76-95 MHz (Japan)
- Built-in DSP based Stereo Re-encoder
- Advanced SNMP Ver.2C support
- Professional AES/EBU, SPDIF and Optical Digital audio outputs
- Wide angle, easy to read OLED display
- Very Intuitive Navigational Menu
- Selectable De-emphasis - 50 μ s and 75 μ s
- Real Time Audio Program Streaming
- Remote Listening via optional GSM modem
- Apple and Android devices support
- SNTP for automatic sync of the built-in clock
- RDS and RBDS decoder with BER meter
- TCP/IP Remote monitoring and control via SNMP and WEB Interface
- Alarm dispatch via E-mail, SMS, SNMP and GPO
- Multiformat Backup IP Audio player
- Built-in Backup MP3 Player
- Lots of Storage for over 24 hours of non-repeating audio playback
- Adjustable MIN/MAX alarms for RF, Pilot, L & R Audio Levels
- Adjustable MIN/MAX alarms for MPX & RDS
- Digital Volume Control of all Audio Sources
- Complete status reporting with SMS via optional GSM modem
- Protected access to the device settings
- Balanced Analog Audio Outputs on XLR Connectors
- USB communication interface for local connectivity
- Headphone output with front panel level control
- Easy and intuitive Windows Application
- Firmware updates will ensure improved operation
- Accurate front-panel metering for local use
- Restore Factory Parameters option
- Wide operating voltage range: 100-240V AC
- 19" Professional Case for high RF immunity
- Easy Installation and Setup

TECHNICAL SPECIFICATIONS

RF INPUT	
Tuning Range	User selectable, 87.1-107.9 MHz (CCIR), 65-74 MHz (OIRT), 76-95 MHz (Japan)
Tuning Step	10, 20, 50, 100 kHz
Tuner Sensitivity	30 dB μ V
Antenna Ports	Dual, 2 x BNC Connectors, 50 Ω
Antenna Ports Isolation	> 40 dB
Internal Attenuator	0, 10, 20 and 30 dB
Dynamic range	100 dB
FM DEMOD	
IF Filter Bandwidth	15 Increments (25kHz - 157kHz, Auto)
Frequency Response	\pm 0.1 dB, 10 Hz to 86 kHz
Dynamic range	90 dB
STEREO DECODER	
Frequency Response (L&R)	\pm 0.1 dB, 10 Hz to 15 kHz
SNR (Stereo)	60 dB, 50 μ s de-emphasis
THD	0.1%, 10 Hz to 15 kHz, 50 μ s de-emphasis
Separation	50 dB, 50 Hz to 10 kHz, 50 μ s de-emphasis
Crosstalk	52 dB
BACKUP IP AUDIO PLAYER	
Number of Streams	one main and two alternative streams with auto-switch on failure
Stream Clients	shoutcast, icecast
Stream Formats	PCM (32, 44.1, 48kHz), MPEG1 Layer 3 (MP3), HE-AAC (v.1 and v.2)
Bit Rates	All standard bit rates, including VBR
Number of Channels	Mono, Stereo
Buffer Size Adjust	5Kb to 64Kb
Digital Gain Adjust	-10db to +10dB
BACKUP MP3 PLAYER	
Storage Capacity	2Gb on SD Card
Supported encoders	HE-AAC (v.1 and v.2), MPEG-1 Layer 3
MP3 bit rates	32-320 kbps and VBR
Sample rates	All sampling frequencies specified by MPEG1 L1/L2/L3 (32, 44.1 and 48kHz); MPEG2 L1/L2/L3 (16kHz, 22.05kHz and 24kHz) and MPEG2.5 L3 (8kHz, 11.025kHz, and 12kHz)
Supported file types	*.MP3, *.AAC, *.M4A, *.M3U
Playback modes	Alphabetical ascending and descending, Shuffle, Playlist and Shuffled playlist
Remote file management	Build-in FTP server
Digital Gain Adjust	-10db to +10dB

RDS DECODER	
Standards	European RDS CENELEC; United States RBDS NRSC
Error Correction & Counting	Yes
AF Decoding	Yes
CT (Time/Date)	Yes
PI, PTY, DI, MS	Yes
TA/TP	Yes
RT (Radio Text), RT+	Yes
PS (Program Service name)	Yes
ODA	Yes
Group Analyzer	Yes
BER Analyzer	Yes
Group Sequence Display	Yes
RDS RAW Data Display	Yes
METERING ACCURACY	
RF Level	±1 dB, 0 to 100 dB μ V
Total, Pos, Neg	±2 kHz, 10 to 100 kHz, 1 kHz resolution
Pilot, RDS	±0.5 kHz, 1 to 12 kHz, 0.2 kHz resolution
Audio	±1 dB, +10.0 to -55.0 dB, 0.1 dB resolution
OUTPUTS	
Composite	+12 dBu @ 75kHz, 75 Ω , unbalanced BNC Connector
Audio (L, R)	+6 dBu, 600 Ω balanced XLR Connector
AES3 (L, R)	5.0 Vp-p, 110 Ω , balanced XLR Connector
SPDIF (L, R)	3.0 Vp-p, 110 Ω , unbalanced BNC Connector
Optical (L, R)	Transmitter, TOSLINK
Alarms	Programmable terminals on rear panel, optoisolated
Headphone	6,3mm (1/4") Phone Jack
COMMUNICATION INTERFACES	
USB	B-type Connector
Ethernet 10/100 Base-T	RJ45 Connector
GSM Modem	15 pin Male D-Sub Connector
MEASUREMENT STORAGE	
Storage	2GB Build-in Memory Card
Data format	Text, CSV
POWER	
Voltage	100-240V / 50-60 Hz / 25W
Connector	IEC320
SIZE AND WEIGHT	
Dimensions (W;H;D)	485 x 44 x 180 mm
Shipping Weight	540 x 115 x 300 mm / 2.7kg

Panel Indicators, Switches and Connectors

NOTE: Unless where otherwise clearly stated, all front panel and display indicators, measurements and graphs represent the information received from the Main Station tuner (ANT1).



OLED DISPLAY

DB7007 has easy to read, high-resolution OLED graphical display that visualizes all measurements of the received signal and DB7007 settings.

SOFT BUTTONS

Used for navigation through the menus, quick access to the parameters, modes, functions and to alter their values. The Soft Buttons indicators are placed on the bottom side of the OLED display. Depending on the currently selected menu context the indicators change their function. The Soft Buttons will be referred as (left-to-right) [SB1], [SB2], [SB3] and [SB4].

NAVIGATIONAL BUTTONS

[UP], [DOWN], [LEFT], [RIGHT] and [OK] buttons, as the Soft Buttons, are used to navigate through the menus selecting various functions and parameters of DB7007.

FRONT PANEL

NOTE: Unless where otherwise clearly stated, all front panel and display indicators, measurements and graphs represent the information received from the Main Station tuner (ANT1).

Phones

Phones jack to monitor the signal. Headphones volume can be adjusted in two methods:

1. Using the [UP] and [DOWN] buttons in the home screen;
2. Through the front panel navigational menu: *Settings> Audio / MPX Outputs> Phones Volume.*



Indicators

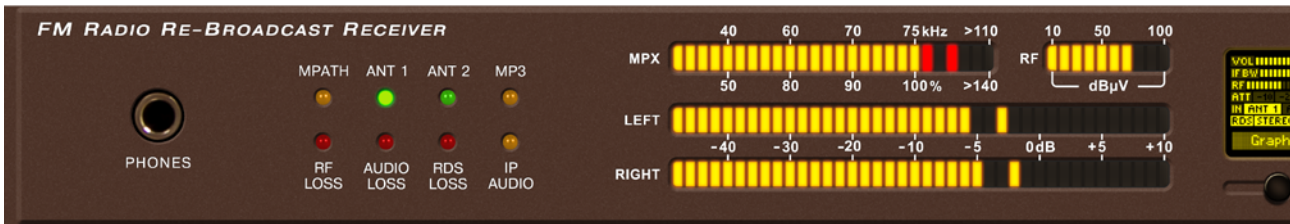

- **Mpath** – Indicates the presence of strong multipath distortion of the RF signal. The indication threshold and time can be set trough: *Settings> Device> Loss> Multipath Threshold / Multipath Timeout*



- **ANT 1** – Indicates that the Main Station is the current audio source.
- **ANT 2** – Indicates that the Backup Station is the current audio source.
- **MP3** – Indicates that the MP3 backup player is the current audio source.
- **IP Audio** – Indicates that either the IP Audio Client or the RTP receiver is the current audio source.
- **RF LOSS** – will be indicated whenever the level of the RF signal of the Main Station drops below the selected threshold. The RF LOSS detection threshold and time can be set trough: *Settings> Main Station> RF Loss Threshold / RF Loss Timeout*





- **AUDIO LOSS** will be indicated whenever the level of the Left and Right audio channels drops below the selected threshold. The **AUDIO LOSS** detection threshold and time can be set trough: **Settings> Device> Loss> Audio Threshold / Audio Timeout**



- **RDS LOSS** will be indicated whenever the level of the **RDS** drops below the selected threshold. The **RDS LOSS** detection time can be set trough: **Settings> Device> Loss> RDS Loss Timeout**

LED bargraphs



- **MPX** – composed of 26 segments, the bargraph indicating the deviation in kHz (European RDS mode) and in % (US RDBS mode).
- **RF** – composed of 10 segments, the bargraph shows the measurements from **10 dB μ V** to **100 dB μ V**.
- **Left Audio Channel** – composed of 40 segments, the bargraph shows the measurements from **-50 dB** to **+10 dB**;
- **Right Audio Channel** – composed of 40 segments, the bargraph shows the measurements from **-50 dB** to **+10 dB**;

REAR PANEL

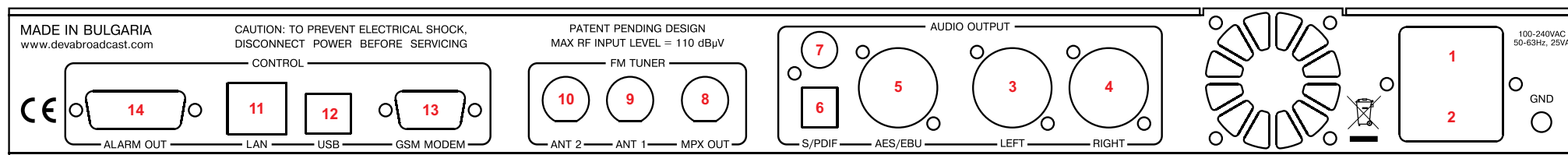
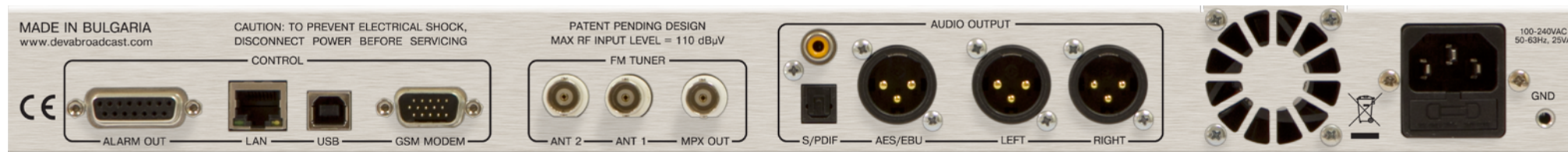

3. Mains connector, 110-240VAC, IEC-320 C14 type;
4. Fuse holder – 1A;
5. Audio Left Output - XLR;
6. Audio Right Output - XLR;
7. Audio AES/EBU Output - XLR;
8. Audio SPDIF Output - RCA;
9. Audio Optical Output - TOSLINK;
10. MPX Output - BNC;
11. RF Input 1 (Antenna 1) - BNC;
12. RF Input 2 (Antenna 2) - BNC;
13. Ethernet T-BASE10/100 RJ45;
14. USB – type B;
15. GSM Modem – Male D-Sub 15 pins High Density;
16. GPO – Opto-isolated, Female D-Sub 15 pins.

REAR PANEL ALARM TERMINAL

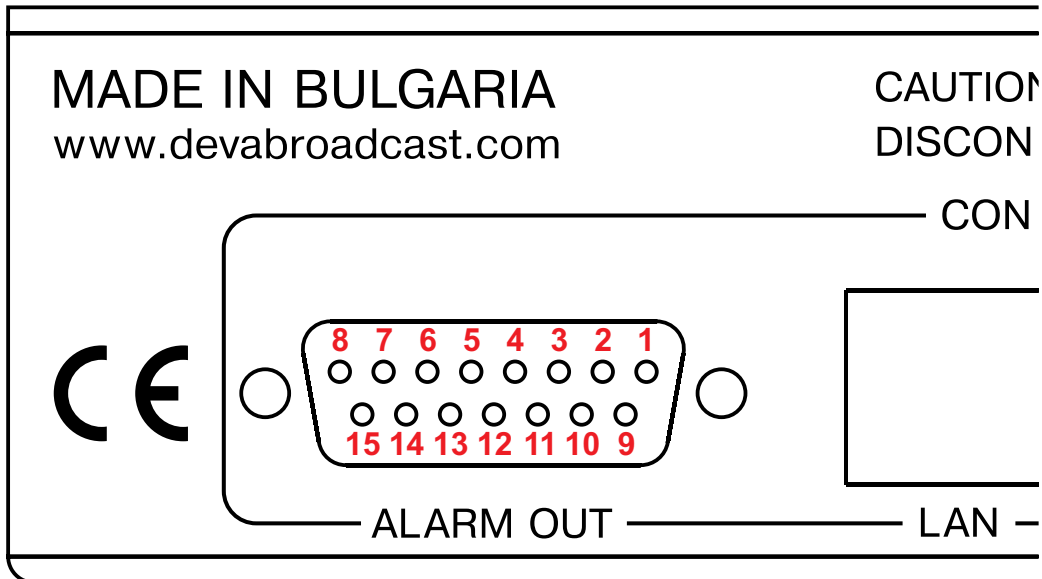

- | | |
|--------------------|-------------------|
| 1 - GPO1 Collector | 9 - GPO1 Emitter |
| 2 - GPO2 Collector | 10 - GPO2 Emitter |
| 3 - GPO3 Collector | 11 - GPO3 Emitter |
| 4 - GPO4 Collector | 12 - GPO4 Emitter |
| 5 - GPO5 Collector | 13 - GPO5 Emitter |
| 6 - GPO6 Collector | 14 - GPO6 Emitter |
| 7 - GPO7 Collector | 15 - GPO7 Emitter |
| 8 - GND | |

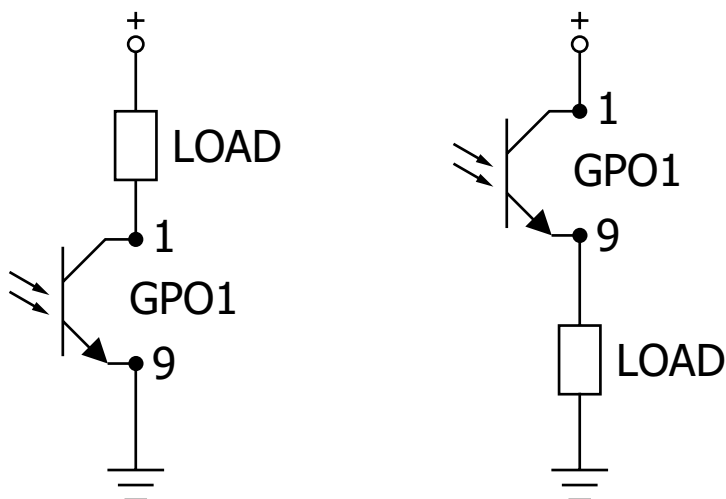

Before you start

SAFETY PRECAUTIONS

- The servicing of electronic equipment should be performed only by qualified personnel;
- Before removing the covers DB7007 must be switched off and the mains cable unplugged;
- When the equipment is open, the power supply capacitors should be discharged using a suitable resistor;
- Never touch the wires or the electrical circuits;
- Use insulated tools only;
- Never touch the metal semiconductor. They might carry high voltages;
- For removing and installing electronic components, follow the recommendations for handling MOS components.

ATTENTION: DB7007 has an internal Lithium battery. Do not try to re-charge this battery!
Please contact us for detailed instructions in case the battery should be changed.

OPERATING ENVIRONMENT RECOMMENDATIONS

For normal operation of DB7007, we recommend following the instructions listed below.

- Install the unit in places with good air conditioning. DB7007 is designed to operate within the ambient temperature range of 10 to 50°C. The equipment rack should be ventilated in order for the device to keep its internal temperature below the maximum ambient temperatures;
- We do not recommend installation in rooms with high humidity, dusty places or other aggressive conditions;
- Locate the device away from abnormally high RF fields;
- Use only checked power supply cables. We strongly recommend the usage of shielded cables;
- Connect DB7007 only to reliable power supply sources. In case of unstable power supply, please use Uninterruptible Power Supply (UPS);
- Use the device only with its top cover on to avoid electromagnetic anomalies. Otherwise, this may cause problems with the normal functionality of the unit;
- For the normal remote operation of the unit, connect DB7007 to a good quality Internet connection;
- For the normal operation of DB7007, check if the network settings past through all the required data traffic.

RF ENVIRONMENT – PRECAUTIONS, INSTALLATION SPECIFICATIONS AND ANTENNA TYPES

The observation of the RF Environment, in which DB7007 is functioning, is necessary for ensuring normal and reliable function of the device. In order for the device to work properly, the best conditions according the standards listed below should be provided.

The usage of an external antenna is required because DB7007 is used for off air re-broadcasting away from the transmitter site. Proper outdoor FM antenna, antenna location and direction should be selected. The three most popular antenna types are: omni directional, unidirectional dipole and directional multi-element array antenna.

Because of the low antenna gain, the bad signal to noise ratio (compared to any directional antenna) and its high multipath interfaces reception, we do not recommend the usage of omni directional antenna with DB7007.

The other type antennas: unidirectional dipole and directional multi-element array antenna are much proper for your needs. We recommend the usage of factory made antenna or antenna system, manufactured specially for the FM Radio Band 88 – 108 MHz.

The recommended working RF signal strength is in the range of 55-90 dB μ V. If the input RF level is above this range, we recommend using external RF attenuators with attenuation value between 20 – 90dB.

After selecting the antenna type that will meet your needs, the next step is its installation. The following important principles should be considered:

- Install the antenna far enough from walls, roofs, buildings or any transmitting equipment;
- The minimum spacing between the antenna and the closest object should be more than 3 meters.

One unit DB7007 re-broadcast receiver is used for re-broadcasting of one transmitter site, transmitting more than one program. In such cases, the best antenna that can be used is a directional antenna directed exactly to this site.

DE-EMPHASIS AND PRE-EMPHASIS SELECTION

As well known, there are three different de-emphasis selections. One of the problems with the high quality VHF FM transmissions is that the increased audio bandwidth means that background noise can often be perceived. It is particularly noticeable towards the treble end of the audio spectrum, where it can be heard as a background hiss. To overcome this, it is possible to increase the level of the treble frequencies at the transmitter. The frequencies are correspondingly attenuated at the receiver in order to restore the balance. This also has the effect of reducing the treble background hiss which is generated in the receiver. The process of increasing the treble signals is called pre-emphasis, and reducing the treble signals in the receiver is called de-emphasis. The rate of pre-emphasis and de-emphasis is expressed as a time constant. It is the time constant of the capacitor-resistor network used to give the required level of change.

In UK, Europe and Australia the time constant is 50 μ s whereas in North America it is 75 μ s. The de-emphasis and pre-emphasis should be selected depending on the region you are located or can be disabled.

CONNECTING – AC POWER AND VOLTAGE SELECTION

Before connecting the AC Power, make sure that the fuse rating is in accordance with the mains supply at your location. DB7007. Power Supply Factory Settings are:

- 100-240 VAC;
- 1Amp Fuse.

CAUTION:

DB7007 will be damaged permanently if improper AC power supply voltage is applied. The warranty DOES NOT cover damages caused by applying improper supply voltage or usage of improper fuse.

Operation

RE-BROADCASTING LIMITATIONS

Signal Strength

The signal strength is a major factor when a signal is re-broadcasted, measured and evaluated. FM compared to AM is less susceptible to the inherent noise of the radio reception.

When speaking about FM broadcasting, it is the monaural reception which can tolerate and profit from a much narrower IF bandwidth. The stereo reception adds all noise present in the 23 – 53 kHz sub-band. The amplitude component (AM) of the sub band is converted down to audible noise and added to the program signal. That is why the noise performance of FM-stereo can be as much as 20 dB worse than that of monaural broadcast.

Better reception and measurement can be obtained by using highly directional outdoors antenna. This will improve the signal strength and contribute in eliminating the multipath distortion.

Multipath Distortion

In FM reception, regardless of overall signal strength, a very important consideration is that obstacles, which an FM signal may encounter in the line-of-sight path tend to reflect and disperse the signal in many directions. In many locations, especially in urban areas where many tall buildings interfere with the direct transmitted signal or in suburban areas surrounded by hills or mountains, an FM receiver may pick up a station's primary signal but, also, several secondary reflections coming from various directions. These reflections arrive at the receiver out-of-phase, slightly delayed in time with the primary signal and tend to blur or distort the principal signal. The degree of distortion depends on the number and relative strength of the reflections.

The result, known as multipath distortion in FM reception can range from a low-level fuzziness to a severely distorted sound quality, particularly at the high frequencies or treble. Multipath distortion is especially troublesome in FM stereo reception.

DB7007 has a multipath distortion detector and Front panel multipath LED indicator with adjustable threshold. A bar graph indicator representing the multipath level of the received signal can be reached under *LEVELS* menu.

Co-channel Interface

In many populated areas, there is not enough space in the radio spectrum and stations might be jam-packed. Poor frequency planning may also result in the mutual interface between the broadcasting stations.

The inherent broad bandwidth of DB7007 re-broadcast receiver is vulnerable from stations working on the nearby frequencies, where signal strength will be the most important factor – the stronger the interfering station, the stronger the interference effect.

We recommend you to observe the independent positive and negative deviation readings in order to identify adjacent channel interference. If the positive deviation is higher than the negative one, interference from a strong station above the monitored frequency would be indicated and vice-versa. For example, the negative deviation can probably be trusted as an indication of total carrier modulation, though this should be confirmed in free of interference RF environment.

Anyhow, the program deviation should be fairly symmetrical about the carrier frequency. Using the built-in Attenuator can be of some help, but the usage of an outdoors directional antenna could improve the situation with unwanted adjacent working stations. Other solutions include a band-pass filter at the primary frequency or a trap at the interfering frequency.

FIRST TIME POWER ON

This chapter will guide you through the initial set up of DB7007 FM Radio re-Broadcast Receiver. Applying these principles, you can simplify the process and save yourself extra time and effort.

The items needed for the configuration are a pair of headphones and connection to an outdoor antenna. The different types of antenna are described previously in this manual ([see “RF Environment - precautions, installation specifications and antenna types” on page 18](#))

1. Install the unit on its operation place;
2. Before connecting the AC Power, make sure that the fuse rating is in accordance with the mains supply at your location. DB7007 Power Supply Factory Settings are: 100-240 VAC; 1Amp Fuse;
3. Connect the antenna cable to the RF antenna input connector located on the rear panel of the device;
4. Plug the headphones into the front panel jack;
5. Use the front panel navigational menu to set the desired station – **Settings> Tuner> Frequency**. The station should be clearly heard through the phones. If needed, reposition the antenna in order to improve the reception.

These are the first basic steps in DB7007 operation. Detailed explanation on how to configure and explore your device is given in the next chapters.

FRONT PANEL LCD DISPLAY, NAVIGATIONAL & SOFT BUTTONS

NOTE: Unless where otherwise clearly stated, all front panel and display indicators, measurements and graphs represent the information received from the Main Station tuner (ANT1).

DB7007's OLED display has three function areas: Header, Soft Buttons and Main Screen Work area.



Header Area

The *Header* is located on the left part of the screen. The header content is determined according to the work area context and may include the following functions:

91.10 FM – Frequency Indicator, showing the currently selected frequency, in MHz, is located in the upper left corner;

ATT -10 – Attenuator Indicator – represents the currently selected position of the active Antenna Input. Attenuator's position can be set manually or automatically by the device;

STEREO 50µ – Indicator for Stereophonic Information-contains information about the received signal and currently selected de-emphasis time constant;

RDS – Indicator for RDS presence of information contained in the received signal;

POWER FM – Decoded PS information from RDS signal;

RF – Indicator showing the RF signal level at selected antenna input;

VOL – Indicator showing the phones audio volume;

IFBW – Indicator showing the currently selected IF band-pass filter bandwidth.

Soft Buttons

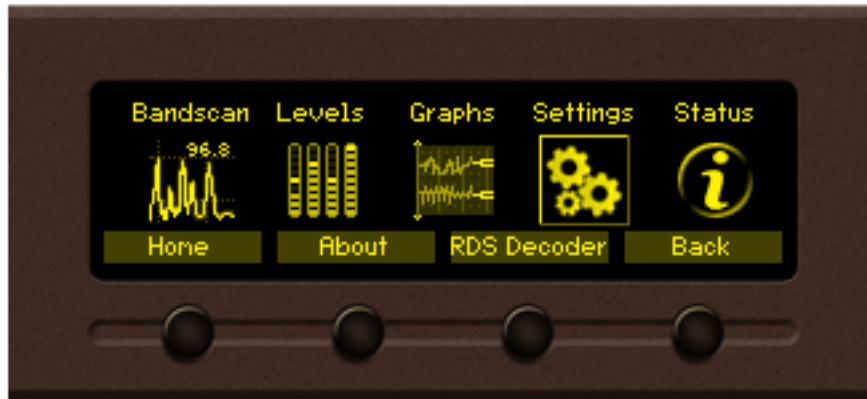

The soft buttons are located on the bottom of the OLED display making the direct transition from one page to another possible. The function of all Soft Button corresponds to the selected menu page. Most pages have the same or similar functional areas. The corresponding functions as Function, Menu Page, Parameter to be changed, etc., linked with the Soft buttons will appear as labels above them.

For example:

[Home] – Transition to home page will be made;

[About] – Will open a screen containing information on the manufacturer;

[RDS Decoder]

[Back] – Return to previous page;

NOTE: On some pages, the *Header* and *Soft button* area will disappear in order to reveal the content underneath.

How to change device parameters

Set-up menu title



Shows the path to the currently selected menu. Note that the parameter should be included in the settings menu title. For example: *Setup> Communication>HTTP> Port* is different from *Setup> Communication>FTP>Data Port*.

Navigation area

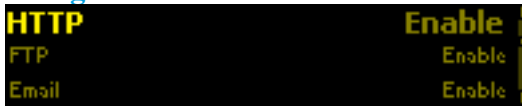

Selection of branches / parameters is made in this area. The selected item is highlighted. All parameters are listed on the left side of the navigational area. All parameter values are displayed on the right side against the parameter name. As the branches have no values associated, tree dots are shown instead. This indicates that a transition to a sub-menu is available.

Front panel buttons usage:

[OK] – Depending on the selected menu element can perform different actions:

- Menu branch – transition to selected sub-menu will be made;
- Menu parameter – when the name of a parameter is illuminated, pressing [OK] will highlight the value and switch to edit mode;
- Menu complex parameter (such as **Alarm**) – the parameter editor screen will be shown.

[UP] / [DOWN] – If edit mode is active, the value of the selected parameter will be changed.

Otherwise, are used for navigation through the menu;

[LEFT] / [RIGHT] – Change the selection when the parameter value is in edit mode;

[SB4] – Return one level up or cancel edit mode.

There are several parameter types available in DB7007. The way of editing depends of the parameter type. Every parameter type has its own editing rules.

Numerical parameter

Represents numerical value.

Example: The value *Frequency* can be changed in the range of **87.10 MHz** to **108.10 MHz** and *Frequency Step* of **10 kHz**, **20 kHz**, **50 kHz**, **100 kHz** and **200 kHz**.

Front panel buttons usage:

[UP] / [DOWN] – Change the value of the parameter with one step. The step value may vary depending on the selected parameter. The value always stays in permitted parameter range;

[OK] – Accept the changed value and exit edit mode;

[SB4] – will discard the value and cancel edit mode.

Enumerated parameter

Represent the selection of a value among set of predefined enumerated values.

Example: The value *De-emphasis* can be selected from **Flat**, **50µs**, and **75µs**.

Front panel buttons usage:

[UP] / [DOWN] – Cycle through the possible values;

[OK] – Accept the changed value and exit edit mode;

[SB4] – will discard the value and cancel edit mode.

IP address

Represents an IPv4 address.

Example: **Primary DNS** 192.168.001.001 , **Network Mask** 255.255.255.000

Front panel buttons usage:

- [LEFT] / [RIGHT] – Select edit marker position;
- [UP] / [DOWN] – Cycle through the possible values;
- [OK] – Accept the changed value and exit edit mode;
- [SB4] – Discards all changes and cancels edit mode.

IP port

Represents TCP or UDP port.

Example: **Manager Port** 162

Front panel buttons usage: Refer to IP address.

Date

Represent date from the calendar.

Example: **Date** 15-Jun-2012

Front panel buttons usage:

- [LEFT] / [RIGHT] – Selects previous/next segment from the date;
- [UP] / [DOWN] – Cycle through the possible values;
- [OK] – Accept the changed value and exit edit mode;
- [SB4] – Discards all changes and cancels edit mode.

Time

Represent time information.

Example: **Time** 02:00:00

Front panel buttons usage: Refer to Date.

Timer

Represents relative time interval.

Example: **Screen Saver** 2 min

Front panel buttons usage:

- [UP] / [DOWN] – Increments/decrements value with one step. The unit value will be changed automatically from seconds to minutes and vice-versa;
- [OK] – Accept the changed value and exit edit mode;
- [SB4] – Discards all changes and cancels edit mode.

String

Represents string.

Example: **User Name** **user**

Front panel buttons usage:

[LEFT] / [RIGHT] – Select edit marker position. If [RIGHT] button is pressed when the marker is at the last character, a space character will be added at the end of the string. When the [LEFT] button is pressed all trailing spaces will be removed;

[UP] / [DOWN] – Cycle through the possible values. Depending on the string context there is a limitation in the permitted char set. For example phone number string can contain only 1234567890+ and blank space characters;

[OK] – Accept the changed value and exit edit mode. Some strings, like e-mail addresses, must pass a validation check. If the validation fails, message box will appear. Press [OK] to dismiss the message. Note that edit mode will not be left.

For example:



If [OK] is pressed



If [OK] is pressed



[Insert] – Inserts blank space before the selected character:

User Name **us |r** – before;

User Name **us |er** – after.

[Delete] – Deletes the selected character:

User Name **us |r** – before;

User Name **us |** – after.

[Cancel] – Discards all changes and cancels edit mode.

MAIN SCREEN WORKING AREA

The Main part of the OLED Screen is where the information changes dynamically, depending on the selected working mode. The *Menu Screen* (shown below) appears upon pressing of the [OK] button. The DB7007's *Menu* Page contains selectable icons and software buttons for selecting modes and functions. Pressing [LEFT] and [RIGHT] arrow buttons will change the icon selection on the *Menu* page. The current selection is shown as rectangle focus frame around the icon. Pressing [OK] button will navigate to the corresponding page.



The following operating modes and pages can be selected using the navigational buttons:



– Bandscan page;



– Levels page;



– Graphs page;



– Settings page;



– Status page.

Operating Modes and Pages



Upon power-up and boot process of DB7007, the *Home* page will be displayed. Transition to *Home* page can be made from any page where [SB1] with this option is available. The home screen contains header area, the most important flags and attributes of the decoded RDS signal (if present) and currently selected frequency indicator. Press any soft button to enter the desired menu.

BANDSCAN PAGE

Select *Bandscan* icon from the Menu page and press [OK] to enter it. The last Bandscan data will be displayed.

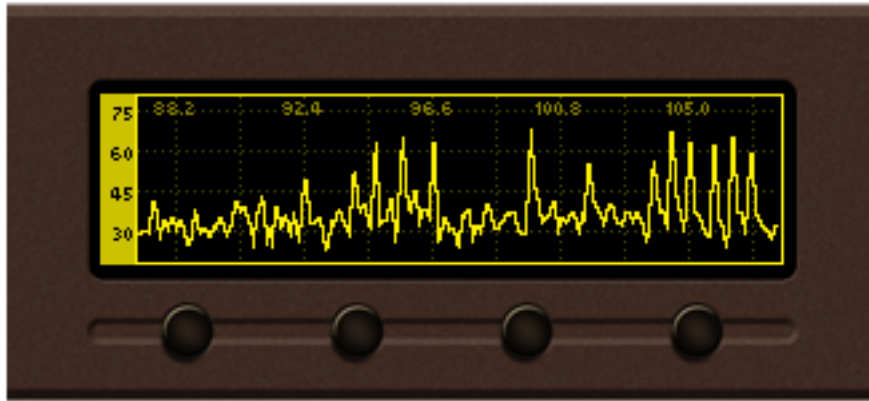

Empty grid will be displayed if no bandscan data is available at the moment.

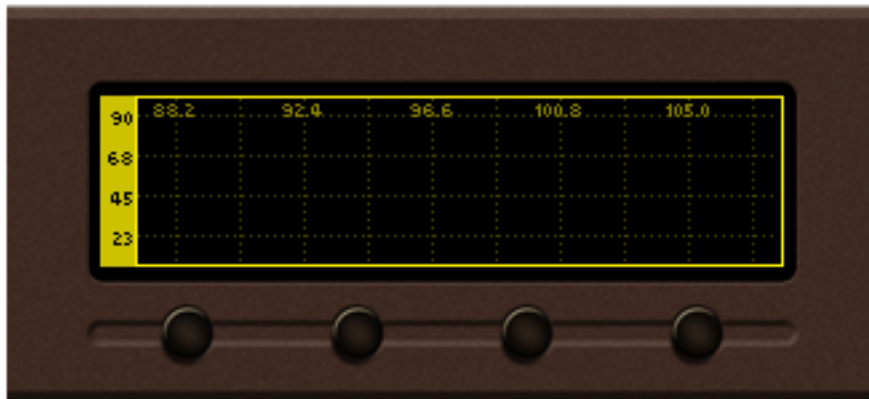

To ensure better reading of the data plot, the header area and the soft buttons labels will be hidden automatically short time after the soft button is released. Pressing a button will display the function labels again.

There are three control states in **Bandscan** page – Span control, Marker control and Parameter control. The states can be identified by the labels of the soft buttons. If the labels appear as shown on the picture below, the page is in Marker control state.

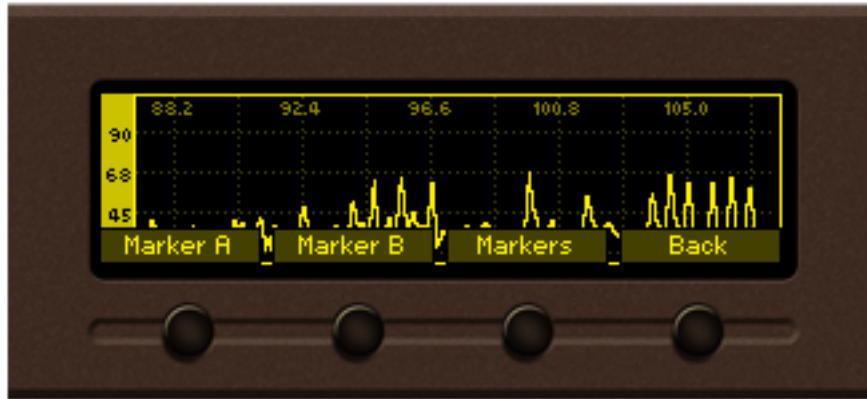

For example: When the following menu is selected pressing [SB3] will change the screen from *Marker* to *Span* control and vice-versa. All Soft buttons labels will change according to the sub-menu. The control state of the page will change upon every [SB3] pressing.

Pressing the [OK] button either in Marker or Span control state will make transition to Parameter control state. The screen will be visible until the [OK] button is pressed again or the timeout of 2 seconds elapses.

Diagram representing the control state transitions:

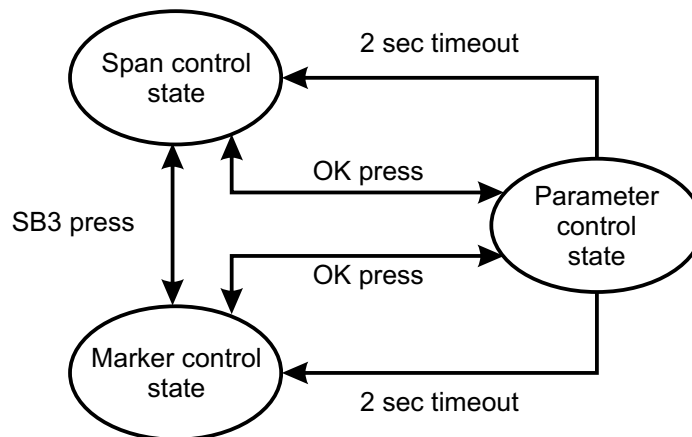

Span control state

[SB1], [SB2] and arrow buttons control the Span of the data plot. Depending on the Span control state the soft buttons have different usage.

X Span – [SB1] cycles through available span values for X axis of the data plot. The possible values vary between **3 MHz** and **21 MHz** in **1 MHz** increments. Note that changing X span may also change the center frequency in order to keep data plot in bounds. When a key is pressed next span value will be selected and displayed on the screen.

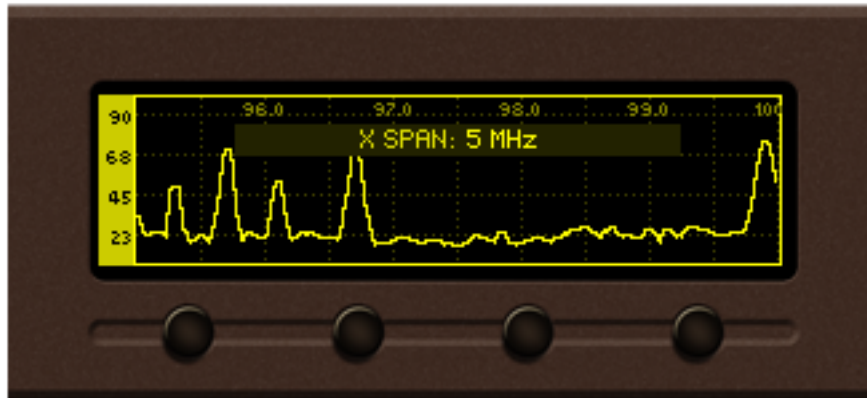

5MHz X span is selected

Y Span – [SB1] cycles through available span values for Y axis of the data plot. The possible values are **30 dB μ V**, **60 dB μ V**, **90 dB μ V**, and **120 dB μ V**. Note that in order to keep the data plot in bounds changing Y span may also change the Y reference. When the button is pressed new value will be selected and displayed on the screen.



120 dB μ V Y span is selected

[LEFT] / [RIGHT] buttons – change the center frequency of the data plot on **500 kHz** increments. The center frequency permitted values depend on the currently selected X span. The selected center frequency value is briefly displayed on the screen.

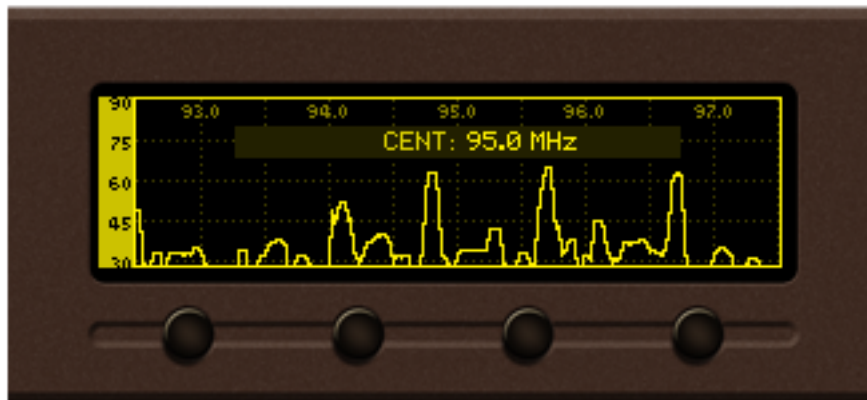

95 MHz center frequency is selected

[UP] / [DOWN] Buttons – changes Y axis reference (the value for the bottom of the Y scale). Permitted values vary from **-20dB μ V** to **110dB μ V** in **10dB μ V** increments. The upper limit of the Y reference depends on the currently selected Y span. Upon selection, the Y reference is briefly displayed on the screen.

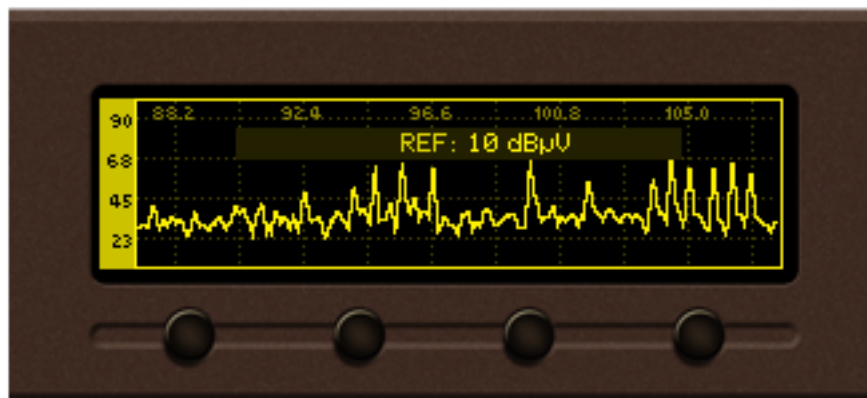

10 dB μ V reference is selected

Marker control state

Two markers, named “A” and “B” are available in Bandscan page. [SB1], [SB2], [LEFT] and [RIGHT] buttons control the visibility and position of the Markers.

Buttons [Marker A] / [Marker B] control the markers appearance. According to your needs the markers can be:

- hidden – marker is not visible;
- shown – marker is visible but not selected;
- selected – marker is visible and selected.

When markers “A” and/or “B” are visible (shown or selected) a readout about X and Y axes will appear on the left side of the data plot. If both markers are visible, the differential “Marker B minus Marker A” value will be displayed at the bottom left of the screen.

The selected marker is represented as highlighted, dashed line; marker’s readout is also highlighted. Only one marker at a time can be selected. If only one of the markers is visible, it will be always selected.

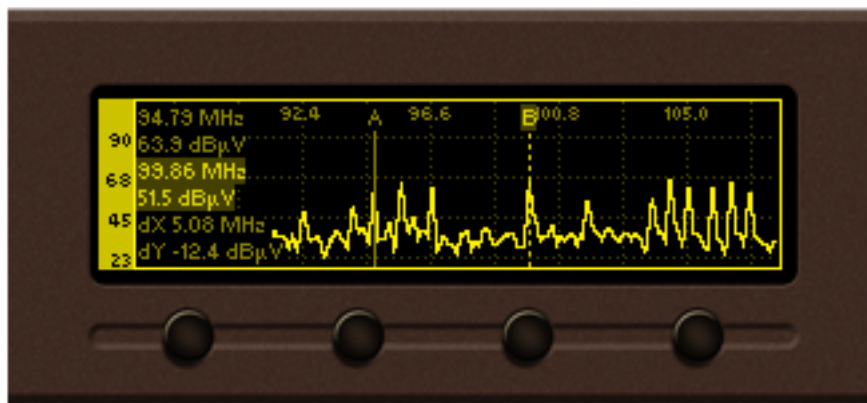

Marker A is shown, Marker B is selected

Following is a diagram explaining the transition between these states:

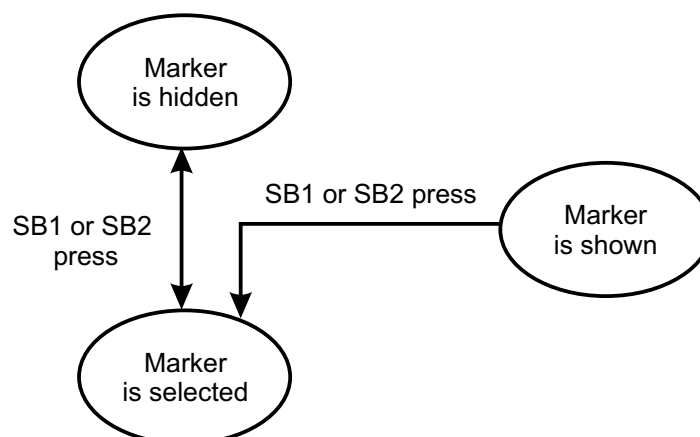

[LEFT] / [RIGHT] Buttons – move the selected marker to the left or right with one screen pixel increment.

NOTE: The step resolution of marker movement depends from the selected X span.

[UP] / [DOWN] Buttons –are used to change the Y reference like in Span control state.

Parameter control state

Parameter control state allows specific parameters to be set before starting the bandscan.

[OK] – show/hide parameter control

[LEFT] / [RIGHT] – cycle through the available parameters.

[UP] / [DOWN] – change the value of the selected parameter.

The name and value of the selected parameter appears briefly on the data plot.

NOTE: Parameter control state will automatically disappear from the screen if no button is pressed for 2 seconds.

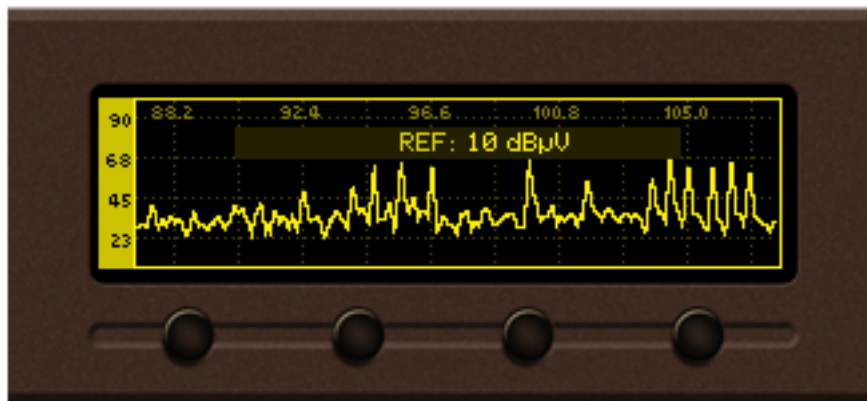

Bandscan page parameters

Bandscan: Start / Stop – Used for starting/stopping of the bandscan process. Information about the progress will be displayed on the right bottom corner of the data plot. Upon completion, the Bandscan parameter value will be automatically set to **Stop**.

Running bandscan can be stopped manually by setting the Bandscan parameter value to “Stop”.

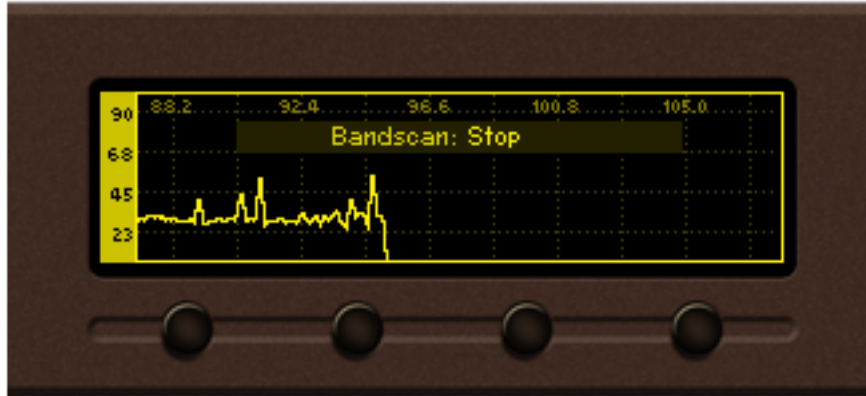

Start Frequency: – set the start frequency of the bandscan.

End Frequency: – set the end frequency of the bandscan.

Step: 10, 20, 50 or 100 kHz – set the step increments of the band. Small steps lead to higher resolution but slower bandscan;

RF Input: Antenna 1/Antenna 2 – select the antenna input to be used during bandscan;

Pressing [SB4] in Bandscan page will lead back to the previous page.

NOTE: Leaving the page will not stop the bandscan process. The process will continue until it is finished or the Bandscan parameter value is set to “Stop”.

LEVELS PAGE

Enter the Main Menu page and select the Level icon, press [OK] button to enter the menu. Levels page shows bar graph representation of the different signals, measured by DB7007. The parameters are divided into groups. Each bar graph displays the low, average and high values of the signal. The number in the center below represents the average value. The shaded color number, placed on the left and right bottom edges, denotes the measurement range of the signal. Measurement units and name of the signal are written above the corresponding bar graph.



Group 1. RF carrier related parameters

The **RF** level at the selected antenna input is measured in **dB μ V**. The RF attenuation is included in the level calculation.

The **Frequency offset** of the RF carrier is measured in **kHz**. This signal measures the misalignment between the modulation and demodulation frequency. As the misalignment is expected to be small, a large offset will indicate disturbance (for example adjacent channel breakthrough). The **Frequency offset** is measured with better accuracy if there is no modulation of the carrier. The usable range depends on the selected IF filter bandwidth.

The **Multipath** reception level is measured in % (percents). The multipath detector measures the amplitude fluctuations of the signal. The FM signal is broadcasted with a fixed level; therefore the level fluctuations will indicate degraded signal quality. At multipath conditions, large level fluctuations can be measured. To achieve better re-broadcast, install the antenna at the reception point with the lowest multipath level.

IF Bandwidth – Shows the current IF filter bandwidth.

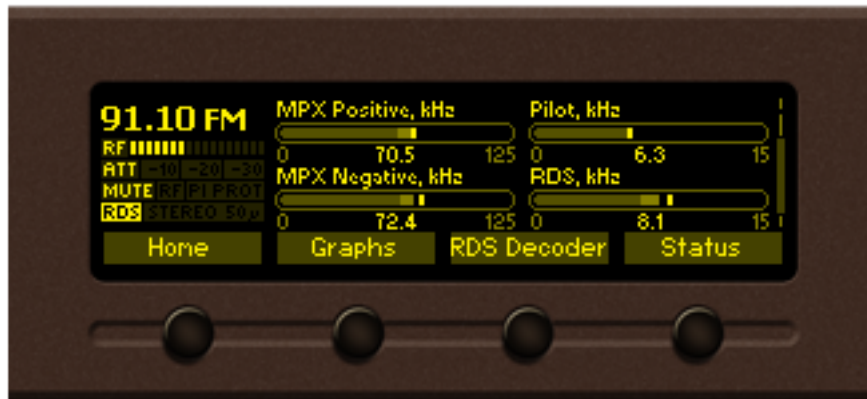

Group 2. Stereo multiplex related parameters

MPX Positive and **MPX Negative** – These bar graphs represent the positive and negative deviation component of the MPX signal.

Pilot – Represents the deviation caused by Pilot tone injection. Our practice shows that for best results the pilot deviation should be about **7.5kHz** of the total deviation of the RF carrier.

RDS – Represents the deviation caused by RDS subcarrier. Our practice shows that for best results the RDS deviation should be about **5kHz** of the total deviation of the RF carrier.



Group 3. Audio related levels

Left and **Right** audio channels



Group 4. Reception quality related levels

Ultrasonic Noise – Indicates the MPX signal amplitude in the approximate bandwidth of **80 kHz – 150 kHz**.

Stereo Blend – A value of **100%** indicates that no reduction is applied. The level of stereo blending depends on the following input signals: RF Signal Level, Multipath, Ultrasonic Noise and Pilot tone deviation.

High Cut – Audio disturbance effect is mostly present in the high frequencies. A value of **100%** indicates that no “high cut” is applied. The applied High Cut level depends on the following input signals: RF Signal Level, Multipath and Ultrasonic Noise.

Soft Mute – If a disturbance is present in the received signal, the perceived effect can be reduced by attenuating the audio signal. The reduction of audio volume is called “soft mute”. A value of **0%** indicates that no “soft mute” is applied. Soft Mute depends on the following input signals: RF Signal Level, Multipath and Ultrasonic Noise.

GRAPHS PAGE

Enter the Main Menu page and select the Graphs icon, press [OK] button to enter the menu. Graph page represents the value of a measured signal over time. The X axis of the data plot area represents the elapsed time in seconds. New peak value sample is added to the data graph every 125ms. Up to 20 seconds of measurement history is available for each signal. The newest sample is on the right side of the graph. The current signal name and measurement unit are displayed in the top left corner of the data plot.

A bar graph indicator, placed on the right part of the screen, is used to display the instantaneous value of the selected signal. The low, average and high values of the measured signal are represented in shaded color. The following signals can be selected:

- *RF level* – from **-10dB μ V** to **110dB μ V**;

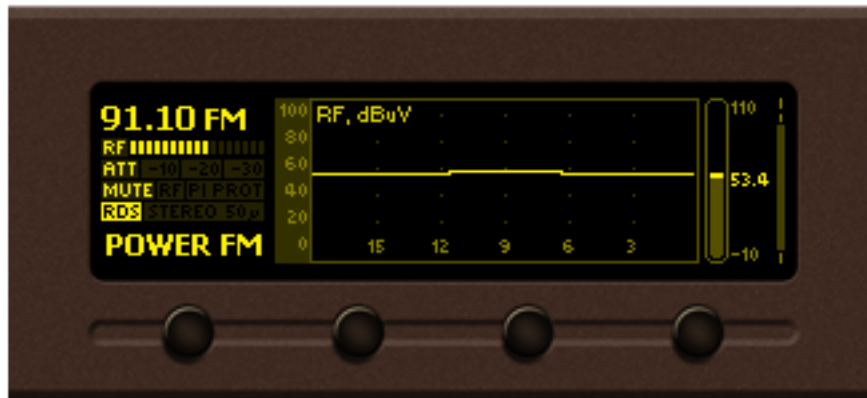

- *Multipath* level from **0%** to **100%** (percent);

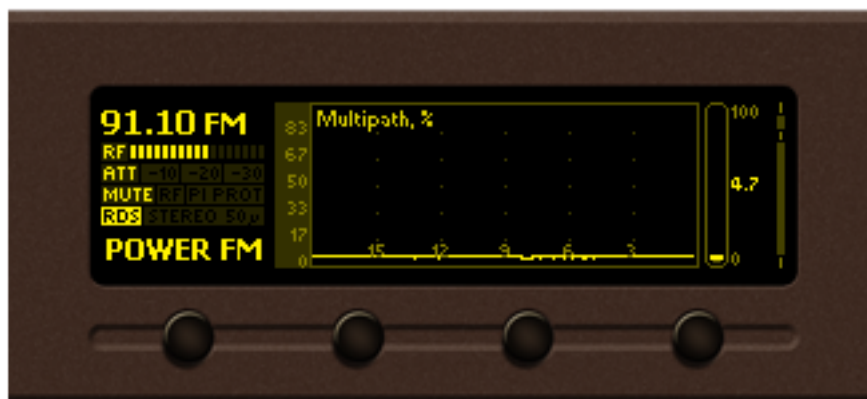

- *MPX Total* deviation from 0 kHz to 125 kHz;

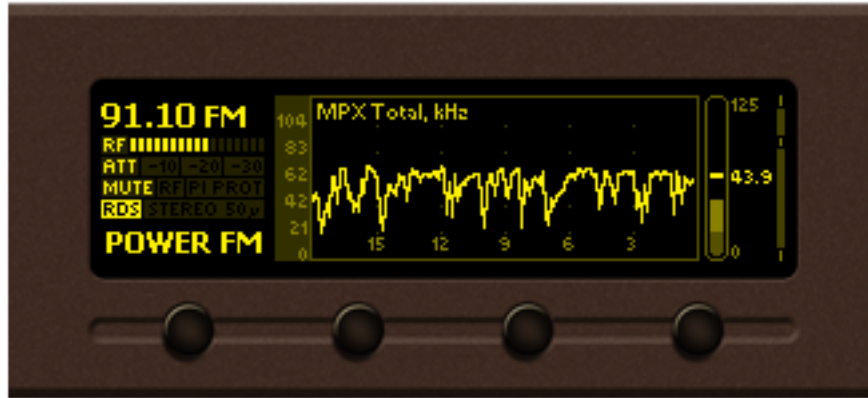

- *Pilot* level from 0 kHz to 15 kHz;



- *RDS* level from 0 kHz to 15 kHz;

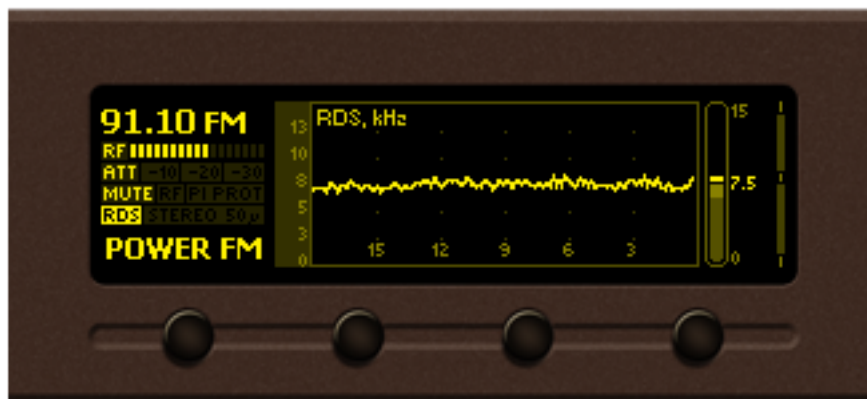

- *Left* audio level from -60 dB to 10 dB;

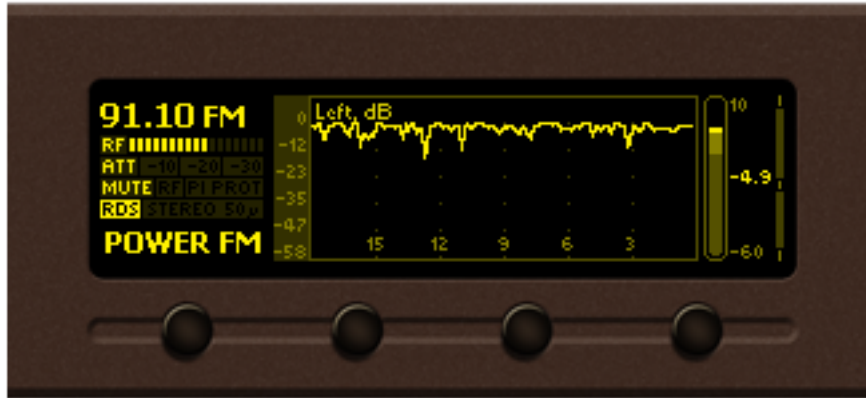

- *Right* audio level from -60 dB to 10 dB;

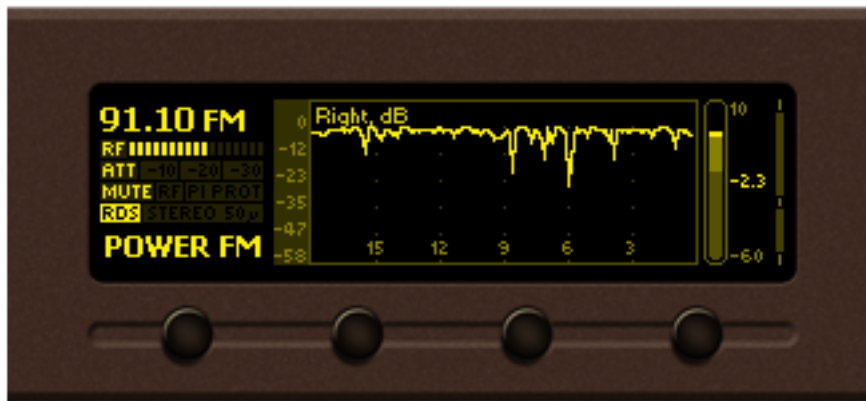

- *Stereo Blend* from 0% to 100%;



- *Frequency Offset* of the RF carrier from **-50 kHz** to **50 kHz**;



- *Temperature* in the device from **-10°C** to **90°C**.



SETTINGS PAGE

Enter the main menu page, select *Settings* and press [OK].

The *Settings* menu is organized into a hierarchical tree menu and all similar parameters are grouped into sections (branches).

Main Station



The *Main Station* is the main audio source of DB7007. From here you could set the *Frequency*, *Attenuator Ant 1*, *RF Loss* and *PI Protection* settings.

Backup Station



From here you could set the *Frequency*, *Attenuator Ant 2*, *RF Loss* and *PI Protection* settings of the *Backup Station*.

Tuner



These settings provide all the needed adjustments to the algorithm which DB7007 processes the signal. From here the settings applied to the *Frequency Step*, *De-emphasis*, *RDS Mode*, *Audio Processing* and *Average and Peak* (used for setting the indicators response times) could be applied.

Audio Processing considered – If set to **Auto**, the corresponding parameter will depend on the quality of the received signal (RF Level, Multipath, and etc.). If any changes in the signal are detected, the unit will automatically adjust to the correct values.



For further information, please refer to [“Tuner Settings Screen” on page 75](#)

Backup

Once silence on the current audio source is registered, the DB7007 will automatically switch to the next available backup audio source. From here you could set the backup sources priority and set *Audio Loss Threshold*, *Audio Loss Timeout*, *Audio Recover Th.*, *Audio Recover Timeout*, *Stream Client*, *RTP* and *Backup Files Order*. Based on these settings, the DB7007 will make sure your station has audio 24/7.



MPX

The Stereo MPX is signal used for FM Stereo broadcasting and represents a complex combination of the following signals:

- Sum of the left and right audio channels occupying the band from 0 to 15kHz;
- Difference signal (Left minus Right) located in the band 23-53kHz;
- Pilot tone at exactly 19 kHz;
- RDS signal, used for transmitting text and other data, may also be added. It occupies a narrow band around 57kHz.



DB7007 has a built-in stereo generator and Radio Data Systems (RDS/RBDS) encoder. The amount of each signal contained in the final MPX signal is called injection level.

MPX out Configuration



Settings> MPX>MPX Source

There are three types of MPX signal that you can choose from:

1. **RAW MPX** – Directly modulated by your station RAW MPX without any further processing;
2. **Stereo & RDS Gen** – Generated by the internal stereo and RDS generators;
3. **Calibration Tone 400Hz** – used to adjust the transmitter MPX input.

NOTE: Raw MPX is used only when Main Station is the current audio source. Stereo & RDS Gen is used automatically for all other audio sources. Calibration Tone is active regardless of the current audio source.

Stereo Generator

Settings> MPX> Stereo Mode

The composite multiplex signal, including the pilot tone, is generated through the build-in Stereo generator. The stereo generator can operate in two modes - **Stereo** and **Mono**. In order to overcome the noise of the treble frequencies the Emphasis can be set to **Flat**, **50µs** or **70µs**.

Injection levels



The MPX signal is a combination of Audio, Pilot and RDS Signal. This option allows you to adjust the amount of each signal included in the MPX. The recommended and default values are: **0dB Audio gain**, **7.5kHz Pilot** and **5.0kHz RDS**.

MPX limiter



Settings> MPX

The regulatory authorities, in some countries, require the total MPX Power not to exceed **0dB**. Therefore, DB7007 has a built-in MPX ITU limiter that restrains the deviation below the predefined threshold. The default threshold is **0dB**.

RDS



Settings> RDS

The use of RDS/RBDS Encoder will allow branding of your station and will enable the transmission of the *Program Service name (PS)*, *Program Identification code (PI)*, *Traffic Announcement (TA)* and other useful features.

The RDS/RBDS Encoder has four different working modes:

1. **Original** – Re-broadcast of the original RDS/RBDS data received from the station;
2. **Orig/Local fallback** – Upon loss of the Original RDS/RBDS the Local data will be used;
3. **Replace with local** – User-defined combination of the original and local RDS/RBDS data. One or more values from the following can be modified: *Program Identification Code(PI)*, *Program service(PS)*, *Radio Text(RT)*, *Alternative Frequencies(AFs)*, *Program type(PHY)*, *Decoder Identification control code (DI)*, *Music/Speech (M/S)*, *Traffic program code(TP)*, *Traffic Announcement(TA)*;
4. **Local only** – User-defined RDS/RBDS data.

NOTE: Original RDS data is taken from the active radio station, either Main or Backup. If one of the other audio sources is currently active, RDS Local values are in use, regardless of the RDS Data Source setting.

Communication

Grants you access to the **General Setup** (to enable or disable the functions included in the menu), **General Setup**, **Ethernet**, **SNMP**, **HTTP**, **FTP**, **SNTP**, **Email**, **Streamer**, **Syslog**, **UECPTCP Server**, **UECP UDP Relay**, **GSM Modem**.





Security

From here you could set-up, change or disable the password protected access to the **Front Panel** or **Remote access**.



Keyboard lock



To prevent unauthorized local access, the DB7007 offers password protected keyboard locking. By default the keyboard is unprotected. To enable this function, using the front panel navigational menu, go to **Setup> Security> Front Panel**, then press [OK] and **Enable** the **Access Control** function. Set the preferred 5 digit password and **Access Timeout**. Once the keyboard lock function is enabled, every attempt to use it will require a password:

ENTER PASSWORD: 0****. Access will be denied upon false entry.

Keyboard unlock

If the keyboard unlock function has been activated by mistake, try to unlock it using the default password **01234**. In order to deactivate the code protection, once the front panel menu is unlocked follow the menu path **Setup> Security> Front Panel> Access Control** and then select **Disabled**. If you do not manage to unlock the front panel with the default password, nevertheless whether it has been changed intentionally or not, DB7007 should be returned to its factory defaults in order for the password security to be disabled.

NOTE: The password consists of 5 digits. The leading zeroes are not shown in the menu, but should be specified when entering the unlock password. For example, if your password is 123, when entering the password 00123 should be written.

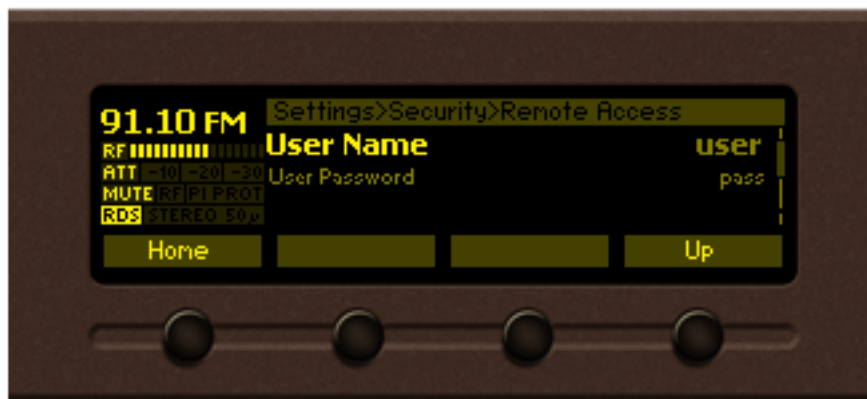

Alarms

Is a special parameter type with its own dialog editor. Each alarm parameter is composed of the following sub-parameters:

- **Low threshold** – the lower alarm limit of the measured signal. If the value stays below this limit for predefined time “low alarm” event will be generated;
- **High threshold** – the higher alarm limit of the measured signal. If the value stays above this limit for predefined time “high alarm” event will be generated;
- **Trigger time** – waiting time before a “low alarm” or “high alarm” event is generated;
- **Release time** – waiting time before an “Idle alarm” event is generated;
- Set of notification channels – In case of alarm, maintenance staff will be immediately alerted via **SMS**, **E-mail**, **SNMP** or **GPO**, which allows technicians to restore the normal service as soon as possible.



Depicted above is the structure of the alarm editor dialog for the: **RF Alarm**, **MPX Alarm**, **Pilot Alarm**, **RDS Alarm**, **Left Alarm**, **Right Alarm**, **Temperature Alarm**, **Fan Speed Alarm**.

The bar graph indicates the signal range of the alarm. The highlighted area represents the permitted signal value range. If current signal value (pos. 4) is in this range, no alarm event will be generated. Basic elements of the alarm editor dialog:

1. Lower limit of the alarm range;
2. Low threshold value;
3. Measurement unit;
4. Current value of the signal;
5. High threshold;
6. Higher limit of the alarm range.

Alarm edit dialog, front panel buttons usage:

[LEFT] / [RIGHT] – Selects previous/next sub-parameter of the alarm.

[UP] / [DOWN] – Change the value of the selected (highlighted) sub-parameter. The value always stays in the permitted parameter range. Low threshold value cannot exceed the high threshold and vice-versa;

[OK] – Accept the value and exits edit dialog;

[SB2] – Toggles ON/OFF the low alarm generation;

[SB3] – Toggles ON/OFF the high alarm event generation;

[SB4] – Discards all changes and cancels edit mode.

GP Outputs

This subsection of the menu is intended for set-up of the GPO's functions, type, and pulse level.



Audio/MPX Outputs

Allows you to adjust the *Phones Volume*, *Audio Volume*, *GSM Volume*, *MPX Volume* and to **Disable/ Enable** the *Digital Output* of DB7007.



Device

Allows you to change the name of the device, set-up the **Date/Time**, change the default settings of the OLED graphical display (menu **Front Panel**), specify the **Weblog Max Days** and finally to return the device to its **Factory Defaults**.



DB7007's tuning range is user selectable, 87.1-108 MHz (CCIR), 65-74 MHz (OIRT), 76-95 MHz (Japan). Changing/selecting the Region setting, will modify all tuner frequencies so that they could be within the FM band limits of the region chosen. This includes all Presets and Logger Channel frequencies.



STATUS PAGE

The basic/general information on the device is found here:

Device – Model, Serial number, Firmware version in use, Calibration, Storage capacity;



IP address – IP, Network Mask, Gateway, Primary DNS, Secondary DNS



Alarms – the current alarm status is available here.



[RDS DECODER] PAGE

Pressing [RDS Decoder] will open the RDS decoder page. Where the decoded RDS information could found. The [RDS Decoder] soft button is available on both - the main screen and menu.

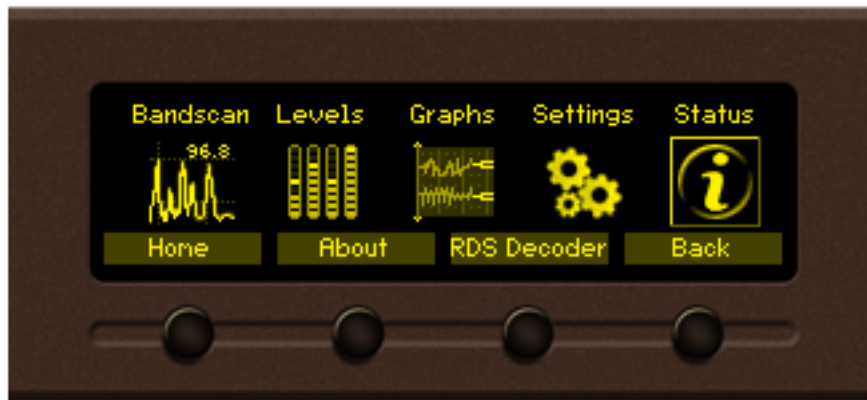

RDS/RBDS Page Main view



RDS/RBDS RAW Data view



RDS/RBDS AF list view



RDS/RBDS Statistics view



RDS/RBDS Sequence view

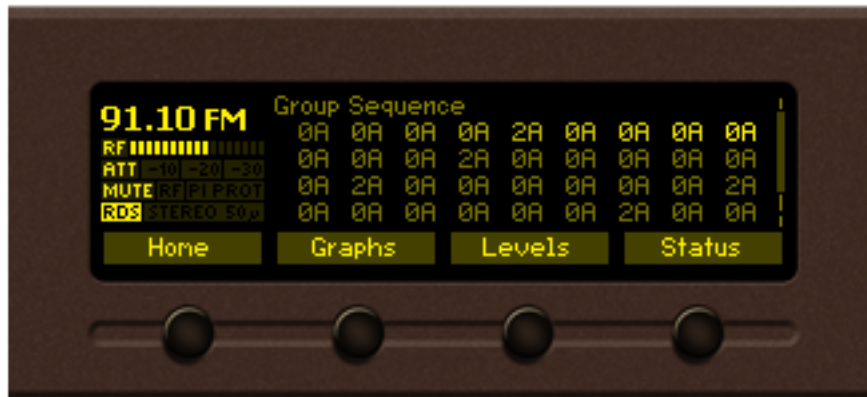

WEB Interface

DB7007 is also controlled through a built-in web server. A standard web browser can be used to monitor its status or to make some adjustments. There are two options for access to the WEB interface of DB7007:

- via a standard WEB browser by specifying the device's IP address (the IP address should be manually identified first);
- via the "Network discovery" option.

MANUAL IP ADDRESS IDENTIFICATION

Connect the device to a local network or to the Internet by the applied LAN cable. Through the front panel navigational menu pressing the [OK] button will enable you to enter the device main menu.

Using the [RIGHT] navigational button find the *Status* section located at the end of the menu. Press the [OK] button to enter the *Status* section. Via the front panel navigational menu press the [DOWN] button.

This operation will visualize the screen containing information about the IP address of the device. Open a new WEB Browser and enter the device IP address in the address field then press [Enter].

NOTE: Due to the inability of some WEB browsers to read the IP address format displayed on the screen of the device, the numbers included in the IP address must be written without the leading zeros. For example: 192.168.020.095 must be written as 192.168.20.95

A window that requires username and password will appear. Default values being Username: user or admin, Password:pass

NETWORK DISCOVERY

This is a network setting that defines whether your computer can see (find) other computers and devices on the network and whether other computers on the network can see your computer. By default, Windows Firewall blocks network discovery but you can enable it.

1. Open Advanced sharing settings by clicking the Start button, and then on "Control Panel". In the search box, type "network", click "Network and Sharing Center", and then, in the left pane click "Change advanced sharing settings";
2. Select your current network profile;
3. Click Turn on network discovery, and then click save changes.

NOTE: If you're prompted for an administrator password or confirmation, type the password, provide confirmation or contact your system administrator.

If you have already enabled this function on your computer DB7007 will be automatically added to the Device list section. The device will be ready for usage and no additional adjustments will be required except **user name** and **password**.

ACCESS

DB7007 provides you with a protected access to the device settings. You can choose between two types of log in:

1. As an ADMINISTRATOR – it will give you full control over the settings (username: `admin`, password: `pass`);
2. As a USER – this type of log-in will allow you to monitor the device and to choose different stations without applying settings (username: `user`, password: `pass`).

In order to make the necessary adjustments to the device, please log in as an ADMINISTRATOR.

MAIN SCREEN

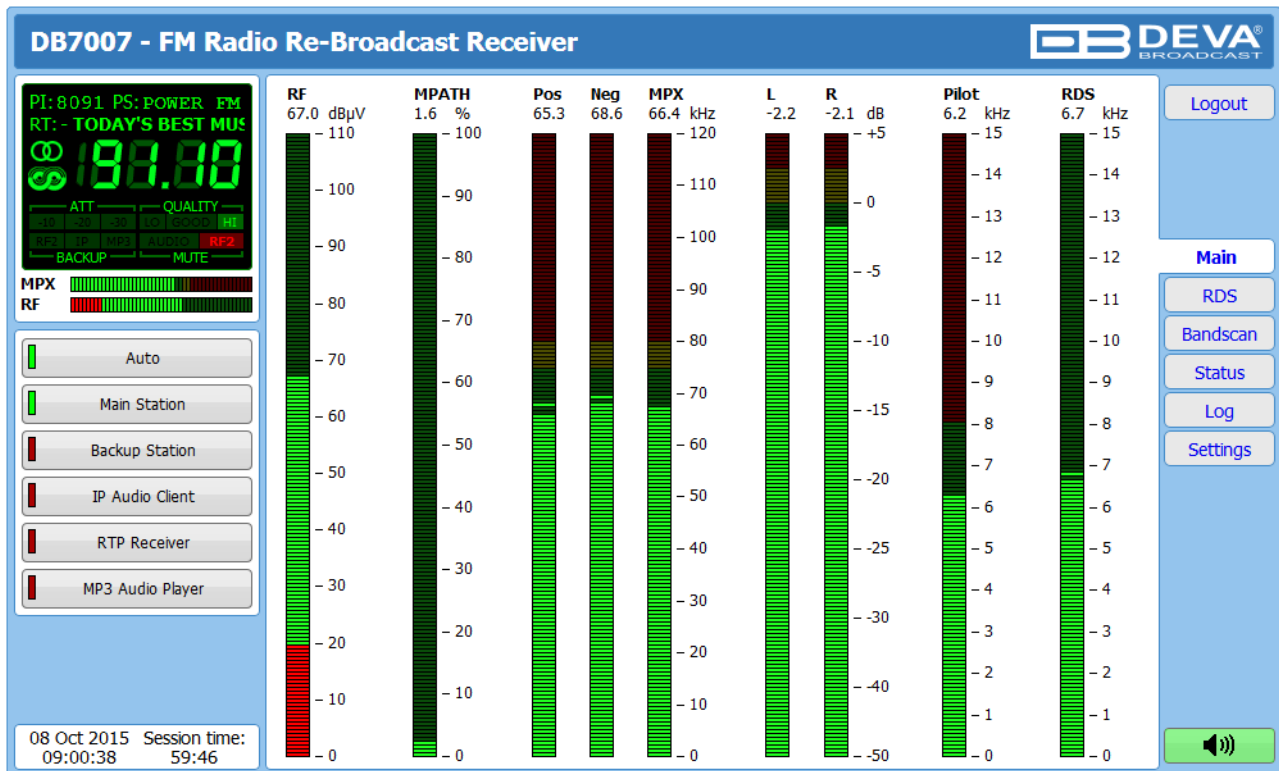

The Main Screen of the WEB Interface shows all the mandatory parameters represented as LED readings.

On the top left corner of the screen is placed the online representation of DB7007's front panel OLED graphical display. It contains information on all mandatory parameters and applied settings. This is a constant part of the WEB interface windows, hence allowing easy access to the most important information.

Below are the interactive buttons, used for quick selection of DB7007's preferred working mode. In case the Backup source is activated, you will be notified immediately via one of the possible methods (E-mail, SMS, SNMP and GPO) and with a message alerting that the backup source is on-air. Depending on the activated backup source, additional section containing information on the signal status will appear on the bottom part of the screen (as depicted below).

When Backup Station is activated as a backup source, the main control window will look as follows:

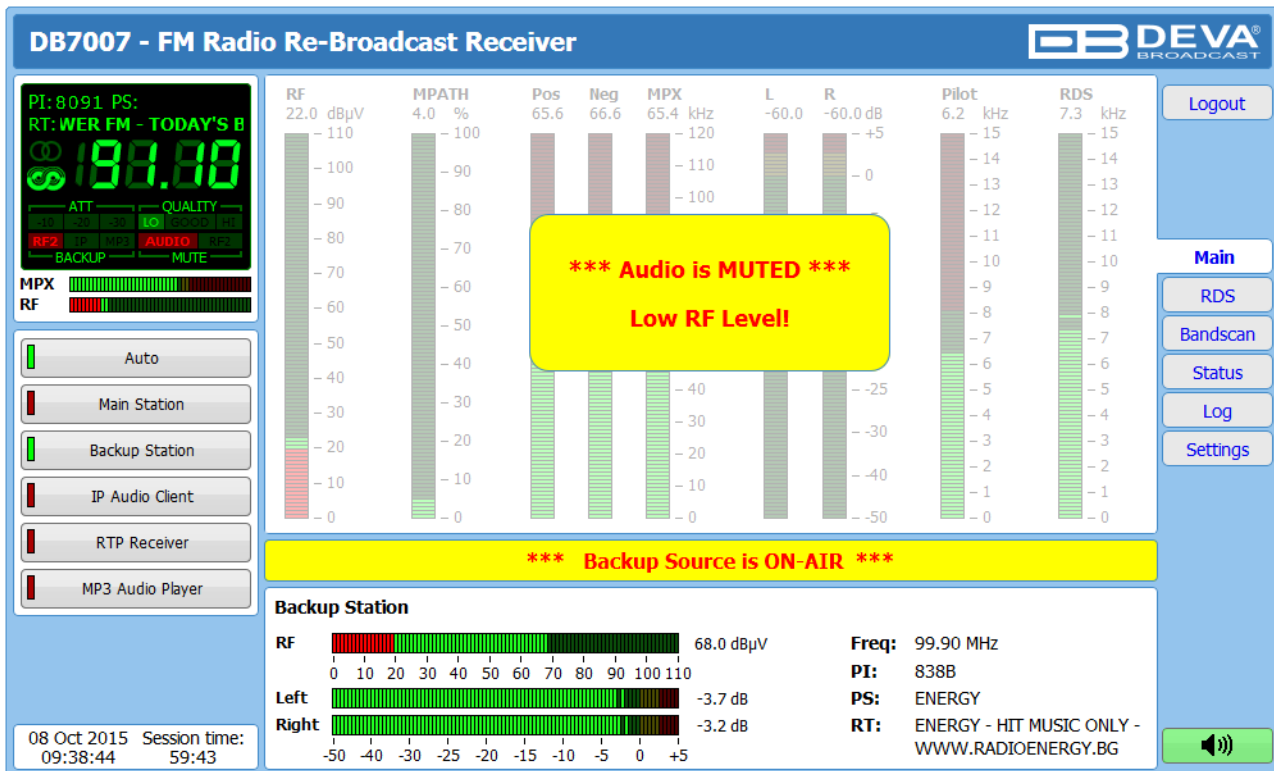

When the IP audio Player is activated as a backup source, the main control window will look as follows:

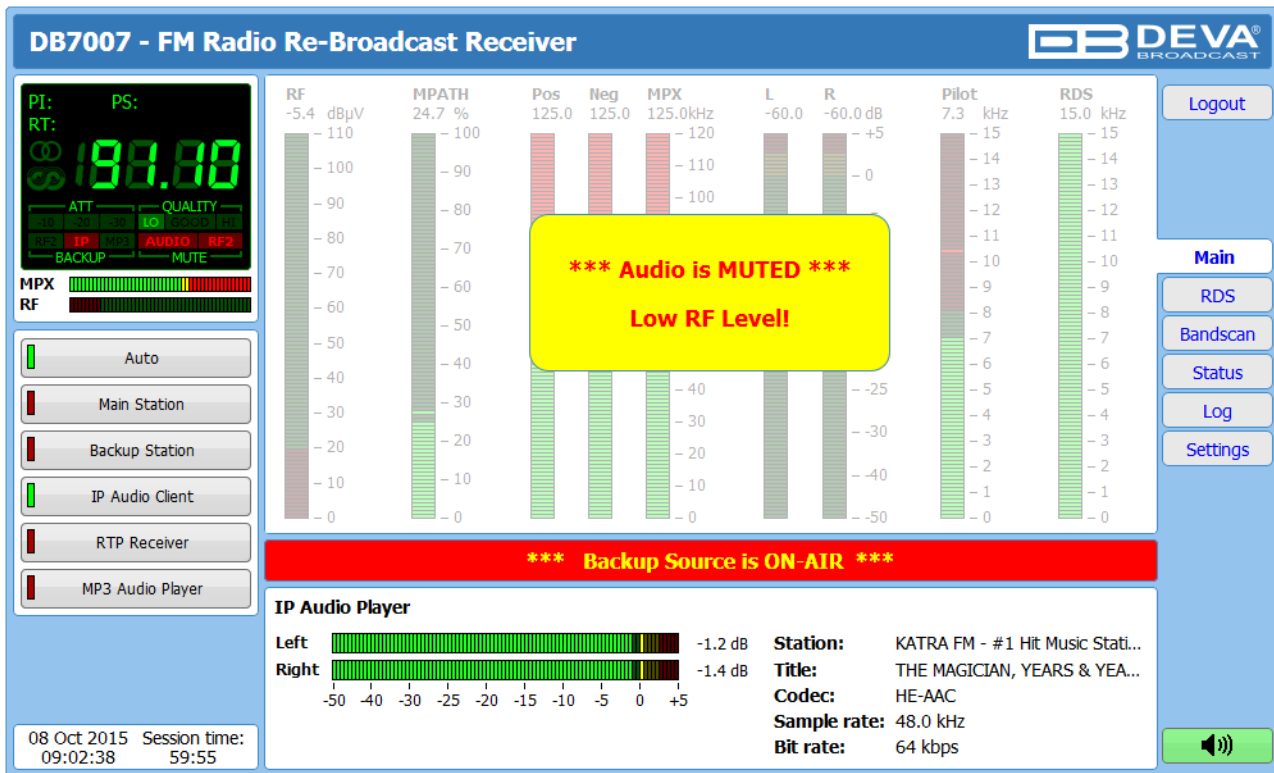

The section contains information on the Left & Right Audio Levels, station's name, title, codec, sample and bit rate.

When the RTP Receiver is activated as a backup source, the main control window will look as follows:

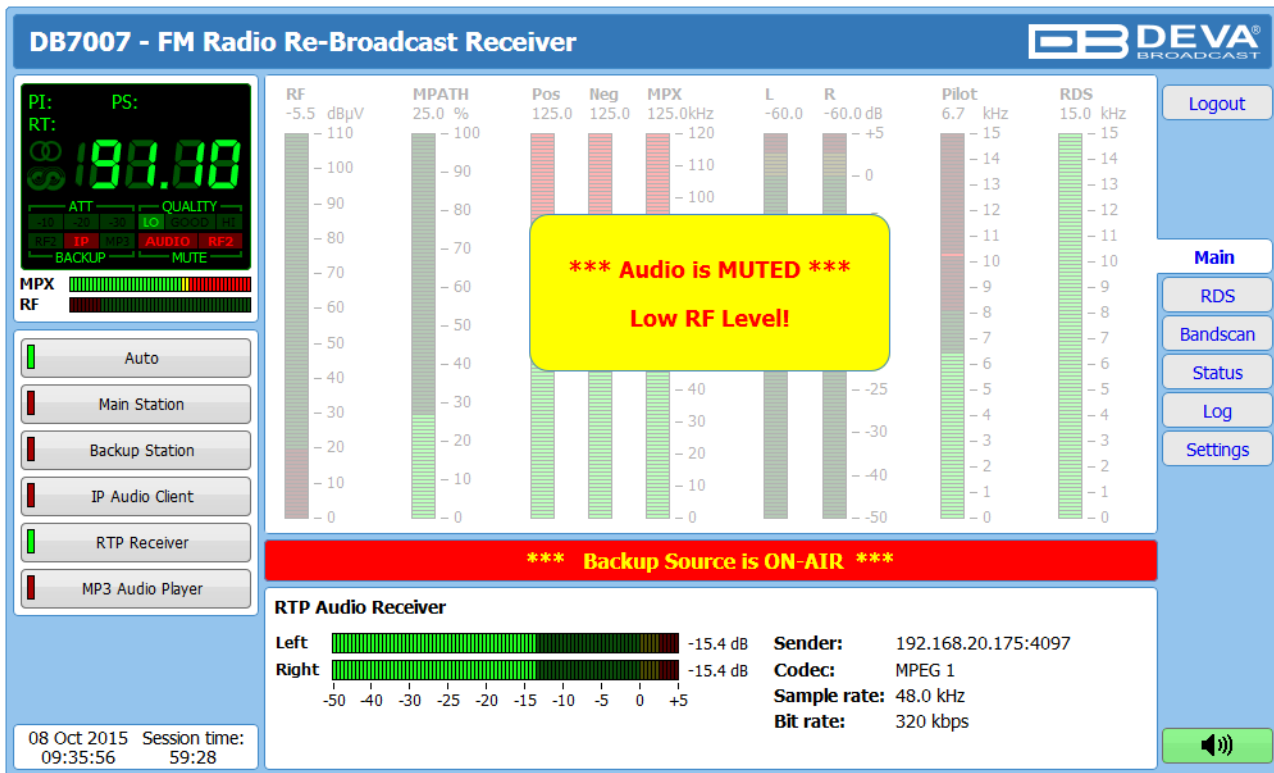

The section contains information on the Left & Right Audio Levels, sender, codec, sample and bit rate.

When the MP3 Audio Player is activated as a backup source, the main control window will look as follows:

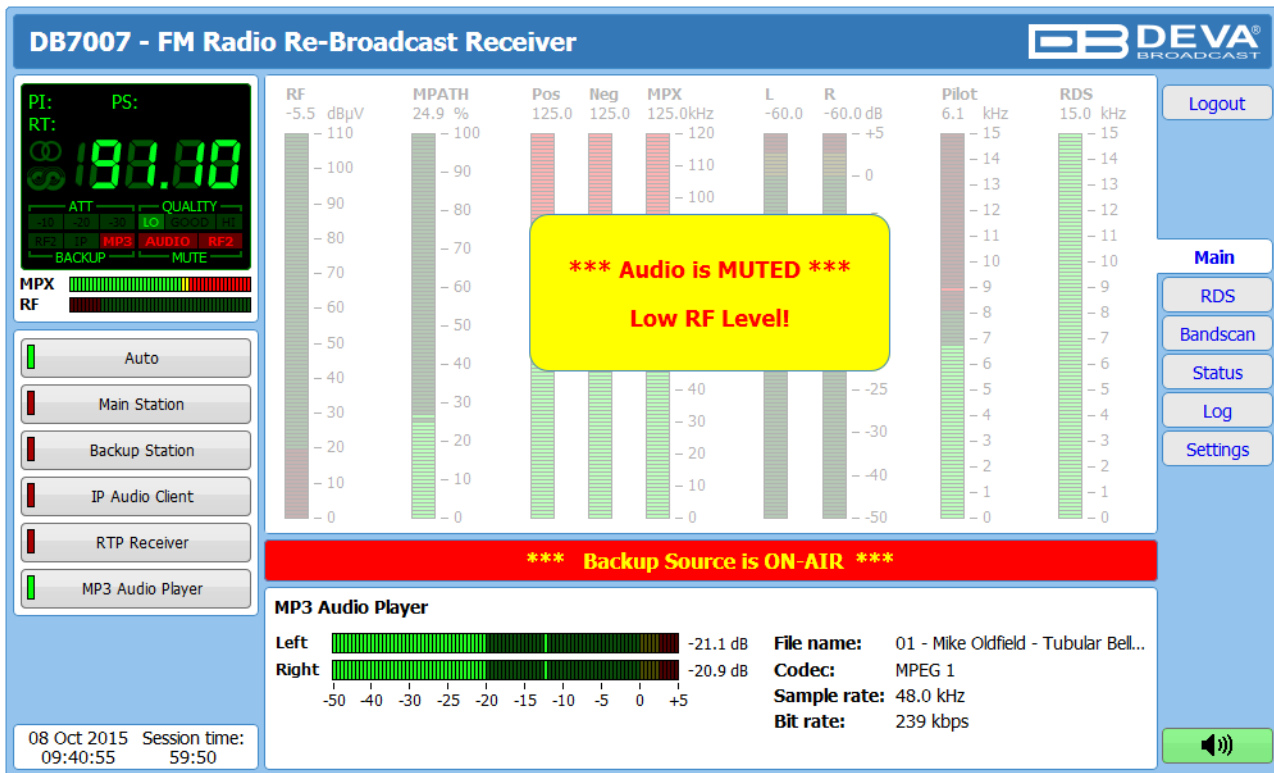

The section contains information on the Left & Right Audio Levels, file name, codec, sample and bit rate.

RDS/RBDS SCREEN

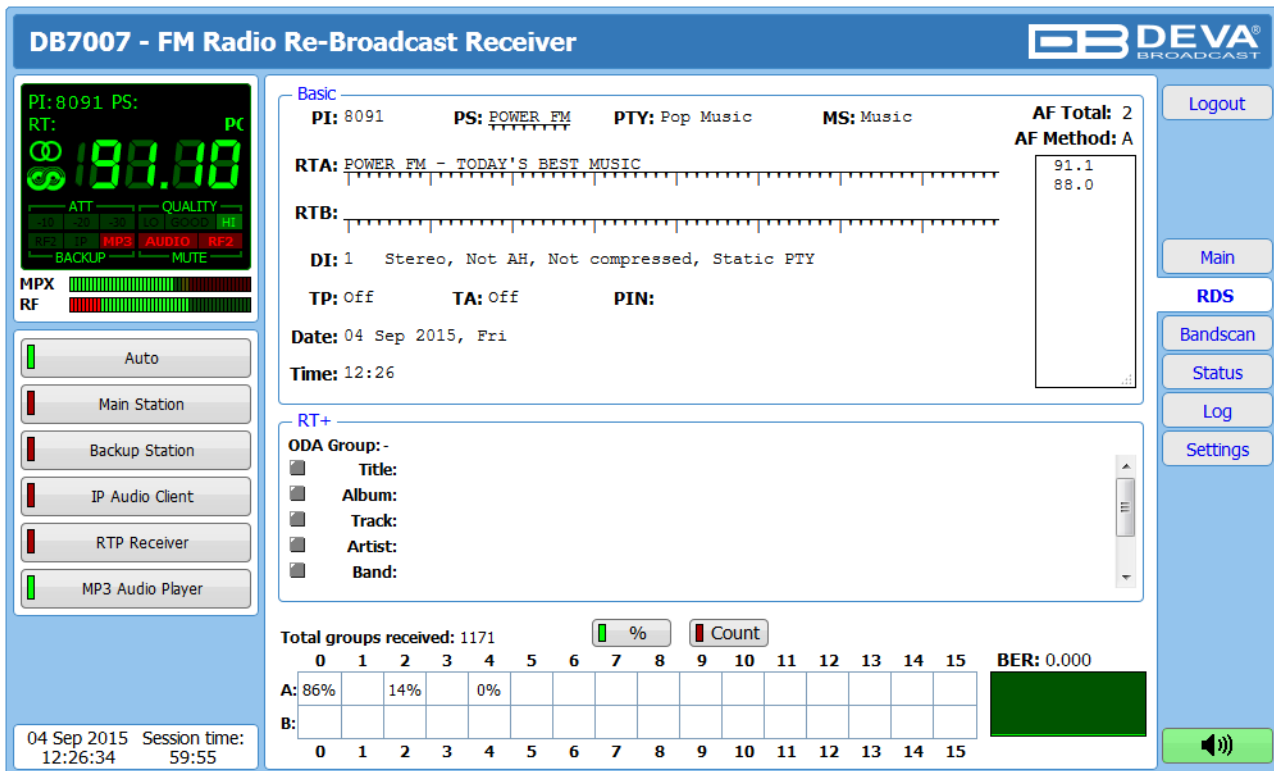

DB7007 - FM Radio Re-Broadcast Receiver

Basic

PI: 8091 PS: POWER FM PTY: Pop Music MS: Music AF Total: 2
 AF Method: A

RTA: POWER FM - TODAY'S BEST MUSIC

RTB:

DI: 1 Stereo, Not AH, Not compressed, Static PTY

TP: Off TA: Off PIN:

Date: 04 Sep 2015, Fri
 Time: 12:26

RT+

ODA Group: -

Title:

Album:

Track:

Artist:

Band:

Total groups received: 1171

% Count

	0	1	2	3	4	5	6	7	8	9	10	11	12	13	14	15	BER: 0.000
A:	86%		14%		0%												
B:																	

04 Sep 2015 Session time:
 12:26:34 59:55

All basic elements of the RDS/RBDS are displayed on the screen – *PI, PS, RT, TA/TP*, etc. Represented as a list, also available are the Alternative frequencies (*AF*). DB7007 supports one of the most used ODA Applications - Radio Text Plus. If your Radio station has *RT+*, DB7007 will display the information.

Total groups received

All received groups are systematized into a table, representing the percentage/quantity of the groups in the received RDS/RBDS signal. The user selects how the **Total groups received** data should be represented: as Percents [%] or as [Count], by selecting the corresponding button.

BER

Indicator with graphics is placed at the right bottom part of the screen, showing 60 sec. history of the BER quantities.

NOTE: The bit error rate or bit error ratio (BER) is the number of bit errors, divided by the total number of transferred bits during the observed time interval. Result closer or equal to 0 indicates that no bit errors are detected and vice versa - result closer or equal to 1 indicates that the received transferred bits are only errors.

BANDSCAN SCREEN

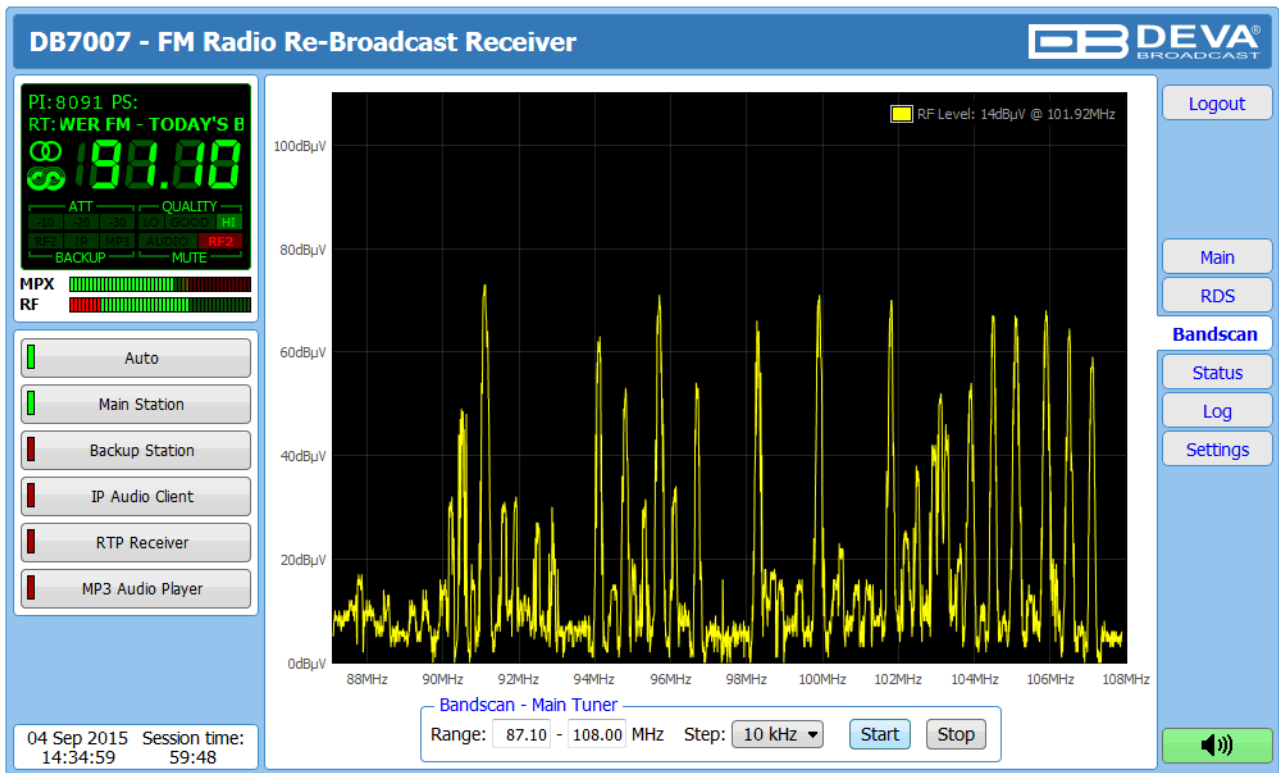

The **Bandscan** application utilizes four different types of band scan, depending on the preferred signal frequency step. The bandscanning mode could be customized by setting low and high frequency of the scan. Once you have set the frequency step and low/high frequency, the [Start] button should be pressed in order for the bandscan process to be initiated.

STATUS SCREEN

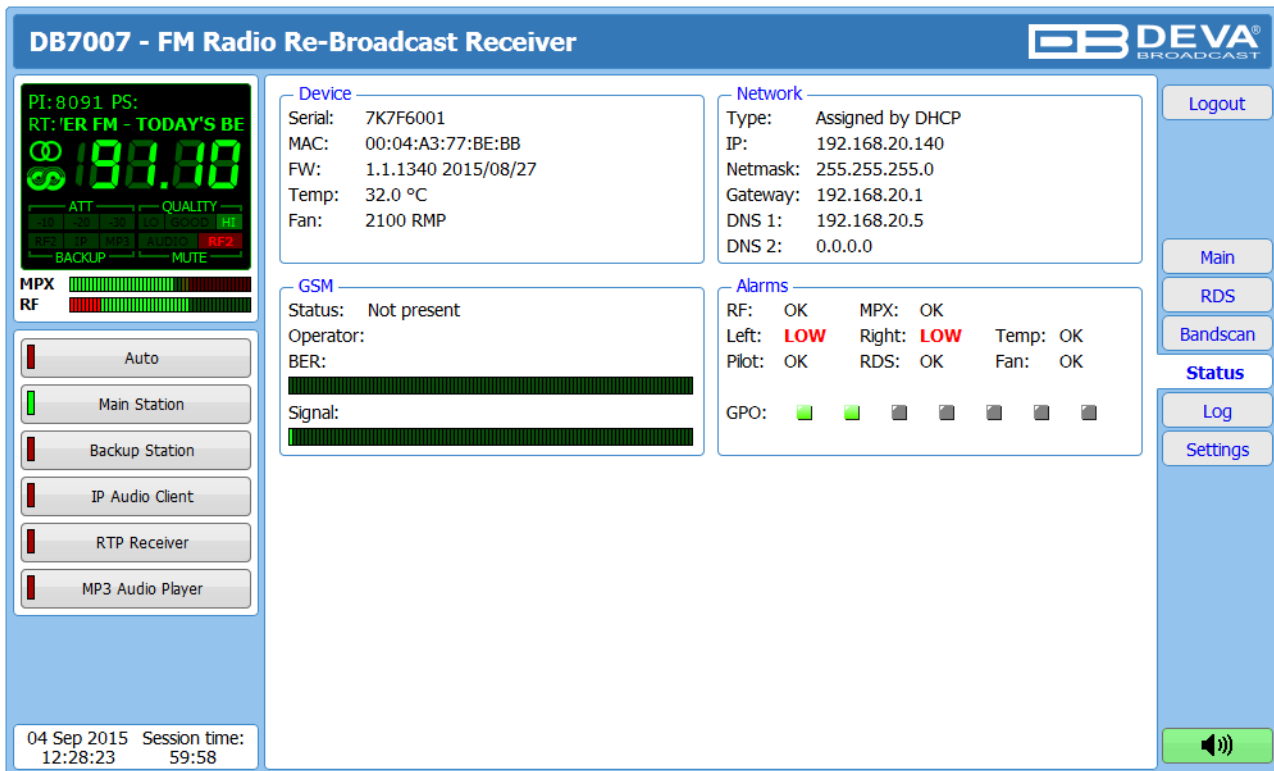

DB7007 - FM Radio Re-Broadcast Receiver

DEVA BROADCAST

Logout

PI: 8091 PS:
 RT: 'ER FM - TODAY'S BE
 188.80
 ATT QUALITY
 BACKUP MUTE RF2
 MPX
 RF

Device
 Serial: 7K7F6001
 MAC: 00:04:A3:77:BE:BB
 FW: 1.1.1340 2015/08/27
 Temp: 32.0 °C
 Fan: 2100 RMP

Network
 Type: Assigned by DHCP
 IP: 192.168.20.140
 Netmask: 255.255.255.0
 Gateway: 192.168.20.1
 DNS 1: 192.168.20.5
 DNS 2: 0.0.0.0

GSM
 Status: Not present
 Operator:
 BER:
 Signal:

Alarms
 RF: OK MPX: OK
 Left: **LOW** Right: **LOW** Temp: OK
 Pilot: OK RDS: OK Fan: OK
 GPO:

Auto
 Main Station
 Backup Station
 IP Audio Client
 RTP Receiver
 MP3 Audio Player

04 Sep 2015 Session time:
 12:28:23 59:58

Main
RDS
Bandscan
Status
Log
Settings

The status tab shows the alarm status of each parameter, along with the basic device and network status (IP address, MAC, etc.). If a GSM modem is connect to the DB7007, information on its current status will also be available.

The Alarm parameters (*RF*, *MPX*, *Pilot* etc.) have several conditions:

- In range - **OK**;
- Out of range - red **LOW** or **HIGH**;
- Signal monitoring is not enabled - **n/a**.

If a GPO is triggered, the relevant indicator will be lit.

NOTE: If you have connected a GSM modem to the DB7007 and there is still no information in the 'GSM' section, please check the cables and settings applied to the modem. If you continue to experience the same difficulties, please contact us at support@devabroadcast.com

LOG SCREEN

DB7007 - FM Radio Re-Broadcast Receiver

PI: 8091 PS:
 RT: R FM - TODAY'S BES
188.88
 ATT QUALITY
 BACKUP MUTE RF2
 MPX
 RF

Auto

Main Station

Backup Station

IP Audio Client

RTP Receiver

MP3 Audio Player

04 Sep 2015 Session time:
 12:28:40 59:41

2015-09-03 16:10:45	Control	Source Change, Backup Station, Auto selected
2015-09-03 16:42:06	Control	Backup Station RF Loss ACTIVE
2015-09-03 16:42:06	Control	Backup Station audio muted
2015-09-03 16:42:07	Control	Main Station RF Loss Inactive
2015-09-03 16:42:07	Control	Main Station audio unmuted
2015-09-03 16:42:07	Control	Source Change, MP3 Player, Auto selected
2015-09-03 16:42:08	Control	Source Change, Main Station, Auto selected
2015-09-03 16:42:22	Control	Main Station PI Protection ACTIVE
2015-09-03 16:42:22	Control	Main Station audio muted
2015-09-03 16:42:23	Control	Source Change, MP3 Player, Auto selected
2015-09-03 16:47:06	Alarm Idle	91.10MHz, RF OK [25.0 to 75.0]dBuV (70.0dBuV)
2015-09-03 17:27:52	Control	WEB Logout, 192.168.20.78
2015-09-04 12:24:38	Control	Source Change, Main Station, Auto selected
2015-09-04 12:24:38	System	Device is powered up
2015-09-04 12:24:39	Control	Backup Station RF Loss ACTIVE
2015-09-04 12:24:39	Control	Backup Station audio muted
2015-09-04 12:24:39	Control	Main Station RF Loss ACTIVE
2015-09-04 12:24:39	Control	Main Station audio muted
2015-09-04 12:24:40	System	Storage init OK
2015-09-04 12:24:40	Control	Source Change, MP3 Player, Auto selected
2015-09-04 12:24:43	Control	Main Station PI Protection ACTIVE
2015-09-04 12:24:51	Control	Main Station RF Loss Inactive
2015-09-04 12:25:40	Alarm	91.10MHz, Left < -27.0dB (-60.0dB)
2015-09-04 12:25:41	Alarm	91.10MHz, Right < -40.0dB (-60.0dB)
2015-09-04 12:25:43	Control	WEB Login, 192.168.20.40, Admin
2015-09-04 12:27:20	Control	Source Change, Main Station, Forced over WEB
2015-09-04 12:27:37	Control	Main Station PI Protection Inactive
2015-09-04 12:27:37	Control	Main Station audio unmuted

Logout

Main

RDS

Bandscan

Status

Log

Settings

🔊

Here are listed all the Device System Events, including the front panel activity WEB.

The local measurements and logs are saved in the internal device memory. All log files can be downloaded via the built-in FTP server using any kind of FTP client.

For information on how the connection between the DB7007 and an FTP Client should be configured, please [refer to "Download/Upload files via FTP" on page 91.](#)

GENERAL SETTINGS SCREEN

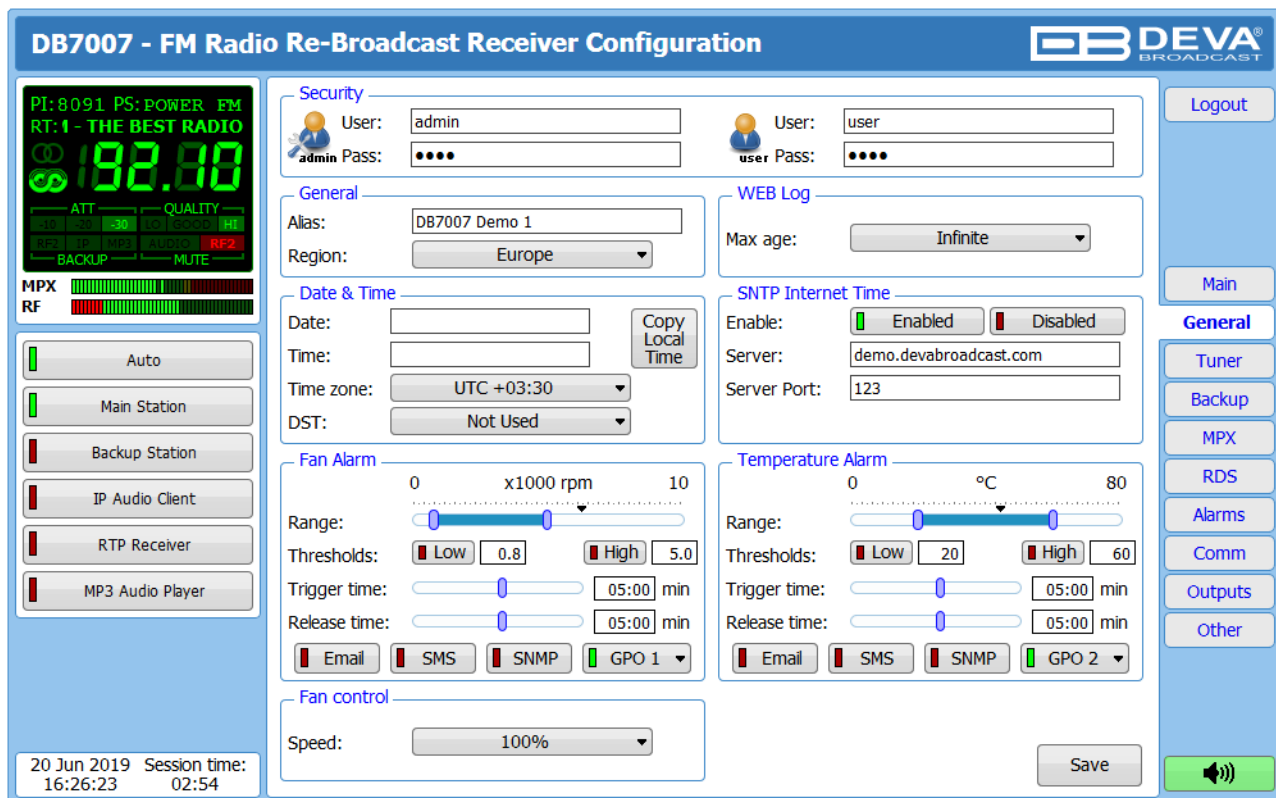

DB7007 provides you with protected access to the device settings. You can choose between two types of log in (**Security**):

- As an **Admin** – It will give you full control over the device's settings;
- As a **User** – that will allow you to just monitor the device and to choose different stations, while the Settings bar remains locked.

These credentials are also used to access the FTP server.

In order for the security of DB7007 to be enhanced, a new username and password could be set.

Alias – allow the name of the device to be changed. Later on, it will be used as a title name on all WEB pages. Customizing the name will make the device more recognizable.

Region – DB7007's tuning range is user selectable, 87.1-107.9 MHz (CCIR), 65-74 MHz (OIRT), 76-95 MHz (Japan). Changing/selecting the Region setting, will modify all tuner frequencies so that they could be within the FM band limits of the region chosen. This includes all Presets and Logger Channel frequencies.

WEB Log – the maximum storage time of the system log files is chosen from here. If the file is older than the specified maximum, the information will be deleted.

Date & Time – used to manually set the current **Date** and **Time**. [Copy Local Time] button will set the Date and Time to correspond to that of your computer.

SNTP Internet Time – Synchronizes automatically the DB7007 clock to a millisecond with the Internet time server. Enable this function in order to use it. (Specifying the server closest to your location will improve the accuracy).

Fan Alarm – Detects abnormal operation of the built-in fan. Define the parameters under which a fan alarm to be generated.

Temperature Alarm – Detects abnormal temperature of the equipment. Define the parameters under which a temperature alarm to be generated.

Fan Control – set the preferred speed of the built-in Fan.

NOTE: In order for the applied settings to be used press the [Save] button, placed on the bottom right part of the screen.

TUNER SETTINGS SCREEN

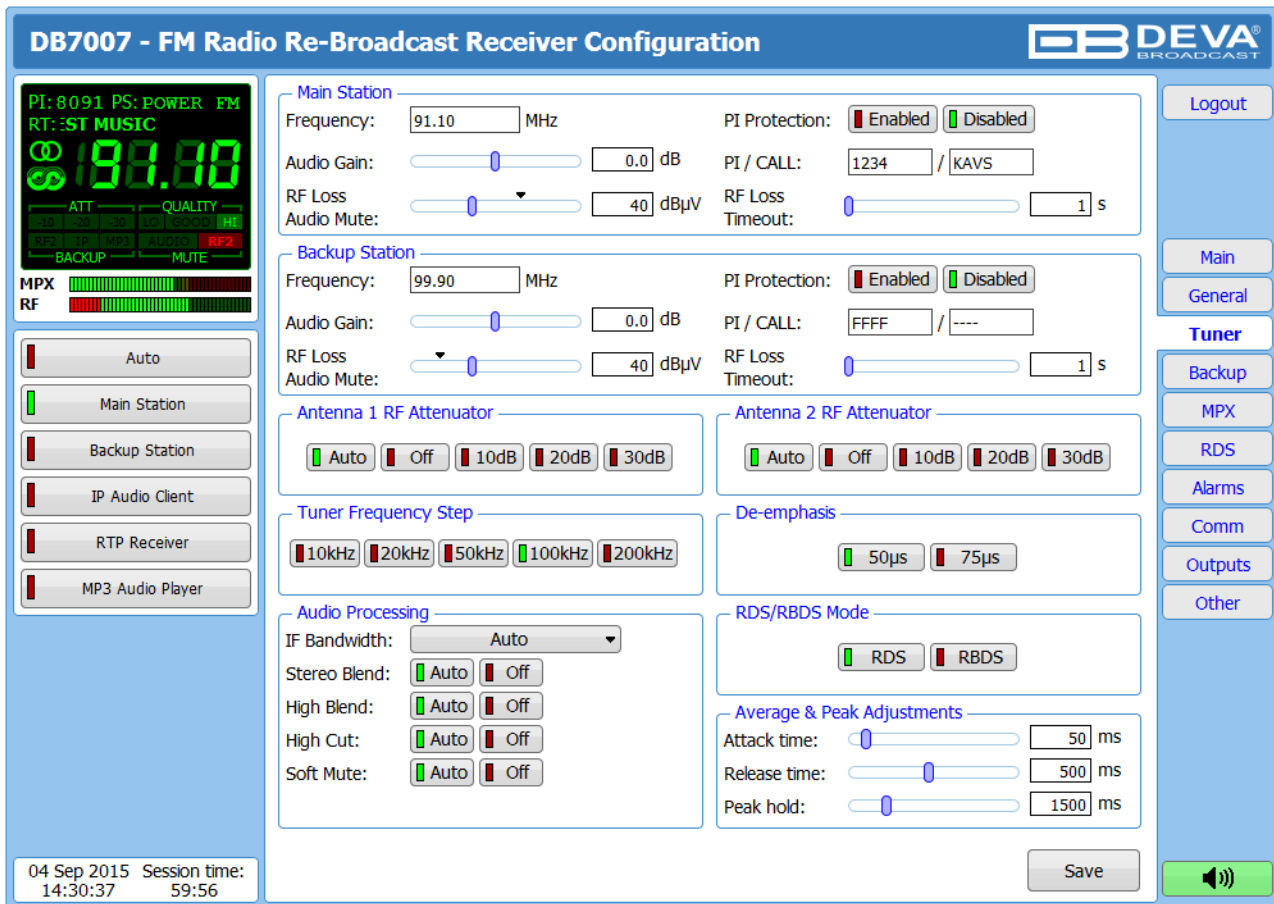

The Tuner Section gives full control over the tuner and **Audio Processing** settings. These settings provide all the needed adjustments to the algorithm which DB7007 processes the RF signal.

Main Station – here is specified the main frequency to be used, and PI protection parameters. The RF Loss Audio Mute and Timeout are also set in this section. Upon loss of Main Station’s RF, DB7007 will automatically switch to one of the backup sources. The priority of the sources is user-defined. For further information, please [refer to “Backup Settings Screen” on page 78](#).

Backup Station – similar settings as in the **Main Station** are applied in this section.

Average & Peak Adjustments section is used for setting of the indicators response times. Attack and Release times set the rate in which the indicators’ level will change in response to the signal. For most of the applications (including this one), the recommended attack time is shorter than the release time.

Peak-hold time – Permits retaining and displaying the peak value reached by the signal for a period of time predefined by the user.

RF Loss Protection Mode

The RF signal strength can vary by vast amounts. When the RF level is too low, the signal is distorted and buzzing. In order for this effect to be avoided, a value for the signal quality as per the RF level could be set, thus allowing the audio to be muted if the RF level is lower than the one set (for the specified timeout). Once the audio is muted, the built-in silence detector will observe this event. After the Audio Loss timeout expires, the DB7007 will switch to the back-up station, or the next by priority backup source.

The function is available for both the Main and Backup stations. The desired values are applied in the RF Loss Audio Mute and RF Loss Timeout.

When the mode is activated, the following warning message will appear:

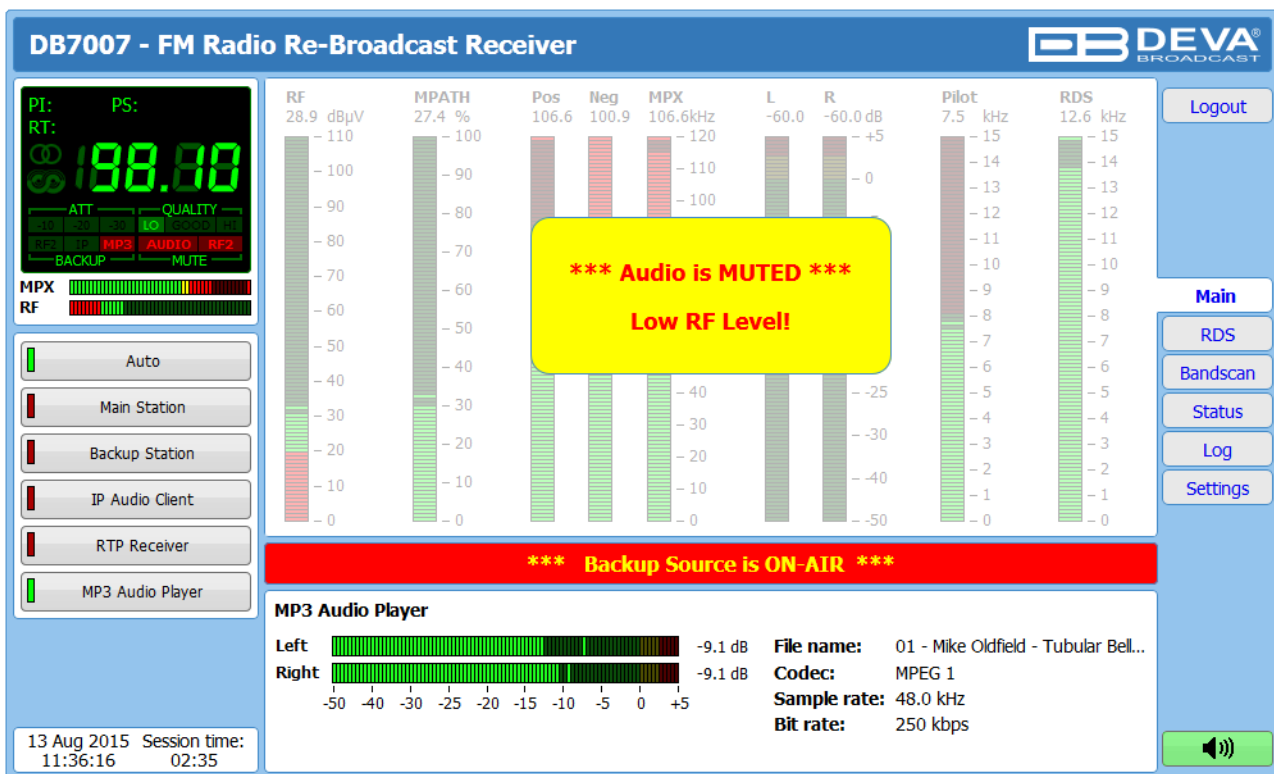

PI Protection Mode

If the unit detects another station on the same frequency, with different PI or without RDS/RBDS, the DB7007 will mute the audio and will switch to the back-up station, or the next by priority backup source.

The function is available for both, the Main and Backup stations. In order the function to be activated, you will have to enable the PI protection in the relevant sub-section and specify your station's PI/CALL so that it could be monitored.

When the mode is activated, the following warning message will appear:

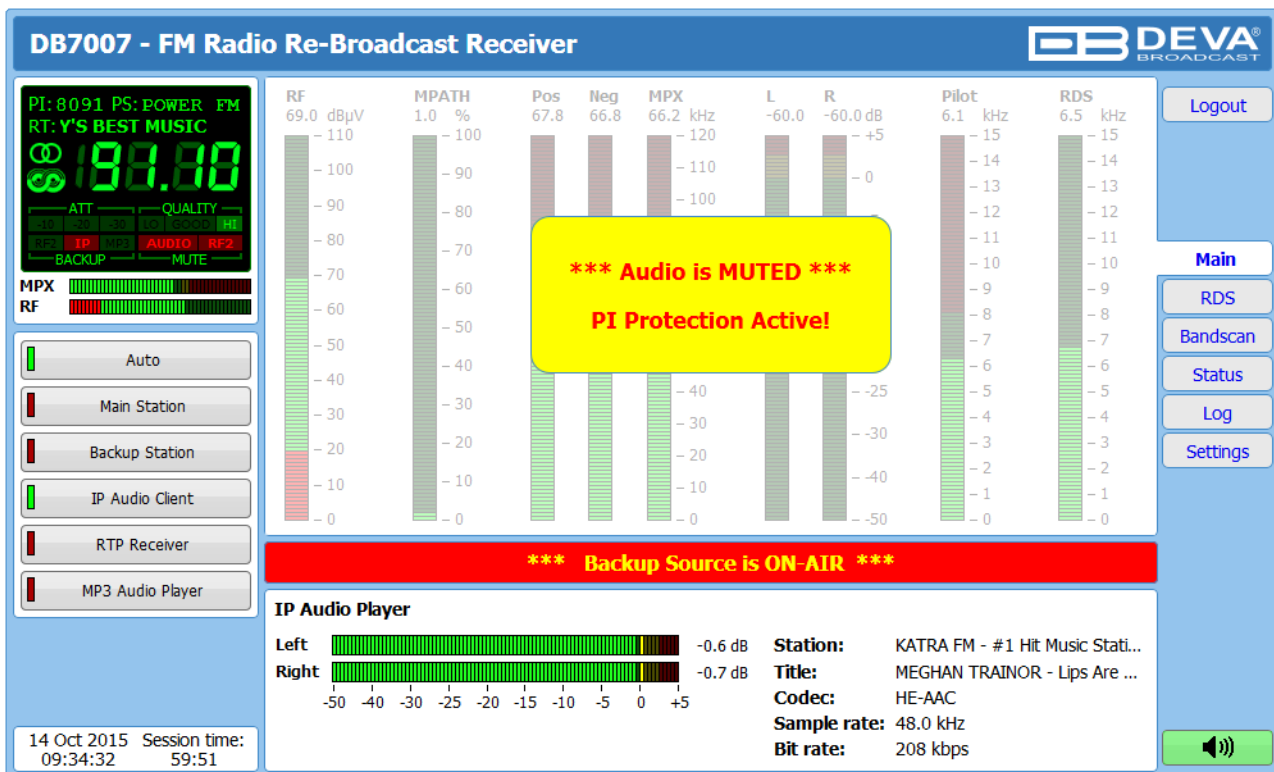

The screenshot displays the DB7007 - FM Radio Re-Broadcast Receiver interface. A central yellow box with red text reads: ***** Audio is MUTED ***** and **PI Protection Active!**. Below this, a red banner states: ***** Backup Source is ON-AIR *****. The interface includes various meters and controls:

- RF:** 69.0 dBµV
- MPATH:** 1.0 %
- Pos:** 67.8
- Neg:** 66.8
- MPX:** 66.2 kHz
- L:** -60.0
- R:** -60.0 dB
- Pilot:** 6.1 kHz
- RDS:** 6.5 kHz

On the left, there are buttons for **Auto**, **Main Station**, **Backup Station**, **IP Audio Client**, **RTP Receiver**, and **MP3 Audio Player**. The **IP Audio Player** section shows: **Left** at -0.6 dB and **Right** at -0.7 dB. The **Station:** is KATRA FM - #1 Hit Music Stati..., **Title:** MEGHAN TRAINOR - Lips Are ..., **Codec:** HE-AAC, **Sample rate:** 48.0 kHz, and **Bit rate:** 208 kbps. The bottom left corner shows the date **14 Oct 2015** and session time **09:34:32** / **59:51**. The right side has a **Logout** button and a navigation menu with **Main**, **RDS**, **Bandscan**, **Status**, **Log**, and **Settings**.

BACKUP SETTINGS SCREEN

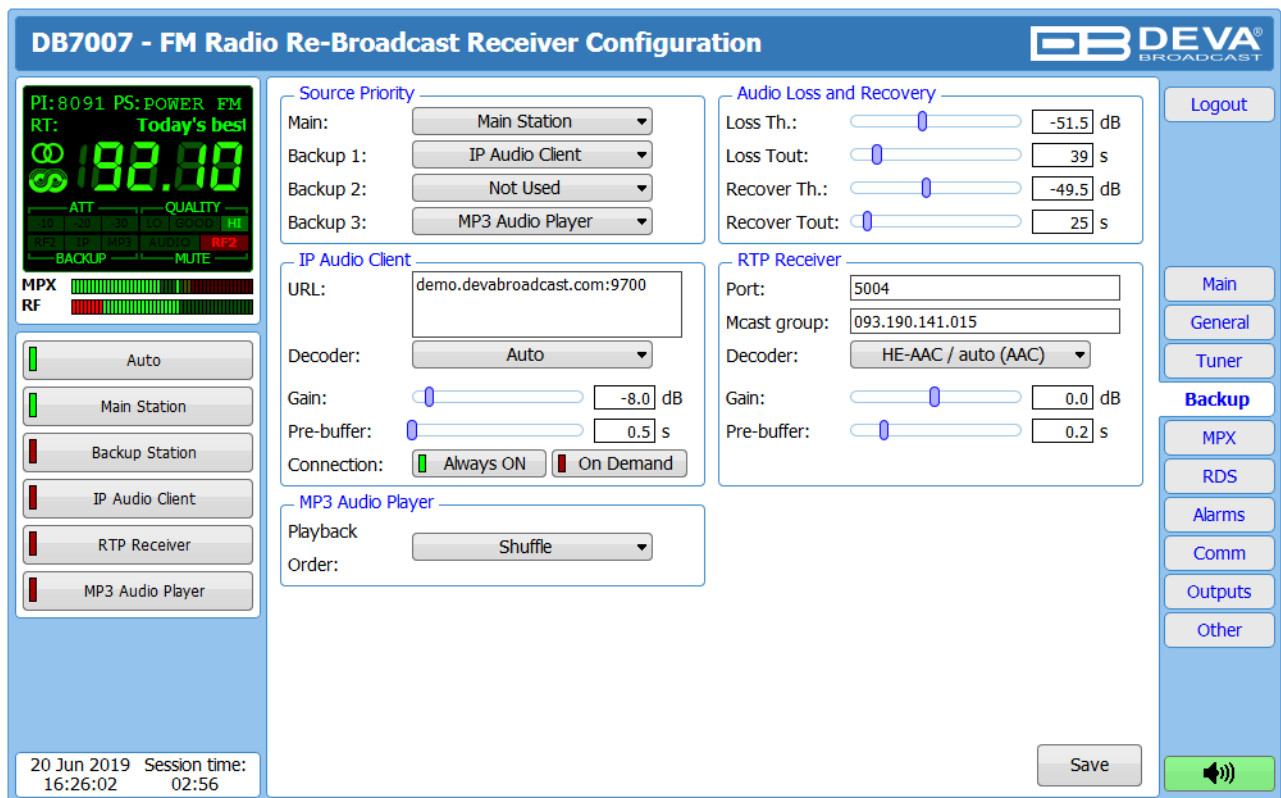

Through this screen are applied all needed settings to the alternative sources. The backup sources priority is user-defined and can be set through the relevant section. The main source is only one and cannot be changed. If the audio from the main source disappears, the DB7007 will automatically switch to the first backup source; if it also fails, the unit will switch to the second, etc. Once a source with higher priority is restored, the unit will switch back to it.

Audio Loss and Audio Recover – Select the appropriate levels of loss and recovery of the audio signal. Do not forget to set the corresponding timeouts.

IP Audio Client – Specify **URL**, **Decoder**, **Gain** and **Pre-buffer** time. Several options for decoder are available. The proper one can be chosen from the drop-down menu.

– **Connection** - Select connection type. **On Demand** will instruct IP Audio Client to establish a connection only when it is the current audio source, otherwise it will stay disconnected. This mode is useful for metered Internet connections. When set to **Always ON** the IP Audio Client will keep the connection active even when it is not the current source.

NOTE: On Demand does not apply if IP Audio Client is the Main backup priority. In this case it will work in **Always ON** mode.

NOTE: If Silence is detected while in **On Demand** mode, DB7007 will switch to the next backup priority and will disconnect the IP Audio Client connection. It will not return to IP Audio Client again before it switches to Main first.

RTP Receiver – Specify **Port**, **Decoder**, **Gain**, **Pre-buffer** adjustments and Multicast group IP.

FOR YOUR INFORMATION: A multicast address (**Mcast group**) is a logical identifier for a group of hosts in a computer network, that are available to process datagrams or frames intended to be multicasted for a designated network service.

MP3 files upload via FTP

DB7007 has a built-in backup audio file player. It plays tracks from SD Card storage which are uploaded over the FTP. All backup audio files must be located in the folder named Audio (that could be found in the root of the SD card). Subfolders are not allowed. The playlist file, if used, must be named playlist.m3u.

For information on how the connection between the DB7007 and an FTP Client should be configured, please refer to “Download/Upload files via FTP” on page 91.

MPX SETTINGS SCREEN

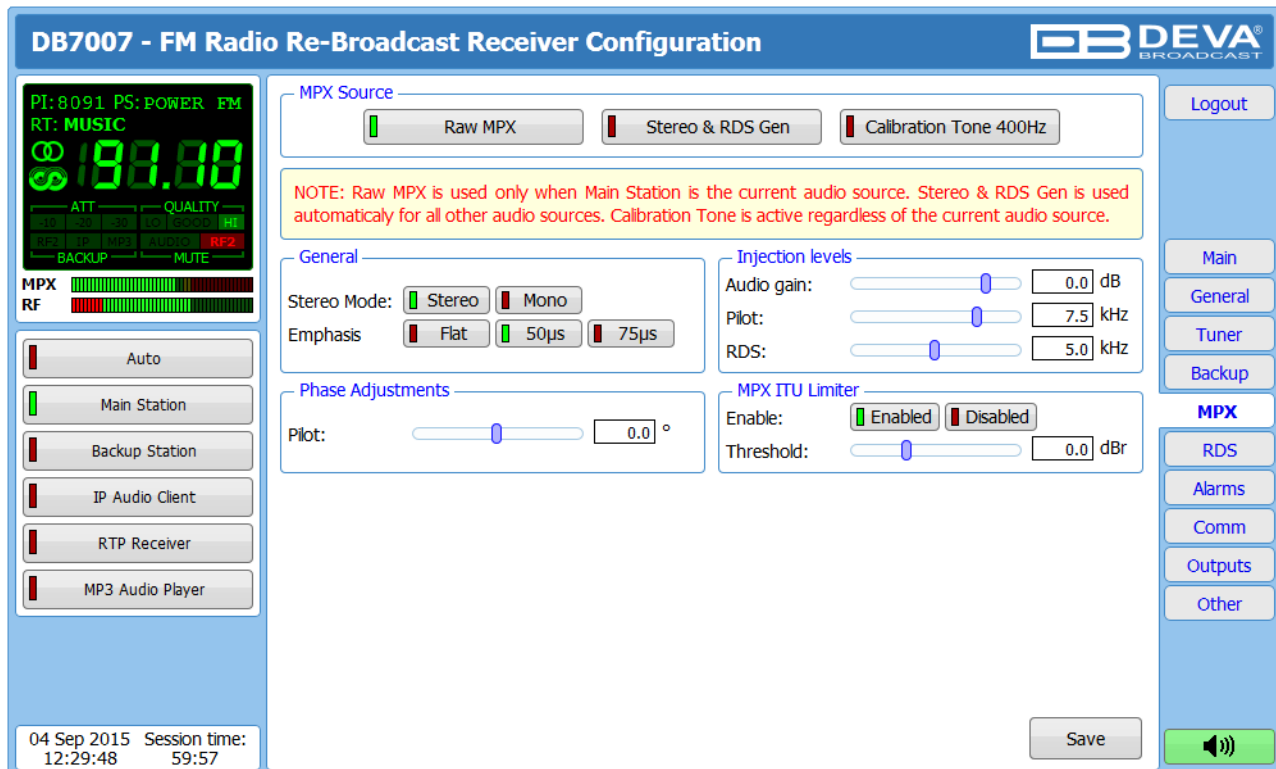

The screenshot displays the 'DB7007 - FM Radio Re-Broadcast Receiver Configuration' interface. The top left shows a digital display with 'PI: 8091 PS: POWER FM RT: MUSIC' and a frequency of '198.00'. Below the display are 'MPX' and 'RF' level meters. The main configuration area is divided into several sections:

- MPX Source:** Three radio buttons for 'Raw MPX', 'Stereo & RDS Gen', and 'Calibration Tone 400Hz'. A note states: 'NOTE: Raw MPX is used only when Main Station is the current audio source. Stereo & RDS Gen is used automatically for all other audio sources. Calibration Tone is active regardless of the current audio source.'
- General:** 'Stereo Mode' with 'Stereo' and 'Mono' options; 'Emphasis' with 'Flat', '50µs', and '75µs' options.
- Injection levels:** Sliders and input boxes for 'Audio gain' (0.0 dB), 'Pilot' (7.5 kHz), and 'RDS' (5.0 kHz).
- Phase Adjustments:** A slider and input box for 'Pilot' (0.0°).
- MPX ITU Limiter:** 'Enable' with 'Enabled' and 'Disabled' options; 'Threshold' slider and input box (0.0 dB).

 A sidebar on the right contains buttons for 'Logout', 'Main', 'General', 'Tuner', 'Backup', 'MPX', 'RDS', 'Alarms', 'Comm', 'Outputs', and 'Other'. A 'Save' button is located at the bottom right. The bottom left corner shows the date '04 Sep 2015' and session time '12:29:48'.

MPX Source – Set the preferred MPX Source. The following options are available:

- [Raw MPX] – demodulated MPX received from the Main Station station;
- [Stereo & RDS Gen] – MPX generated from the built-in Stereo and RDS Generator;
- [Calibration Tone 400Hz] – single tone of 400Hz, used for calibrating of the inputs of the devices connected to the MPX output.

NOTE: Raw MPX is used only when Main Station is the current audio source. Stereo & RDS Gen is used automatically for all other audio sources. Calibration Tone is active regardless of the current audio source.

General Settings – The settings of the stereo generator are applied through this section. [Stereo] or [Mono] processing and user-defined **Emphasis** could be set.

Injection levels – Set the levels of the components included in the obtained final stereo multiplex signal.

Phase Adjustments – The phase of the **Pilot** is set through this section.

MPX ITU Limiter– The regulatory authorities, in some countries, require the total MPX Power not to exceed 0dB_r. Therefore, DB7007 has a built-in MPX ITU limiter that restrains the deviation below the predefined threshold. The default **Threshold** is 0dB_r.

RDS/RBDS SETTINGS SCREEN

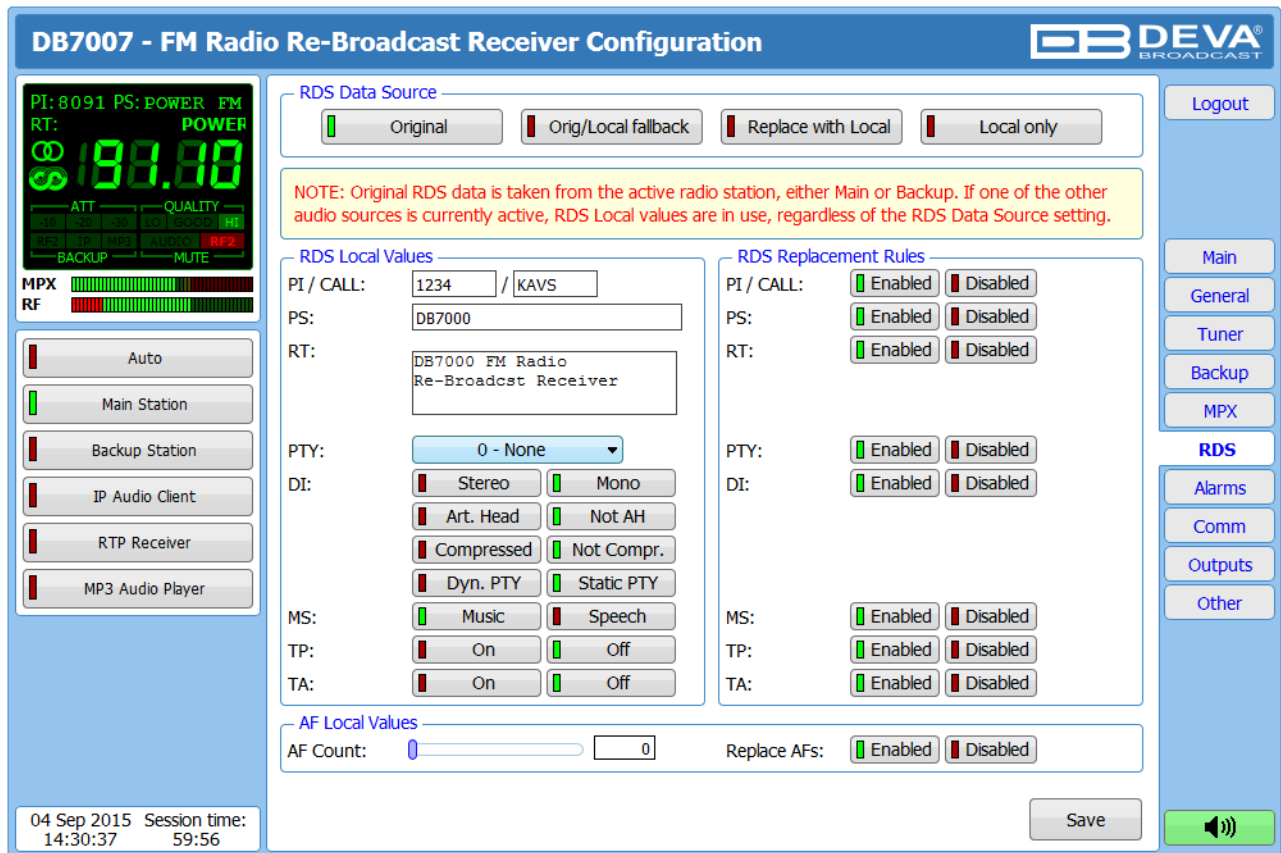

DB7007 - FM Radio Re-Broadcast Receiver Configuration

RDS Data Source

Original
 Orig/Local fallback
 Replace with Local
 Local only

NOTE: Original RDS data is taken from the active radio station, either Main or Backup. If one of the other audio sources is currently active, RDS Local values are in use, regardless of the RDS Data Source setting.

RDS Local Values

PI / CALL: 1234 / KAVS
 PS: DB7000
 RT: DB7000 FM Radio Re-Broadcast Receiver
 PTY: 0 - None
 DI: Stereo Mono
 Art. Head Not AH
 Compressed Not Compr.
 Dyn. PTY Static PTY
 MS: Music Speech
 TP: On Off
 TA: On Off

RDS Replacement Rules

PI / CALL: Enabled Disabled
 PS: Enabled Disabled
 RT: Enabled Disabled
 PTY: Enabled Disabled
 DI: Enabled Disabled
 MS: Enabled Disabled
 TP: Enabled Disabled
 TA: Enabled Disabled

AF Local Values

AF Count: Replace AFs: Enabled Disabled

04 Sep 2015 Session time: 14:30:37 59:56

RDS Data Source:

- [Original] – Original RDS/RBDS data received from the station;
- [Original/Local fallback] – Upon loss of the original RDS/RBDS the local data will be used;
- [Replace with local] – User-defined combination of the original and local RDS/RBDS data;
- [Local only] – User-defined local RDS/RBDS data only.

When [Replace with local] RDS data source is chosen, the RDS/RBDS parameters could be replaced with the specified in **RDS Local Values** section. Whether a parameter would be changed to its local value on the fly, is specified in section **RDS Replacement Rules**.

NOTE: Original RDS data is taken from the active radio station, either Main or Backup. If one of the other audio sources is currently active, RDS Local values are in use, regardless of the RDS Data Source setting.

RDS Local Values – RDS/RBDS Local Values are defined through this section.

AF Local Values – Set the total needed number of alternative frequencies and their value. The option Replace AFs is also available.

ALARMS SETTINGS SCREEN

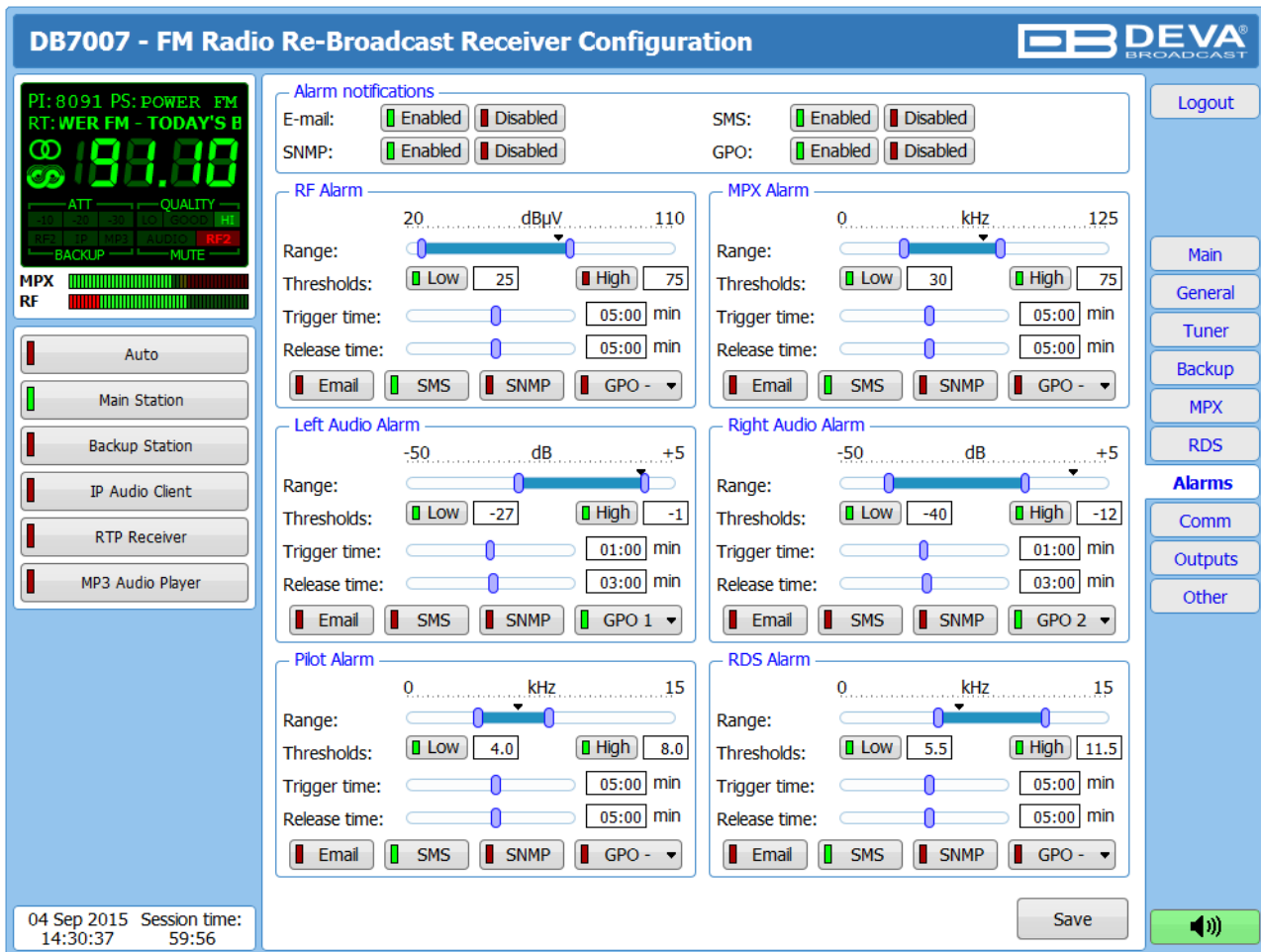

DB7007 - FM Radio Re-Broadcast Receiver Configuration

Alarm notifications

E-mail: Enabled Disabled SMS: Enabled Disabled
 SNMP: Enabled Disabled GPO: Enabled Disabled

RF Alarm (Range: 20 dBµV to 110)

Range: [Slider] Thresholds: Low 25 High 75
 Trigger time: [Slider] 05:00 min Release time: [Slider] 05:00 min
 Email SMS SNMP GPO -

MPX Alarm (Range: 0 kHz to 125)

Range: [Slider] Thresholds: Low 30 High 75
 Trigger time: [Slider] 05:00 min Release time: [Slider] 05:00 min
 Email SMS SNMP GPO -

Left Audio Alarm (Range: -50 dB to +5)

Range: [Slider] Thresholds: Low -27 High -1
 Trigger time: [Slider] 01:00 min Release time: [Slider] 03:00 min
 Email SMS SNMP GPO 1

Right Audio Alarm (Range: -50 dB to +5)

Range: [Slider] Thresholds: Low -40 High -12
 Trigger time: [Slider] 01:00 min Release time: [Slider] 03:00 min
 Email SMS SNMP GPO 2

Pilot Alarm (Range: 0 kHz to 15)

Range: [Slider] Thresholds: Low 4.0 High 8.0
 Trigger time: [Slider] 05:00 min Release time: [Slider] 05:00 min
 Email SMS SNMP GPO -

RDS Alarm (Range: 0 kHz to 15)

Range: [Slider] Thresholds: Low 5.5 High 11.5
 Trigger time: [Slider] 05:00 min Release time: [Slider] 05:00 min
 Email SMS SNMP GPO -

04 Sep 2015 Session time: 14:30:37 59:56 **Save**

Alarm notifications

E-mail – global enable/disable E-mail notification;

SMS – global enable/disable SMS notification;

SNMP – global enable/disable SNMP notification;

GPO – global enable/disable GPO actions.

The settings applied to each of the available alarms (**RF**, **MPX**, **Left Audio**, **Right Audio**, **Pilot** and **RDS**) are identical and are explained in details below:

Range – interactive slider used to adjust the Low & High thresholds at which an alarm will be generated;

Trigger Time – waiting time before Active Alarm is generated;

Release Time – waiting time before Idle Alarm is generated;

NOTE: For detailed information on Alarm trigger and notifications refer to “[APPENDIX 1: Alarm Triggers](#)” on page 87.

COMMUNICATION SETTINGS SCREEN

DB7007 - FM Radio Re-Broadcast Receiver Configuration

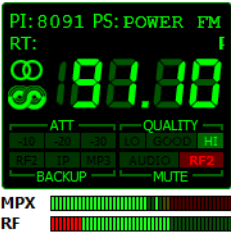

Auto

Main Station

Backup Station

IP Audio Client

RTP Receiver

MP3 Audio Player

Network

Enable: Enabled Disabled

DHCP: Enabled Disabled

IP Address:

Netmask:

Gateway:

Primary DNS:

Sec. DNS:

GSM Modem

Number 1:

Number 2:

Number 3:

Number 4:

Number 5:

Baudrate:

Modem Type:

HTTP Server

Enable: Enabled Disabled

Server Port:

Session time: min

Application Server

Enable: Enabled Disabled

Server Port:

Session time: min

FTP Server

Enable: Enabled Disabled

Cmd Port:

Data Port:

Audio Stream Server

Enable: Enabled Disabled

Server Port:

Quality:

SNMP Agent

Agent: Enabled Disabled

Agent Port:

Agent ses. time: min

Agent ID:

Read Community:

Write Community:

Manager IP:

Manager Port:

SNMP MIB File:

E-mail

Enable: Enabled Disabled

E-mail 1:

E-mail 2:

Sender:

Username:

Password:

Host name:

Connection:

Server:

Server Port:

UECP UDP Relay

Enable: Enabled Disabled

Server:

Server Port:

Syslog

Enable: Enabled Disabled

Server:

Server Port:

UECP TCP Server

Enable: Enabled Disabled

Server Port:

USB Port

Enable: Enabled Disabled

04 Sep 2015 Session time:
14:31:21 59:58

▲ - These settings require reboot.

Comm

WARNING: The applied changes will take effect upon pressing the [Save] button. All settings marked with the symbol ▲ require reboot, therefore the [Save & Reboot] button should be used.

NOTE: If the new value is invalid or out of range, the edited field will become red.

Network

The network addresses could be set manually (static IP) or automatically via a DHCP server. To set static *IP Address*, *Netmask*, *Gateway* and *DNS* addresses, the *DHCP* should be disabled. In order for the built-in DHCP client to be activated, the function should be enabled. When the DHCP client is activated, all assigned values will be shown in the relevant fields on the Status screen. If due to any reason, the DHCP procedure cannot be completed, DB7007 will use AutoIP and will generate an IP Address.

- 82 -

HTTP Server

Specify the *HTTP Server Port* and *Session time*. The WEB Interface session timeout is set through *Session Time* slider.

FTP Server

[Enabled]/[Disabled] the *FTP Server*. Specify the *Comm Port* and *Data Port* to be used.

SNMP Agent

Specify *Agent ID*, *Agent Port*, *Read/Write Communities*, *Manager IP*, *Manager Port* and *Agent ses. time* (Agent session timeout).

Agent - [Enabled]/[Disabled] SNMP Agent.

Agent ID is used for identification of the device among others, when an SNMP notification is being sent.

Once all needed settings are applied, use the [Test] button to generate a test notification, which upon success will be received by the SNMP Manager.

Press the [Download] button to download the DB7007's SNMP MIB file. The MIB file may vary from one firmware revision to another. Downloading this file from the device, guarantees that you have the proper MIB file.

Syslog

[Enabled] or [Disabled] the syslog feature. Specify *Server address* and *Server Port* to be used.

GSM Modem

Up to five numbers for SMS control and alarm notifications could be set. *Baudrate* is mandatory for the proper operation of the GSM Modem.

We recommend that a test SMS to be generated (via pressing the [Test] button), once all needed settings are applied. Upon success, the SMS will be delivered to all the specified GSM numbers.

Example of Test SMS Message:

DB7007 Test Message .

NOTE: The current condition of the GSM Modem could be checked in the [“Status Screen”](#).

Audio Stream Server

Specify *Server Port* for audio streaming, and Quality (**64, 96, 128, 192** or **256 kbps**). The audio stream could be heard using suitable audio player (Media Player, Winamp, etc.) or through the WEB interface by pressing the [Listen] button.

E-mail

Enter the desired alarm recipients in *E-mail 1* and/or *E-mail 2* fields. Fill in your e-mail account settings: *Sender*, *Username* and *Password*, *Server*, *SNMP port* and *Connection* type.

We recommend you to use the [Test] button and generate a test e-mail, which upon success will be delivered to the specified E-mail 1 and/or E-mail 2.

Example of Test E-mail Message:

```
DB7007 Test Message.  
Please do not reply to this e-mail.
```

UECP UDP Relay & UECP TCP Server

The unit can relay the received RDS as a UECP stream. There are two possible options:

Option 1 – via UDP, where the device sends the received RDS as UECP encoded UDP packets unconditionally to the specified IP Address and Port. The receiver could be an RDS/RBDS Encoder SmartGen, other RDS Encoder, or Monitoring Software.

Option 2 – via TCP. The unit has built in server and a Monitoring Software to receive the UECP encoded RDS data could be connected to the unit.

USB Port

[Enabled]/[Disabled] USB port.

OUTPUTS SETTINGS SCREEN

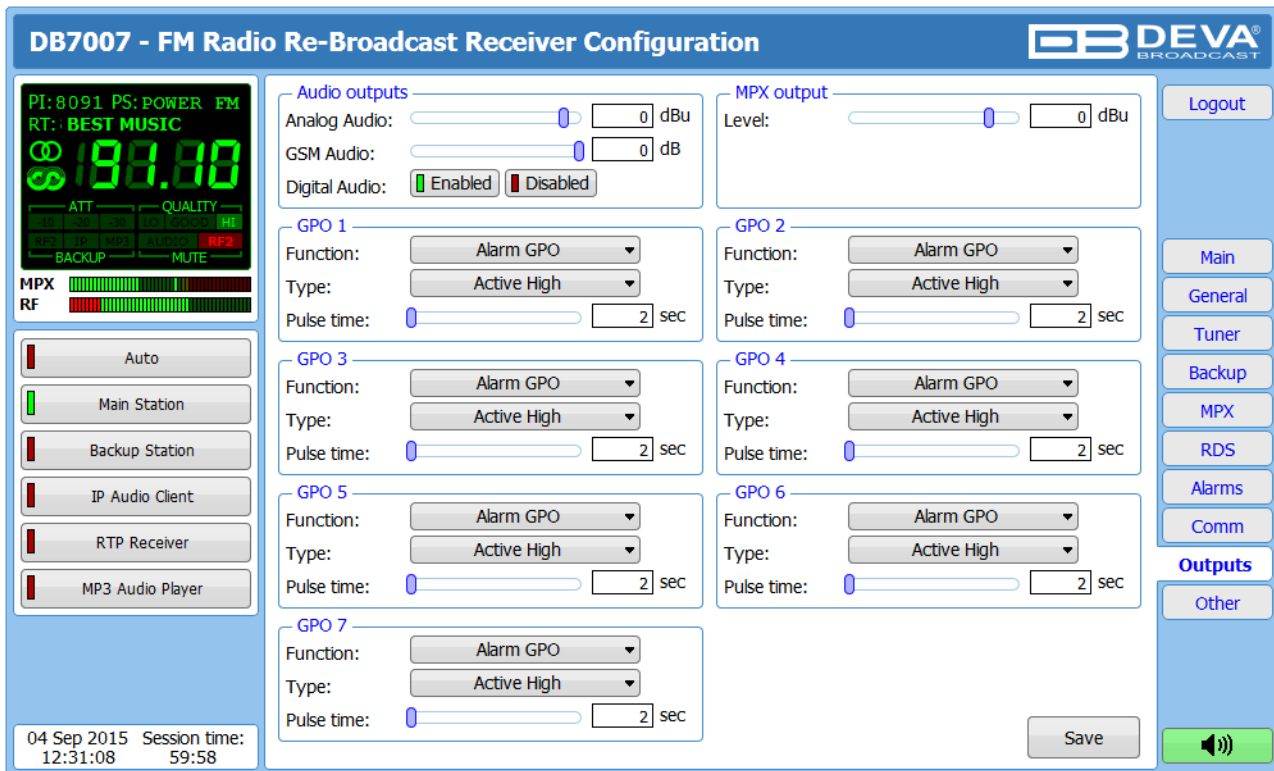

The screenshot displays the 'DB7007 - FM Radio Re-Broadcast Receiver Configuration' web interface. The top header includes the DEVA BROADCAST logo and the title. The main content area is divided into several sections:

- Audio outputs:** Includes sliders for Analog Audio (0 dBu), GSM Audio (0 dB), and a Digital Audio toggle (Enabled/Disabled).
- MPX output:** Includes a Level slider (0 dBu).
- General Purpose Outputs (GPO 1-7):** Each GPO has a 'Function' dropdown (set to 'Alarm GPO'), a 'Type' dropdown (set to 'Active High'), and a 'Pulse time' slider (set to 2 sec).
- Left Panel:** A status display showing 'PI: 8091 PS: POWER FM RT: BEST MUSIC' and '188.80'. Below it are indicators for MPX and RF, and a list of services: Auto, Main Station, Backup Station, IP Audio Client, RTP Receiver, and MP3 Audio Player.
- Right Panel:** A navigation menu with buttons for Logout, Main, General, Tuner, Backup, MPX, RDS, Alarms, Comm, **Outputs** (highlighted), and Other.
- Bottom:** A 'Save' button and a speaker icon.
- Footer:** Date and session time: '04 Sep 2015 Session time: 12:31:08 59:58'.

The general purpose outputs settings are applied through this page. The *Audio output* and *MPX output* sections allow setting the audio and MPX outputs, according to your needs.

Function, *Type* and *Pulse time* for each of the GPOs could be set individually. You can choose between the following functions: **Alarm GPO**, **RDS Lock**, **TA Flag** and **TP Flag**. Type is used for specifying of the active level. When an alarm is generated, the output can change the level to **Active High/Low** or to generate **High/Low Pulse**.

NOTE: If the GPO's function is not assigned as **Alarm GPO** and the selfsame is chosen as a preferred alarm, notifications will not be indicated, nevertheless one is being generated.

OTHER SETTINGS SCREEN

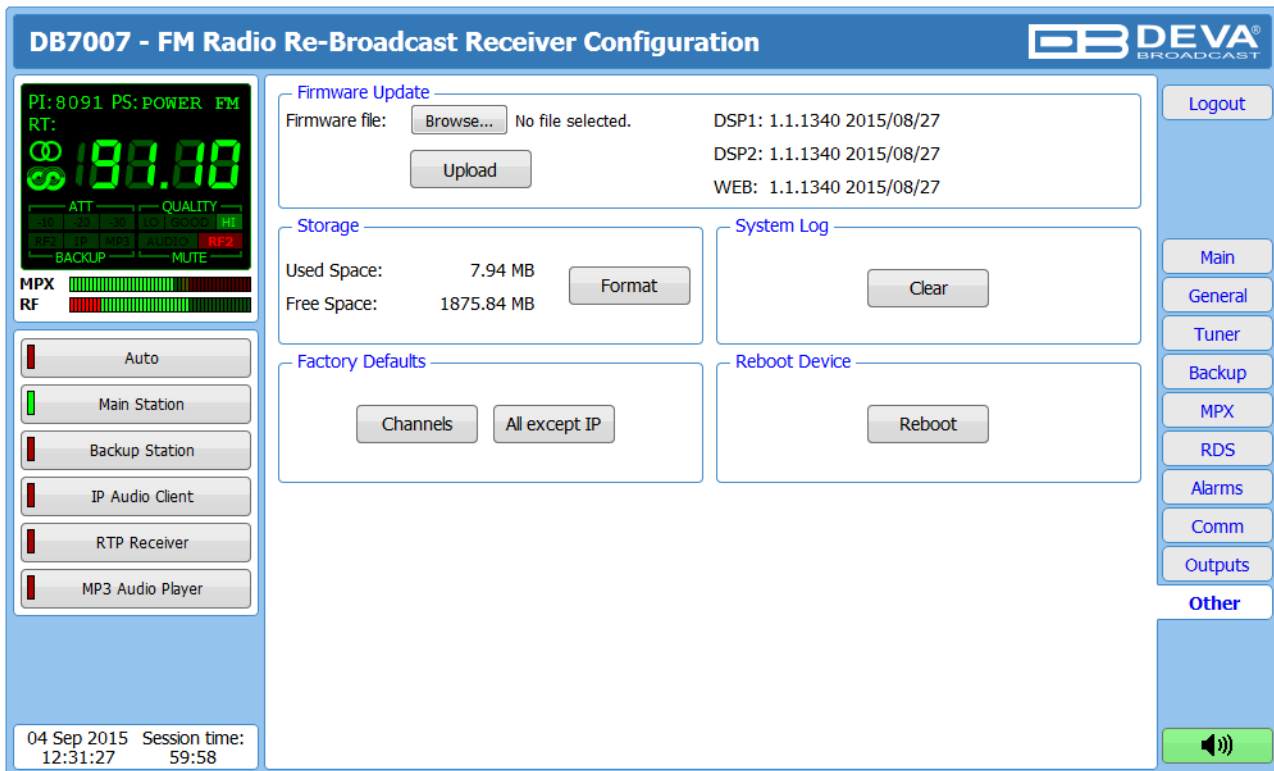

Firmware Update

To update the device firmware, select the new firmware file. After having pressed the [Upload] button, a dialog window will appear. Confirm the firmware update and wait for the process to complete. Information on *DSP1*, *DSP2* and *WEB* is also found in this section.

Storage

Information about the device storage space is found in this section. The internal storage could be deleted by pressing the [Format] button.

System Log

By pressing the [Clear] button, all recorded in the system log information will be deleted.

Factory Defaults

Pressing the [All except IP] button will delete all settings except for the Network settings (IP Address).

To restore DB7007 to its Factory Defaults you should press [All except IP]. A new window will appear - confirm that you want to restore the factory defaults and wait for the process to be completed. On completion of the process, the settings should have the proper default values.

Reboot

To start Rebooting of DB7007, press the [Reboot] button. A dialog warning window will appear. Confirm that you want to reboot the device and wait for the process to be completed.

APPENDIX 1

ALARM TRIGGERS

After collecting all the data, the DSP-based core compares the values measured with the predefined by the user threshold levels, for all the alarms monitored. In case that a parameter is beyond limits, the device will initiate the sending of an alarm notification via the selected communication path. All the alarm events are stored in the device's log. It is essential that, if there is a very short fault of the signal, with duration shorter than the alarm Trigger time, the device would not trigger an alarm.

There are several Alarm Triggers for the following parameters: **RF**, **MPX**, **Left/ Right Audio**, **Pilot** and **RDS levels**. An option for defining different limits for each of the parameters is present. All these values, the **Trigger time** and the **Release time** have to be assigned separately for each of the alarms.

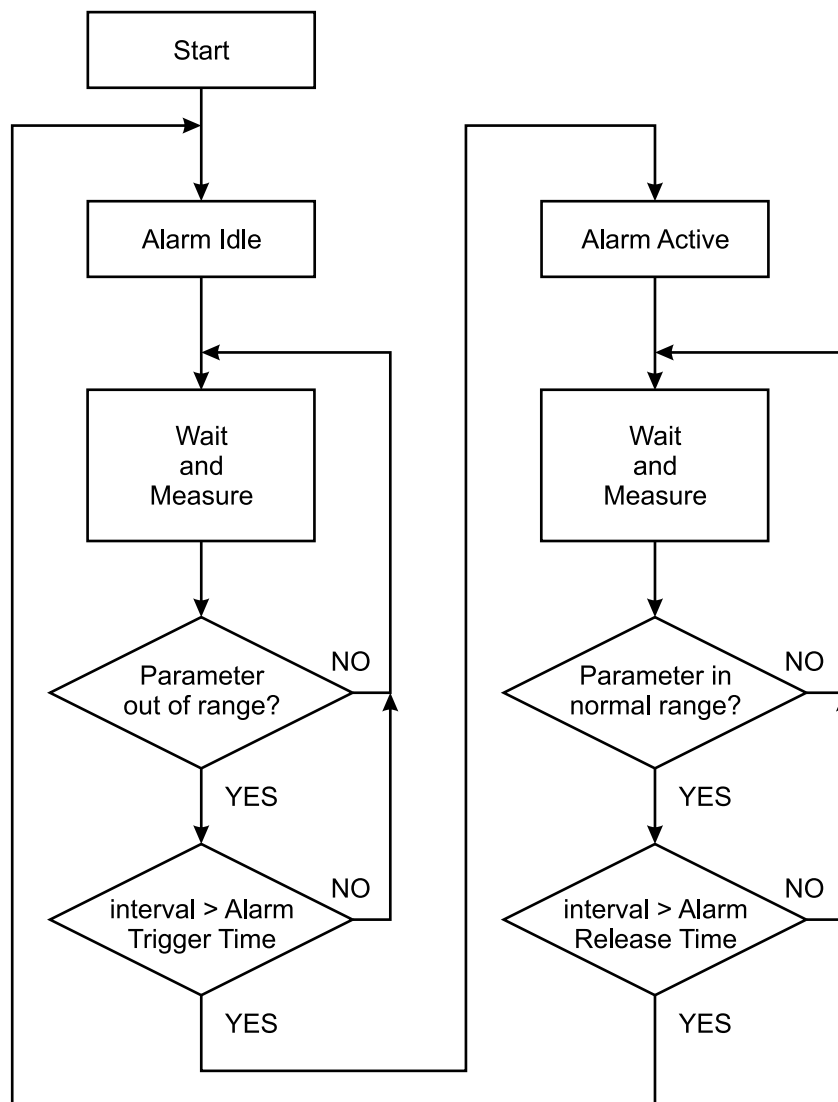

Block Diagram of Alarm Automata

When an observation event takes place, the alarm trigger's state will refresh, if necessary. Should we consider an instance when the alarm trigger is in **Idle** state, having in mind that an alarm is not triggered immediately when a parameter level passes beyond threshold: If the parameter level becomes stable, within thresholds, and the alarm **Trigger time** is not elapsed, then the alarm trigger remains in **Idle** state. If the alarm **Trigger time** expires and the parameter level is still beyond limits, the **Alarm trigger** would change its state to **High/Low**. This would result in predefined actions - alarm notifications (E-mail, SMS, SNMP trap) and save a log record. The state will not be immediately switched into **Idle** when the parameter stabilizes, within threshold levels, not up until the alarm **Release time** is elapsed. Meanwhile, if the parameter crosses again any threshold, the **Alarm trigger** will remain in active state. If the parameter remain within the threshold levels and the alarm **Release time** expires, then the **Alarm trigger** would switch into **Idle** state and again predefined actions would be initiated.

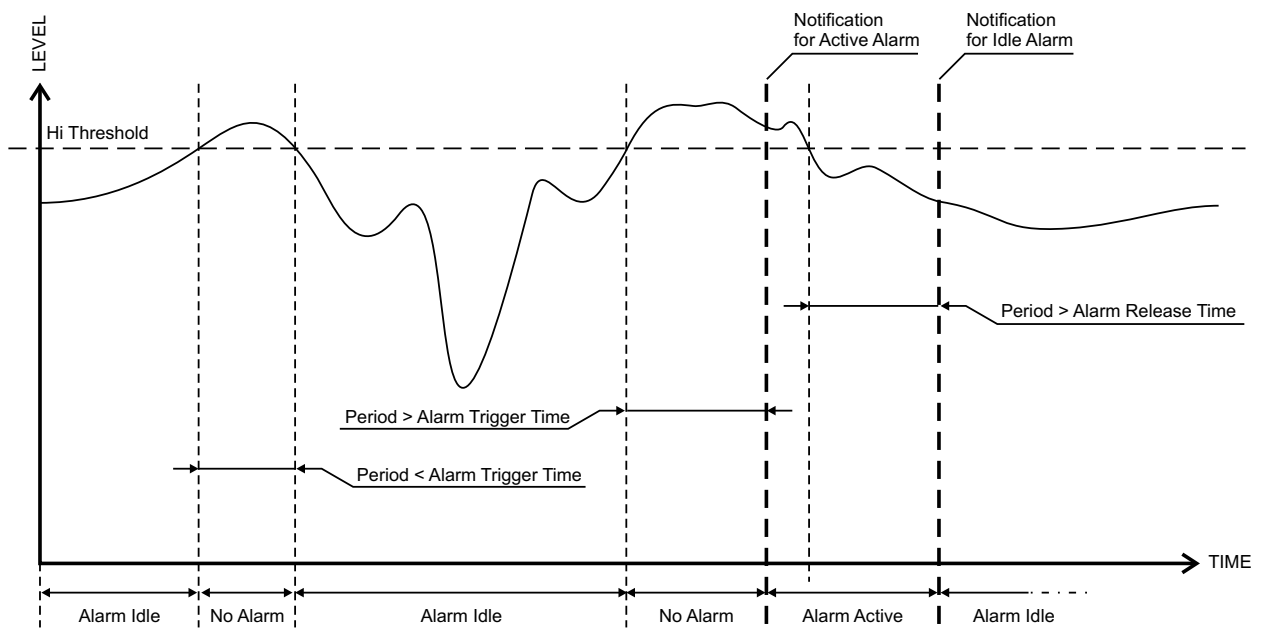

ALARM NOTIFICATION

The E-mail, SMS, SNMP trap Alarm Notifications contain the following information - device's Alias, date and time of Alarm triggered, frequency and information about the Alarm activation/deactivation. The basic signal parameters are also included.

Example for E-mal Notification:

```
Date: 04 Nov 2012, 07:31:11
DB7007 reports ACTIVE alarm on 99.90MHz
Alarm: RDS > 6.5kHz
Signal parameters:
RF: 51.5dBuV
MPX Total: 89.9kHz
Pilot: 7.5kHz
RDS: 11.4kHz
Left: -7.2dB
Right: -8.2dB
```

Example for SMS Notification:

```
ACTIVE ALARM
27.09.2013 09:08:34
FREQ:95.7MHz
RF:35.0dBuV *L*
MPX:60.3kHz
Left:-2.8dB
Right:-3.1dB
Pilot:7.92kHz
RDS:4.12kHz
```

NOTE: L means LOW (below threshold), H for HIGH (above threshold).

ATTENTION: Because of the SMS length limitations, only the most important parameters are included.

APPENDIX A

RDS: EUROPE VS AMERICA

The European Broadcasting Union (EBU) and its member countries originated the concept of “Radio Data” transmission. The European RDS specification, CENELEC Standard EN50067, was first published in 1984. It was revised in 1986, 1990, 1991 and 1992.

European RDS has grown in use following initial adoption of the Standard. RDS is nearly universal throughout Europe; it is almost impossible to find a European FM broadcasting station that does not carry a radio data subcarrier.

The popularity of RDS in Europe is very much in contrast with initial reluctance on the part of US broadcasters to embrace this technology. This can be ascribed to material differences in broadcasting practices.

Almost without exception, FM broadcasting in the United States is ‘detached’ and independent - each station originates its own programming. America’s National Public Radio might be considered as an exception, though for most of the broadcast day even NPR stations originate, or at least schedule, their own programs.

Most of European broadcasting is similar to the concept of network radio that was common in the US prior to the 1950s. In Europe, a central program originator may have many transmitting facilities of modest power situated throughout the country, at several different frequencies to blanket a designated service area. The European disposition, toward lower-power transmitters can be found on the “local radio” level, as well.

The European concept of a service area equates to the US broadcaster’s market. The subtle difference between these designations further characterizes broadcasting practices and ethics. RDS benefits the European broadcaster through almost an altruistic endeavor to be of service to his listeners. The US broadcaster is marketing his programming and is primarily interested in how he can create additional revenue from RDS.

THE RDS SYSTEM

RDS is a digital data channel, transmitted as a low-level subcarrier above the range of the composite stereo program signal in the FM baseband. The data transmission (baud) rate is comparatively low, yet it is quite robust because of data redundancy and effective error correction.

It is not within the scope of this Manual to cover the details of RDS subcarrier coding and modulation. For this, the reader is directed to the Specification appropriate to his location either the CENELEC EN50067 Specification for Europe or the United States NRSC Specification. Since the Manual will deal with specific implication of RDS implemented with the Radio Explorer II, it is assumed that the user is familiar with the RDS concept.

APPENDIX B

DOWNLOAD/UPLOAD FILES VIA FTP

In order for a connection to be established the following setting should be applied:

1. FTP Server Settings

The built-in FTP Server has four important parameters that should be configured: Command Port, Data Port, User name and Password. These parameters are to be used in the FTP client's connection configuration. Further information on how to change the FTP Server's settings and their respective default values can be found in the device's User manual.

WE RECOMMEND the usage of FileZilla (<https://filezilla-project.org>). This is a widespread open source software distributed free of charge, hence available for downloading from the Internet.

NOTE: The FTP Server can manage only one connection at a time. The FTP Server works in Passive mode. Hence, the FTP Client should also be set in passive mode.

2. IP Router and Port Translation Settings

If the connection to the device is made through a Network address translation (NAT) router or firewall, the port forwarding feature of the router should be configured. The port forwarding is usually set in the firewall section of the router's menu. As each router has different port forwarding procedure, we recommend you to refer to its complete manual. To allow proper data flow through the router, the FTP Command and FTP Data ports should be open.

NOTE: The FTP port numbers to be used in the port forwarding feature configuration can be found in the device.

3. Example of FTP Client (FileZilla) Settings

In some cases, FileZilla's "Quick connect" feature is not able to connect with the DEVA unit. That is why we recommend the device to be assigned in the program manually.

Enter the FTP Client and go to: **File> Site manager> New Site**. A dialog box requiring obligatory information about the device will appear. Fill in the needed information and press "OK".

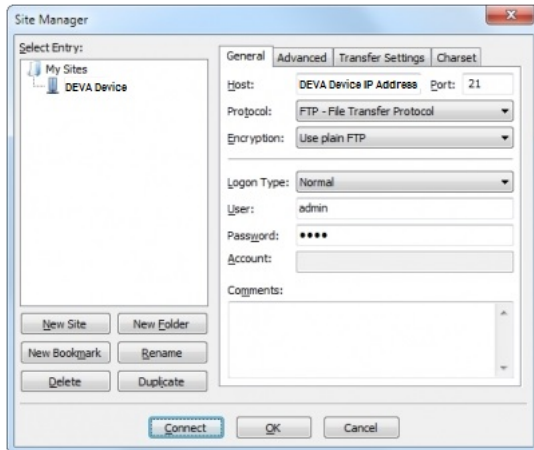

Select "Transfer Settings" sub-menu and apply the settings as shown below:

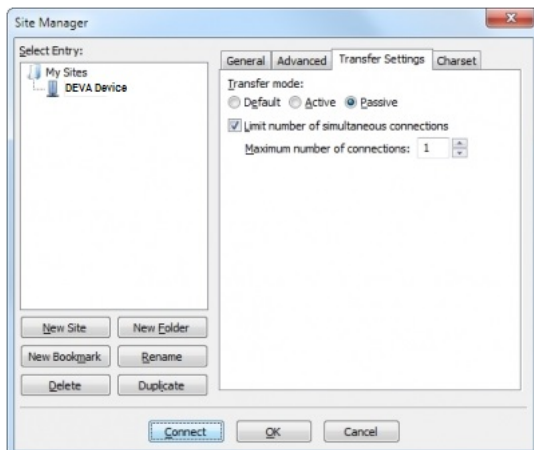

APPENDIX C.1

PTY Code Description Used in RBDS Mode – North America

PTY	Short Name	Description
1	News	News reports, either local or network in origin.
2	Information	Programming that is intended to impart advice.
3	Sports	Sports reporting, commentary, and/or live event coverage, either local or network in origin.
4	Talk	Call-in and/or interview talk shows either local or national in origin.
5	Rock	Album cuts.
6	Classic Rock	Rock oriented oldies, often mixed with hit oldies, from a decade or more ago.
7	Adult Hits	An up-tempo contemporary hits format with no hard rock and no rap.
8	Soft Rock	Album cuts with a generally soft tempo.
9	Top 40	Current hits, often encompassing a variety of rock styles.
10	Country	Country music, including contemporary and traditional styles.
11	Oldies	Popular music, usually rock, with 80% or greater non-current music.
12	Soft	A cross between adult hits and classical, primarily non-current softrock originals.
13	Nostalgia	Big-band music.
14	Jazz	Mostly instrumental, includes both traditional jazz and more modern “smooth jazz.”
15	Classical	Mostly instrumentals, usually orchestral or symphonic music.
16	Rhythm and Blues	A wide range of musical styles, often called “urban contemporary.”
17	Soft R and B	Rhythm and blues with a generally soft tempo.
18	Foreign Language	Any programming format in a language other than English.
19	Religious Music	Music programming with religious lyrics.
20	Religious Talk	Call-in shows, interview programs, etc. with a religious theme.
21	Personality	A radio show where the on-air personality is the main attraction.
22	Public	Programming that is supported by listeners and/or corporate sponsors instead of advertising.
23	College	Programming produced by a college or university radio station.
24	Spanish Talk	Call-in shows, interview programs, etc. in the Spanish language
25	Spanish Music	Music programming in the Spanish language
26	Hip-Hop	Popular music incorporating elements of rap, rhythm-and-blues, funk, and soul
27-28	Unassigned	
29	Weather	Weather forecasts or bulletins that are non-emergency in nature.
30	Emergency Test	Broadcast when testing emergency broadcast equipment or receivers. Not intended for searching or dynamic switching for consumer receivers. Receivers may, if desired, display “TEST” or “Emergency Test”.
31	Emergency	Emergency announcement made under exceptional circumstances to give warning of events causing danger of a general nature. Not to be used for searching - only used in a receiver for dynamic switching.

NOTE: These definitions can differ slightly between various language versions.

APPENDIX C.2

PTY Code Description Used in RDS Mode – Europe, Asia

PTY	Short Name	Description
1	News	Short accounts of facts, events and publicly expressed views, reportage and actuality.
2	Current affairs	Topical program expanding or enlarging upon the news, generally in different presentation style or concept, including debate, or analysis.
3	Information	Program the purpose of which is to impart advice in the widest sense.
4	Sport	Program concerned with any aspect of sport.
5	Education	Program intended primarily to educate, of which the formal element is fundamental.
6	Drama	All radio plays and serials.
7	Culture	Programs concerned with any aspect of national or regional culture.
8	Science	Programs about the natural sciences and technology.
9	Varied	Used for mainly speech-based programs usually of light-entertainment nature, not covered by other categories. Examples include: quizzes, games, personality interviews.
10	Pop	Commercial music, which would generally be considered to be of current popular appeal, often featuring in current or recent record sales charts.
11	Rock	Contemporary modern music, usually written and performed by young musicians.
12	Easy Listening	Current contemporary music considered to be “easy-listening”, as opposed to Pop, Rock or Classical, or one of the specialized music styles, Jazz, Folk or Country. Music in this category is often but not always, vocal, and usually of short duration.
13	Light classics	Classical Musical for general, rather than specialist appreciation. Examples of music in this category are instrumental music, and vocal or choral works.
14	Serious classics	Performances of major orchestral works, symphonies, chamber music etc., and including Grand Opera.
15	Other music	Musical styles not fitting into any of the other categories. Particularly used for specialist music of which Rhythm & Blues and Reggae are examples.
16	Weather	Weather reports and forecasts and Meteorological information.
17	Finance	Stock Market reports, commerce, trading etc.
18	Children’s programs	For programs targeted at a young audience, primarily for entertainment and interest, rather than where the objective is to educate.
19	Social Affairs	Programs about people and things that influence them individually or in groups. Includes: sociology, history, geography, psychology and society.
20	Religion	Any aspect of beliefs and faiths, involving a God or Gods, the nature of existence and ethics.
21	Phone In	Involving members of the public expressing their views either by phone or at a public forum.
22	Travel	Features and programs concerned with travel to near and far destinations, package tours and travel ideas and opportunities. Not for use for Announcements about problems, delays, or roadworks affecting immediate travel where TP/TA should be used.
23	Leisure	Programs concerned with recreational activities in which the listener might participate. Examples include, Gardening, Fishing, Antique collecting, Cooking, Food & Wine etc.
24	Jazz Music	Polyphonic, syncopated music characterized by improvisation.
25	Country Music	Songs which originate from, or continue the musical tradition of the American Southern States. Characterized by a straightforward melody and narrative story line.
26	National Music	Current Popular Music of the Nation or Region in that country’s language, as opposed to International ‘Pop’ which is usually US or UK inspired and in English.
27	Oldies Music	Music from the so-called “golden age” of popular music.
28	Folk Music	Music which has its roots in the musical culture of a particular nation, usually played on acoustic instruments. The narrative or story may be based on historical events or people.
29	Documentary	Program concerned with factual matters, presented in an investigative style.
30	Alarm Test	Broadcast when testing emergency broadcast equipment or receivers. Not intended for searching or dynamic switching for consumer receivers.. Receivers may, if desired, display “TEST” or “Alarm Test”.
31	Alarm	Emergency announcement made under exceptional circumstances to give warning of events causing danger of a general nature. Not to be used for searching - only used in a receiver for dynamic switching.

WARRANTY TERMS AND CONDITIONS

I. TERMS OF SALE: DEVA Broadcast Ltd. products are sold with an understanding of “full satisfaction”; that is, full credit or refund will be issued for products sold as new if returned to the point of purchase within 30 days following their receipt, provided that they are returned complete and in an “as received” condition.

II. CONDITIONS OF WARRANTY: The following terms apply unless amended in writing by DEVA Broadcast Ltd.

A. The Warranty Registration Card supplied with this product must be completed and returned to DEVA Broadcast Ltd. within 10 days of delivery.

B. This Warranty applies only to products sold “as new.” It is extended only to the original end-user and may not be transferred or assigned without prior written approval by DEVA Broadcast Ltd.

C. This Warranty does not apply to damage caused by improper mains settings and/or power supply.

D. This Warranty does not apply to damage caused by misuse, abuse, accident or neglect. This Warranty is voided by unauthorized attempts at repair or modification, or if the serial identification label has been removed or altered.

III. TERMS OF WARRANTY: DEVA Broadcast Ltd. products are warranted to be free from defects in materials and workmanship.

A. Any discrepancies noted within TWO YEARS of the date of delivery will be repaired free of charge, or the equipment will be replaced with a new or remanufactured product at DEVA Broadcast Ltd. option.

B. Parts and labor for factory repair required after the two-year Warranty period will be billed at prevailing prices and rates.

IV. RETURNING GOODS FOR FACTORY REPAIR:

A. Equipment will not be accepted for Warranty or other repair without a Return Authorization (RA) number issued by DEVA Broadcast Ltd. prior to its return. An RA number may be obtained by calling the factory. The number should be prominently marked on the outside of the shipping carton.

B. Equipment must be shipped prepaid to DEVA Broadcast Ltd.. Shipping charges will be reimbursed for valid Warranty claims. Damage sustained as a result of improper packing for return to the factory is not covered under terms of the Warranty and may occasion additional charges.

PRODUCT REGISTRATION CARD

- All fields are required, or warranty registration is invalid and void

Your Company Name _____

Contact _____

Address Line 1 _____

Address Line 2 _____

City _____

State/Province _____ ZIP/Postal Code _____

Country _____

E-mail _____ Phone _____ Fax _____

Which DEVA Broadcast Ltd. product did you purchase? _____

Product Serial # _____

Purchase date ____ / ____ / ____

Installation date ____ / ____ / ____

Your signature*

*Signing this warranty registration form you are stating that all the information provided to DEVA Broadcast Ltd. are truth and correct. DEVA Broadcast Ltd. declines any responsibility for the provided information that could result in an immediate loss of warranty for the above specified product(s).

Privacy statement: DEVA Broadcast Ltd. will not share the personal information you provide on this card with any other parties.