

IQOYA X/LINK range

IP audio codecs



User manual for: IQOYA X/LINK-LE, X/LINK-ST, X/LINK-DUAL, X/LINK-AES67

Applies from firmware version 3.01

January 2020

Date	Changes
June, 4, 2020	Appendix C,GPIO description: N.C and N.O pins were inverted.

Note regarding the presentation of this document:

IQOYA X/LINK devices feature two modes of use :

- *The 'Program Distribution' mode of use*
- *And the 'Remote Broadcasting' mode of use*

These two modes are described in the [WORKING PRINCIPLES](#) chapter.

In this document, the chapters specific to the "Program Distribution" mode of use are presented on a green background and the chapters specific to the "Remote Broadcasting" mode of use are presented on a blue background. The chapters which are relevant for both modes of use are presented on a white background.

TABLE OF CONTENTS

[INFORMATION FOR THE USER](#)

[1 KEY HARDWARE FEATURES](#)

[1.1 IQOYA X/LINK-LE](#)

[1.2 IQOYA X/LINK-ST](#)

[1.3 IQOYA X/LINK-DUAL](#)

[1.4 IQOYA X/LINK-AES67](#)

[2 KEY SOFTWARE FEATURES](#)

[2.1 Supported I/O channels](#)

[2.2 Standard features](#)

[2.3 Optional software features](#)

[2.4 Supported audio algorithms](#)

[3 PHYSICAL INTERFACES](#)

[3.1 IQOYA X/LINK-ST, X/LINK-DUAL and X/LINK-AES67 front Panel](#)

[3.1.1 LEDs](#)

[3.1.2 LCD display and keypad](#)

[3.1.3 SDHC card reader](#)

[3.1.4 Headphones output](#)

[3.1.5 Navigating menus on LCD display](#)

[3.2 IQOYA X/LINK/LE front Panel](#)

[3.2.1 LEDs](#)

[3.3 IQOYA X/LINK-ST, X/LINK-LE, X/LINK-DUAL back Panel](#)

[3.4 IQOYA X/LINK-AES67 back Panel](#)

[4 WORKING PRINCIPLES](#)

[4.1 Working principles in “Program Distribution” mode of use](#)

[4.1.1 IQOYA X/LINK-ST & X/LINK-LE](#)

[4.1.2 IQOYA X/LINK-DUAL](#)

[4.1.3 IQOYA X/LINK-AES67](#)

[4.1.4 Audio inputs and outputs](#)

[4.1.5 Programs](#)

[4.1.6 IP services](#)

[4.1.7 Audio buses](#)

[4.2 Working principles in “Remote Broadcasting” mode of use](#)

[4.2.1 IQOYA X/LINK-ST & X/LINK-LE](#)

[4.2.2 IQOYA X/LINK-DUAL](#)

[4.2.3 IQOYA X/LINK-AES67](#)

[4.2.4 Audio inputs and outputs](#)

[4.2.5 IP codec instances](#)

[4.2.6 Contacts and Address book](#)

[4.2.6 Call profiles and Call profile list](#)

[5 INSTALLATION](#)

[5.1 Grounding the IQOYA X/LINK](#)

[5.2 Connecting IQOYA X/LINK to the network](#)

[5.3 Enabling / disabling the hardware bypass function](#)

[5.4 Powering up IQOYA X/LINK](#)

[5.5 Steps to follow to configure IQOYA X/LINK in “Program Distribution” mode of use](#)

[5.6 Steps to follow to configure IQOYA X/LINK in “Remote Broadcasting” mode of use](#)

[6 Accessing IQOYA X/LINK WEB pages](#)

[7 Configuration from the WEB pages](#)

[8 WEB pages organization](#)

[8.1 WEB pages organization in “Program Distribution” mode of use](#)

[8.1.1 “Preferences” category of menus](#)

[8.1.1.1 Preferences -> System](#)

[8.1.1.1.1 Preferences -> System -> Properties](#)

[8.1.1.1.2 Preferences -> System -> Audio Clock](#)

[8.1.1.1.2.1 PTP clock source](#)

[8.1.1.1.2.2 Livewire \(Slave\)](#)

[8.1.1.1.3 Preferences -> System -> Audio setup](#)

[8.1.1.1.4 Preferences -> System -> Alarms setup](#)

- [8.1.1.1.5 Preferences -> System -> Logs](#)
- [8.1.1.1.6 Preferences -> System -> Download / Upload](#)
- [8.1.1.1.7 Preferences -> System -> SD card](#)
- [8.1.1.1.8 Preferences -> System -> SD card backup](#)
- [8.1.1.1.9 Preferences -> System -> Firmware update](#)
- [8.1.1.1.10 Preferences -> System -> Password](#)
- [8.1.1.1.11 Preferences -> System -> Shutdown / Restart](#)
- [8.2.3.1.11 Preferences -> System -> Switch mode of use](#)
- [8.1.1.2 Preferences -> Services](#)
 - [8.1.1.2.1 Preferences -> Services -> NTP](#)
 - [8.1.1.2.2 Preferences -> Services -> FTP](#)
 - [8.1.1.2.3 Preferences -> Services -> SSH](#)
 - [8.1.1.2.4 Preferences -> Services -> SNMP](#)
 - [8.1.1.2.5 Preferences -> Services -> HTTPS](#)
 - [8.1.1.2.6 Preferences -> Services -> Publish / Discover](#)
- [8.1.1.3 Preferences -> Network](#)
 - [8.1.1.3.1 Preferences -> Network -> LANx](#)
 - [8.1.1.3.2 Preferences -> Network -> VLAN](#)
 - [8.1.1.3.3 Preferences -> Network -> IP routing](#)
 - [8.1.1.3.4 Preferences -> Network -> HTTP stream proxy](#)
- [8.1.1.4 Preferences -> Auxiliary data](#)
 - [8.1.1.4.1 Preferences -> Auxiliary data -> Serial port](#)
 - [8.1.1.4.2 Preferences -> Auxiliary data -> GPIO](#)
 - [8.1.1.4.3 Preferences -> Auxiliary data -> UDP](#)
- [8.1.2 Audio I/Os category of menus](#)
 - [8.1.2.1 Audio I/O -> Input](#)
 - [8.1.2.1.1 Audio I/O -> Input -> VU meters](#)
 - [8.1.2.1.2 Audio I/O -> Input -> settings](#)
 - [8.1.2.2 Audio I/O -> Output](#)
 - [8.1.2.2.1 Audio I/O -> Output -> VU meters](#)
 - [8.1.2.2.2 Audio I/O -> Output -> settings](#)
 - [8.1.2.3 Audio I/O -> Audio Bus](#)
 - [8.1.2.3.1 Audio I/O -> Audio Bus -> Vu meters](#)
 - [8.1.2.3.2 Audio I/O -> Audio Bus -> Settings](#)
- [8.1.3 "Send" category of menus](#)
 - [8.1.3.1 Send -> Programs](#)
 - [8.1.3.2 Send -> IP services](#)
- [8.1.4 "Receive" category of menus](#)
 - [8.1.4.1 Receive -> IP services](#)

[8.1.4.2 Receive -> Programs](#)

[8.1.5 Status](#)

[8.2 WEB pages organization in "Remote Broadcasting" mode of use](#)

[8.2.1 "Operations" page](#)

[8.2.1.1 Call window when no communication is in progress](#)

[8.2.1.2 Place a call](#)

[8.2.1.3 Accept or reject a call](#)

[8.2.1.5 Call window when a communication is in progress](#)

[8.2.1.6 Hang up a call](#)

[8.2.2 "Connections" category of menus](#)

[8.2.2.1 Connections -> Network](#)

[8.2.2.1.1 Connections -> Network -> ETHx](#)

[8.2.2.1.2 Connections -> Network -> VLAN](#)

[8.2.2.1.3 Connections -> Network -> IP routing](#)

[8.2.2.2 Connections -> IP codecs](#)

[8.2.2.2.1 Connections -> IP codecs -> SIP accounts](#)

[8.2.2.2.1.1 Declare a new SIP account](#)

[8.2.2.2.1.2 Edit a SIP account](#)

[8.2.2.2.1.3 Delete a SIP account](#)

[8.2.2.2.2 Connections -> IP codecs -> IP codec configuration](#)

[8.2.2.2.2.1 Create a new IP codec instance](#)

[8.2.2.2.2.2 Enable IP codec instances](#)

[8.2.2.2.2.3 Edit an IP codec instance](#)

[8.2.2.2.2.4 Disable IP codec instances](#)

[8.2.2.2.2.5 Delete IP codec instances](#)

[8.2.2.3 Connections -> Profiles](#)

[8.2.2.3.1 Add a call profile](#)

[8.2.2.3.2 Edit a call profile](#)

[8.2.2.3.2 Delete call profiles](#)

[8.2.3 "Advanced settings" category of menus](#)

[8.2.3.1 Advanced settings -> System](#)

[8.2.3.1.1 Advanced settings -> System -> Properties](#)

[8.2.3.1.2 Advanced settings -> System -> Audio Clock](#)

[8.2.3.1.2.1 PTP clock source](#)

[8.2.3.1.2.2 Livewire \(Slave\)](#)

[8.2.3.1.3 Advanced settings -> System -> Audio setup](#)

[8.2.3.1.4 Advanced settings -> System -> Logs](#)

[8.2.3.1.5 Advanced settings -> System -> Download / Upload](#)

[8.2.3.1.6 Advanced settings -> System -> SD card](#)

[8.2.3.1.7 Advanced settings -> System -> SD card backup](#)

[8.2.3.1.8 Advanced settings -> System -> Firmware & License update](#)

[8.2.3.1.9 Advanced settings -> System -> Password](#)

[8.2.3.1.10 Advanced settings -> System -> Shutdown / Restart](#)

[8.2.3.1.11 Advanced settings -> System -> Switch mode of use](#)

[8.2.3.2 Advanced settings -> services](#)

[8.2.3.2.1 Advanced settings -> services-> NTP](#)

[8.2.3.2.2 Advanced settings -> services-> FTP](#)

[8.2.3.2.3 Advanced settings -> services-> SSH](#)

[8.2.3.2.4 Advanced settings -> services-> HTTPS](#)

[8.2.3.2.5 Advanced settings -> services-> Publish / Discover](#)

[8.2.4 Audio I/Os category of menus](#)

[9 Managing sound files and playlists via FTP](#)

[10 Specifications](#)

[10.1 IQOYA X/LINK-LE and X/LINK-ST](#)

[10.1.1 CONFIGURATION](#)

[10.1.2 CONNECTIVITY](#)

[10.1.3 ANALOG INPUTS](#)

[10.1.4 ANALOG LINE OUTPUTS](#)

[10.1.5 AES/EBU INPUTS](#)

[10.1.6 AES/EBU OUTPUTS](#)

[10.1.7 AES67/RAVENNA](#)

[10.1.8 Livewire](#)

[10.1.9 HEADPHONES OUTPUT](#)

[10.1.10 OTIONAL SYNCHRONIZATION INPUTS](#)

[10.1.11 ANALOG AUDIO PERFORMANCES](#)

[11 APPENDIX C: GPIO's CONNECTORS](#)

[12 APPENDIX D: SERIAL PORT \(RS232 ON DB9\)](#)

[13 APPENDIX E: TYPICAL LATENCY VALUES](#)

[14 APPENDIX H: AVAILABLE FEC](#)

[15 APPENDIX I: REDUNDANT DUAL STREAMING](#)

Important Safety Information: read carefully before using this equipment!

Follow these instructions and keep them in a safe place! Keep in mind that damages due to failure to observe the instructions contained in this manual are not covered by warranty.

Instructions importantes de sécurité: lire soigneusement avant d'utiliser l'équipement!

Lisez et suivez ces instructions. Conservez les pour consultation ultérieure! Les dommages dus au non-respect des instructions contenues dans ce manuel ne sont pas couverts par la garantie.

Wichtige Sicherheitshinweise: vor Inbetriebnahme des Gerätes sorgfältig lesen!

Befolgen Sie die Anweisungen und bewahren Sie sie für spätere Fragen auf! Bei Schäden, die durch Nichtbeachten dieser Bedienungsanleitung verursacht werden, erlischt der Garantieanspruch!



Throughout this manual, the lightning bolt triangle is used to alert the user to the risk of electric shock.



The exclamation point triangle is used to alert the user to important operating or maintenance instructions.

Do Not Open the Cabinet

There are no user-serviceable components inside this product. Opening the cabinet may present a shock hazard, and any modification to the product will void your warranty. If it is necessary to open the device for maintenance or advanced configuration purposes, this is to be done by qualified personnel only after disconnecting the power cord and network cables!

Power supply

The device is to be connected only to a power supply as specified in this manual and marked on the equipment.

This equipment must be earthed!

Do not block any of the ventilation openings!

Humidity

To reduce the risk of fire or shock, do not expose this device to rain or moisture. Do not place objects filled with liquid on this device.

Installation Location

To ensure proper operation and to avoid safety hazards, the device must be installed in a 19" rack mount chassis. The electrical installation of the building should dispose of easily accessible disconnecting means in the immediate vicinity of the device.

If rack installation is not possible, place it on a firm and level surface. The use of a supply lead with a power plug respecting the legal standards in the country of use is obligatory. The plug shall be easily accessible in case of a problem.

Avoid installation in extremely hot or cold locations, or in an area that is exposed to direct sunlight or heating equipment. Avoid moist or humid locations.

Connection of this product to an IT power supply system is only in Norway.

Cleaning

Clean only with a soft, dry cloth. If necessary, after disconnecting the unit's cables, wipe it with a soft cloth dampened with mild soapy water, then with a fresh cloth with clean water. Wipe dry immediately with a dry cloth. NEVER use benzene, aerosol cleaners, thinner, alcohol or any other volatile cleaning agent. Do not use abrasive cleaners, which may damage the finish of metal or other parts.

Refer all servicing to qualified service personnel.

Service is required when the apparatus has been damaged in any way, such as power supply cord or plug is damaged, liquid has been spilled, the apparatus has been exposed to rain or moisture, does not operate normally, or has been dropped.

Moving the device

Before moving the unit, be certain to disconnect any

Ne pas ouvrir l'appareil

L'ouverture du coffret peut produire un risque de choc électrique, et toute modification du produit annule votre garantie. S'il est nécessaire d'ouvrir l'appareil pour l'entretien ou la configuration avancée, cela doit être fait par du personnel qualifié, après avoir débranché le cordon d'alimentation et les câbles réseaux !

Alimentation

Il est primordial de connecter l'appareil à une alimentation électrique telle que spécifiée dans ce manuel d'utilisateur et sur le matériel même. Cet équipement doit être raccordé à la terre ! N'obstruer aucune ouverture de ventilation !

Humidité

Afin de réduire les risques de feu ou de choc, n'exposez pas cet appareil à la pluie ou l'humidité. Ne placez pas d'objet contenant un liquide sur l'appareil.

Installation, mise en place

Afin d'assurer le fonctionnement correct et de minimiser les risques potentiels liés à la sécurité, l'appareil doit être installé dans un châssis 19 pouces. Si cela ne vous est pas possible, placez-le sur une surface solide et plane. Prévoir dans l'installation électrique du bâtiment un dispositif de sectionnement aisément accessible et à proximité immédiate de l'appareil.

L'utilisation d'un câble d'alimentation avec une fiche de prise de courant respectant les normes en vigueur dans le pays d'utilisation est obligatoire. De plus la fiche de prise de courant doit être aisément accessible en cas de problème.

Évitez une installation dans des endroits très chauds ou très froids ainsi que dans des lieux exposés directement au soleil. Évitez les lieux présentant un excès d'humidité.

Le raccordement de ce produit à un régime d'alimentation IT n'est possible qu'en Norvège.

Nettoyage

Nettoyez uniquement avec un chiffon doux et sec. Si nécessaire, après avoir débranché le cordon d'alimentation, essuyez-le avec un chiffon doux humidifié avec de l'eau savonneuse puis rincez le à l'aide d'un chiffon propre et d'eau claire. Séchez-le immédiatement avec un chiffon sec. N'utilisez JAMAIS d'essence, de nettoyeurs en aérosols, d'alcool ou tout autre agent nettoyant volatile. N'utilisez pas de produits nettoyants abrasifs qui pourraient endommager les finitions métalliques ou d'autres pièces.

Réparation

Lorsque l'appareil a été endommagé quelle qu'en soit la cause ou qu'il ne fonctionne pas normalement, toute réparation doit être effectuée par du personnel qualifié. Avant de transporter l'unité, assurez-vous d'avoir bien déconnecté le cordon d'alimentation ainsi que tous les

Gerät nicht öffnen

Öffnen des Geräts kann eine Gefährdung durch Stromschlag und Erlöschen der Garantie zur Folge haben. Reparaturarbeiten und Änderungen der Hardwarekonfiguration dürfen nur von qualifiziertem Personal nach Entfernen der Strom- und Netzkabel durchgeführt werden.

Stromversorgung

Das Gerät darf nur mit der in dieser Bedienungsanleitung und auf dem Gerät angegebenen Stromversorgung betrieben werden.

Erdung ist zu gewährleisten!

Belüftungsschlitze nicht verdecken!

Wasser und Feuchtigkeit

Um Brand- oder Stromschlagrisiken zu vermeiden, darf das Gerät nicht mit Feuchtigkeit in Berührung kommen.

Aufbau des Geräts

Um den einwandfreien Betrieb zu gewährleisten und Sicherheitsrisiken zu vermeiden, sollte das Gerät in einem 19-Zoll Baugruppenrahmen montiert werden. Die elektrische Installation des Gebäudes sollte über einen leicht zugänglichen Trennschalter in unmittelbarer Nähe des Geräts verfügen. Nur wenn die Installation im Rack nicht möglich ist, stellen Sie das Gerät auf einen festen, waagerechten Untergrund.

Die Verwendung eines Anschlußkabels und eines Steckers, die die im Benutzungsland gültigen Normen erfüllen, ist obligatorisch. Des Weiteren muß die Steckdose für einen eventuellen Problemfall leicht zugänglich sein.

Meiden Sie Standorte in der Nähe von Wärme- oder Feuchtigkeitsquellen sowie direkte Sonneneinstrahlung. Anschluß dieses Produktes an eine spezielle IT-Stromversorgung ist nur in Norwegen genehmigt.

Reinigen des Geräts

Säubern Sie das Gerät nur mit einem weichen, trockenen Tuch. Bei Bedarf verwenden Sie ein mit mildem Seifenwasser befeuchtetes Tuch, nachdem Sie die Netzanschlusskabel aus der Steckdose gezogen haben, anschließend ein weiches, mit klarem Wasser befeuchtetes Tuch. Trocken Sie das Gerät sofort im Anschluß. Keinesfalls Benzol, Verdüner oder sonstige starke Lösungsmittel oder Scheuerreiniger verwenden, da hierdurch das Gehäuse beschädigt werden könnte.

Lassen Sie etwaige Reparaturen nur von qualifizierten Fachleuten durchführen!

Sollten das Netzkabel oder der Netzstecker beschädigt sein, oder sollte das Gerät selbst beschädigt worden sein (z. B. durch Eindringen von Feuchtigkeit durch Fall auf den Boden), oder sollte es nicht ordnungsgemäß funktionieren oder eine deutliche Funktionsabweichung aufweisen, so ist es von qualifizierten Fachleuten zu reparieren.

cables that connect with other components.	câbles la reliant à d'autres appareils.	
--	---	--

INFORMATION FOR THE USER

“This equipment has been tested and found to comply with the limits for a Class A digital device, pursuant to part 15 of the FCC Rules. These limits are designed to provide reasonable protection against harmful interference when the equipment is operated in a commercial environment. This equipment generates, uses, and can radiate radio frequency energy and, if not installed and used in accordance with the instruction manual, may cause harmful interference to radio communications. Operation of this equipment in a residential area is likely to cause harmful interference in which case the user will be required to correct the interference at his own expense.”

Warning
This is a class A product. In a domestic environment this product may cause radio interference in which case the user may be required to take adequate measures.

CAN ICES-3 (A) / NMB-3 (A)

User safety	EMC
<p>European Directive 2006/95/EC "Low Voltage Directive Europe: EN60950-1 (2006+A1/2009+A1/2010+A12/2011+A2/2013) International: IEC 60950-1 (2005+A1/2009+A2/2013)</p>	<p>European Directive: EMC 2004/108/EC Radio disturbance : <i>International:</i> CISPR22 (2008) Class A IEC 61000-6-3 (2006+A1/2010) <i>European :</i> EN55022 Class A (2010) Requirements for Information Technology Equipment (ITE) EN 61000-6-3 (2007+A1/2011) Immunity: <i>International :</i> CISPR24 (2010) IEC 61000-6-2 (2005) <i>European :</i> EN55024 (2010) (ITE) EN 61000-6-2 (2005) Harmonics: <i>International :</i> IEC 61000-3-2 (2005 + A1/2008 + A2/2009) <i>European :</i> EN61000-3-2 (2006 + A1/2009 + A2/2009) Voltage changes : <i>International :</i> IEC 61000-3-3 (2013) <i>European :</i> EN 61000-3-3 (2013) United States: CFR 47, FCC Part 15, Subpart A (Class A Digital Device) & Industry Canada ICES-003 (Issue 5/2012)</p>
<p>RoHS European directive 2011/65/EU aka "RoHS"</p>	<p>Note: to comply with standard EN55024, use shielded network cables!</p>

In order to guarantee compliance with the above standards in an installation, the following must be done:

- the provided cables must not be modified.
- additional cables used must have their respective shield connected to each extremity.

- Attach a ground wire to the chassis (ideally the ground wire has a ring terminal). Connect the other end of the ground wire to a good electrical ground point.

The limits specified in the standards are designed to provide reasonable protection against harmful interference in an industrial installation. This equipment generates, uses and can radiate radio frequency energy and, if not installed and used in accordance with the instruction, may cause harmful interference to radio communications. However, there is no guarantee that interference will not occur in a particular installation.

If this equipment does cause harmful interference to radio or television reception, which can be determined by turning the equipment off and on, the user is encouraged to try to correct the interference by one or more of the following measures:

- reorient or relocate the receiving antenna.
- increase the separation between the equipment and the receiver.
- connect the equipment into an outlet on a circuit different from that to which the receiver is connected.
- consult the dealer or an experienced audio/television technician for help.

Note:

Connecting this device to peripheral devices that do not comply with CLASS A requirements or using an unshielded peripheral data cable could also result in harmful interference to radio or television reception. The user is cautioned that any changes or modifications not expressly approved by the party responsible for compliance could void the user's authority to operate this equipment. To ensure that the use of this product does not contribute to interference, it is necessary to use shielded I/O cables.

Copyright 2015 - Digigram. All rights reserved.

No portion of this manual may be reproduced without prior written consent from Digigram. The copyright protection claimed here includes photocopying, translation and/or reformatting of the information contained in this manual.

While every effort has been made to ensure accuracy, Digigram is not responsible for errors, omissions or typos, and reserves the right to make improvements or changes in the products and programs described without notice.

Digigram and the Digigram logo, visiblu and the visiblu logo, and IQOYA are registered trademarks or trademarks of Digigram S.A.. HE-AAC and AAC-(E)LD are registered trademarks or trademarks of Fraunhofer IIS. All other trademarks are property of their respective holders.

You have just acquired a Digigram IQOYA X/LINK and we congratulate you!

The manual at hand will guide through installation, configuration, and operation. For any software related issue, please refer to the specific documentation provided in its online help.

1 KEY HARDWARE FEATURES

1.1 IQOYA X/LINK-LE

- 1U rack
- Two internal redundant power supply units (2x220 VAC, optionally 220VDC / -48VDC)
- 4 Ethernet ports via RJ-45 connectors. 1 x 100 Mbits/s, and 3 x 100/1000 Mbits/s ports
- 2 balanced analog line inputs and outputs
- 1 AES/EBU input and output
- Switchable hardware by-pass on inputs to outputs in case of power supply failure
- 1 RS232 port for auxiliary data tunneling
- 8 GPIO's, or 4 GPIO's if the 10 MHz / 1 PPS external synchro input(s) are used (optional)
- External synchronization: AES/EBU input, 10 MHz (Optional), PTP clock, Livewire clock
- Status LEDs
- SDHC card reader
- 6.35mm headphones jack with volume knob and codec input/output selection

1.2 IQOYA X/LINK-ST

- 1U rack
- Two internal redundant power supply units (2x220 VAC, optionally 220VDC / -48VDC)
- 4 Ethernet ports via RJ-45 connectors. 1 x 100 Mbits/s, and 3 x 100/1000 Mbits/s ports
- 2 balanced analog line inputs and outputs
- 1 AES/EBU input and output
- Switchable hardware by-pass on inputs to outputs in case of power supply failure
- 1 RS232 port for auxiliary data tunneling
- 8 GPIO's, or 4 GPIO's if the 10 MHz / 1 PPS external synchro input(s) are used (optional)
- External synchronization: AES/EBU input, 10 MHz (optional), PTP clock, Livewire clock
- Front panel LCD display and keypad
- Status LEDs
- SDHC card reader
- 6.35mm headphones jack with volume knob and codec input/output selection

1.3 IQOYA X/LINK-DUAL

- 1U rack
- Two internal redundant power supply units (2x220 VAC, optionally 220VDC / -48VDC)
- 4 Ethernet ports via RJ-45 connectors. 1 x 100 Mbits/s, and 3 x 100/1000 Mbits/s ports
- 4 balanced analog line inputs and outputs
- 2 AES/EBU input and output
- Switchable hardware by-pass on the first stereo inputs to outputs in case of power supply failure
- 1 RS232 port for auxiliary data tunneling
- 4 GPIO's if the 10 MHz / 1 PPS external synchro input(s) are used (optional)
- External synchronization: AES/EBU input, 10 MHz (optional), PTP clock, Livewire clock
- Front panel LCD display and keypad
- Status LEDs
- SDHC card reader

- 6.35mm headphones jack with volume knob and codec input/output selection

1.4 IQOYA X/LINK-AES67

- 1U rack
- Two internal redundant power supply units (2x220 VAC, optionally 220VDC / -48VDC)
- 4 Ethernet ports via RJ-45 connectors. 1 x 100 Mbits/s, and 3 x 100/1000 Mbits/s ports
- 1 RS232 port for auxiliary data tunneling
- 8 GPIO's, or 4 GPIO's if the 10 MHz / 1 PPS external synchro input(s) are used (optional)
- External synchronization: 10 MHz (optional), PTP clock, Livewire clock
- Front panel LCD display and keypad
- Status LEDs
- SDHC card reader
- 6.35mm headphones jack with volume knob and codec input/output selection

2 KEY SOFTWARE FEATURES

2.1 Supported I/O channels

	Number of mono input / output channels of the codec	Type of audio I/Os
X/LINK-ST & X/LINK-LE	2 / 2	Analog, AES/EBU, AES67, Ravenna, Livewire (standard mode)
X/LINK-DUAL	4 / 4	Analog, AES/EBU, AES67, Ravenna, Livewire (standard mode)
X/LINK-AES67	From 2 / 2 to 16 / 16	AES67, Ravenna, Livewire (standard mode)

2.2 Standard features

- Two modes of use: “Program Distribution” mode and “Remote Broadcasting” mode
- Simultaneous encoding, decoding
- Multi-format encoding and multi-protocol streaming of each input.
- Support for SIP signaling protocol including SIP presence information
- Support for symmetric RTP
- Contact list management
- Call profile management
- Possibility to place calls choosing the correspondent in an address book and the call profile in a call profile list and to accept or deny incoming calls.
- Support of unicast, multi-unicast, multicast, multi-multicast addressing
- Support of IGMPv3
- MPEG-TS/IP streaming

- VLAN Tagging + DSCP
- Support of DHCP
- Asymmetric algorithmic encoding/decoding
- 3 decoding priorities per output program, with choice of the audio source on each priority: IP service (RTP, UDP, HTTP), file, playlist and audio input
- Automatic switching to a lower decoding priority in case of upper priority failure
- Possibility to disable/enable any defined priority
- Possibility to stop streaming upon input silence detection with adjustable silence threshold and duration.
- Decoding of a stereo source to a mono output, with possibility to mix left and right channels
- Dual port redundant streaming with optional time diversity up to 3 second
- Selectable FECs for ACIP RTP streams (from +10% to +100% IP bandwidth)
- Pro MPEG Cop#3 FEC for MPEG-TS streams (line, columns)
- Automatic audio format detection on the decoder
- Real-time metrics on network path quality (jitter, lost packets, duplicated packets, disordered packets) for the primary stream as well as for the FEC stream.
- Adjustable jitter buffer
- Management of lost packets, disordered packets, duplicated packets, and AAC error concealment
- In-band auxiliary data tunneling: serial and status (serial via RS232 or UDP, Status via GPIOs or UDP)
- WEB user rights management
- NTP synchronization (date and time)
- Save / load full codec configuration
- Save / load audio configuration
- Remote firmware update
- Audio still active during firmware upload
- Firmware version N and N-1 locally stored
- SNMPv2c SET, GET, Traps

2.3 Optional software features

- IP streams transcoding. X/LINK, X/LINK-DUAL, X/LINK-AES67
- Multi-protocol streaming: X/LINK-LE
- NTP based audio synchronization
- 1+1 redundancy

2.4 Supported audio algorithms

Included	Optional
<ul style="list-style-type: none"> • linear 16/20/24-bit PCM • ITU G.711/722 • ISO MPEG-1/2 Layer I, Layer II, Layer III • AAC-LC, HE-AACv1 (LC+SBR), HE-AACv2(LC+SBR+PS), AAC-LD, AAC-ELD 	

<ul style="list-style-type: none"> Opus 	
--	--

3 PHYSICAL INTERFACES





3.1 IQOYA X/LINK-ST, X/LINK-DUAL and X/LINK-AES67 front Panel



3.1.1 LEDs

PSU1	Status of the first internal power supply unit. Blue if PSU is ok. Off for PSU failure.
PSU2	Status of the second internal power supply unit. Blue if PSU is ok. Off for PSU failure.
Network	Green: all the enabled network interfaces are up. Orange: at least one of the enabled network interface is down Red: no network connection on all the network interfaces
Send	Green: "Send" activity is normal. Red: Failure on a sender.
Receive	Green: "Receive" activity is normal Red: at least one active receiver has no audio source
System	Green flashing if unit is ok.
Fail-over	Green in case at least one output program has switched to a backup audio source
SD	Flashes when SDHC card is accessed

3.1.2 LCD display and keypad

-  Next menu or sub-menu
-  Previous menu or sub-menu
-  Previous item in the menu, or increase the selected value
-  Next item in the menu, or decrease the selected value

 Validate the selected action

3.1.3 SDHC card reader

Supports SDHC cards, used for:

- saving/loading of the codec configuration
- Storing backup playlists and sound files

3.1.4 Headphones output

Allows audio monitoring.

The push button allows the selection of the audio source to be monitored.

For IQOYA X/LINK-ST and X/LINK-LE: encoder input, decoder output

For X/LINK-DUAL and X/LINK-AES67, it selects the audio that is assign to vu-meter A or vu-meter B. This assignment is made from the LCD front panel and keypad.

3.1.5 Navigating menus on LCD display

Use the arrow keys to navigate in the menus, and the Ok key to confirm a choice.

System (Home page)	Eth1	Eth2	Eth3	Eth3	Monitoring A(*)	Monitoring B(*)	Status	(**)
Host Name	Enable	Enable	Enable (yes)	Enable	Ana IN1 L Ana IN1 R	Ana OUT1 L Ana OUT1 R	Clock source: internal, AES IN1, AES IN2, PTP, 10 mHz Valeur (ex: 48000 Hz)	
Device Name	IPv4 @	IPv4 @	IPv4 @	IPv4 @	AES IN1 L AES IN1 R	AES OUT1 L AES OUT1 R	PTP OFF, Sync, Eth, source IP@	
System Time	Speed Mode	Speed Mode	Speed Mode	Speed Mode	Ana IN2 L Ana IN2 R	Ana OUT2 L Ana OUT2 R	SNMP: On / Off	
System Date	Link Status	Status	Status	Status	AES IN2 L AES IN2 R	AES OUT2 L AES OUT2 R	FTP: On/Off	
NTP Server URL1	Mac @	Mac @	Mac @	Mac @	AES67 IN1 L AES67 IN1 R	AES67 OUT1 L AES67 OUT1 R	NTP date and time On/Off	
NTP Server URL2	DHCP	DHCP	DHCP	DHCP	AES67 IN2 L AES67 IN2 R	AES67 OUT2 L AES67 OUT2 R	Audio Synchro on NTP On / Off - Sync / Not sync	
Serial Number	Subnet mask	Subnet mask	Subnet mask	Subnet mask	AudioBus1 L AudioBus1 R	AudioBus1 L AudioBus1 R	Audio synchro on PTP On / Off - Sync / Not sync	
Firmware version	Gateway	Gateway	Gateway	Gateway	AudioBus2 L AudioBus2 R	AudioBus2 L AudioBus2 R	Clock source: internal, AES IN1, AES IN2, PTP, 10 mHz Valeur (ex: 48000 Hz)	
Analog bypass / AES bypass	Primary DNS	Primary DNS	Primary DNS	Primary DNS				
Apply factory	Alternate	Alternate	Alternate	Alternate				

settings	DNS	DNS	DNS	DNS			
Restart							
Halt							
Remount SD card							
Unmount SD card							
Copy config to SD							
Restore config from SD							
Firmware update							
Screen Dimmer							

(*) Note about Monitoring.

The name of the inputs and outputs displayed on the LCD screen are the names configured from the inputs and outputs settings WEB pages.

() The following menus are only available in “Remote Broadcasting” mode of use:**

Select codec	(1) Call C<#N>	(2) Contacts C<#N>	(3) Recent calls C<#N>	(4) Profiles C<#N>
Codec instance #1: <I/O channels>: <Contact name> <SIP address or RTP listening port> Ok key leads to submenu (1)	CALL/ HANGUP <Contact to be called>	Contact entry #1: <Contact Name> <SIP address or IP address (****)>	Recent call #1: <Name of the remote> <SIP address or IP address (****)>	Call profile #1: <Call profile name>
Codec instance #2: <I/O channels>: <Contact name> <SIP address or RTP listening port> Ok key leads to submenu (1)	SELECT CONTACT (***) <Selected contact> Ok key leads to submenu (2)	Contact entry #2: <Contact Name> <SIP address or IP address (****)>	Recent call #2: <Name of the remote> <SIP address or IP address (****)>	Call profile #2: <Call profile name>
⋮	RECENT CALLS (***) <Selected recent call> Ok key leads to submenu (3)	⋮	⋮	⋮
Codec instance #N: <I/O channels>: <Contact name> <SIP address or RTP listening port> Ok key leads to submenu (1)	SELECT PROFILE (***) <Selected profile> Ok key leads to submenu (4)	Contact entry #N: <Contact Name> <SIP address or IP address (****)>	Recent call #N: <Name of the remote> <SIP address or IP address (****)>	Call profile #N: <Call profile name>
	LAST MESSAGE <Message following a call failure>			
	CONTACT NAME <Contact name of this codec>			
	REGISTRATION NAME <SIP address of this codec>			

(***) Items not available during a communication.

(****) Depending on whether the contact is accessible via SIP or Symmetric RTP

3.2 IQOYA X/LINK/LE front Panel



3.2.1 LEDs

PSU1	Status of the first internal power supply unit. Blue if PSU is ok. Off for PSU failure.
PSU2	Status of the second internal power supply unit. Blue if PSU is ok. Off for PSU failure.
Power	Green if internal power is ok
Send	Green: Send activity is normal. Red: at least one active sender has a failure
Receive	Green: Receive activity is normal Red: at least one active receiver has no audio source
System	Green flashing if unit is ok.
Fail-over	Green in case at least one output program has switched to a backup audio source
SD	Flashes when SDHC card is accessed

3.3 IQOYA X/LINK-ST, X/LINK-LE, X/LINK-DUAL back Panel

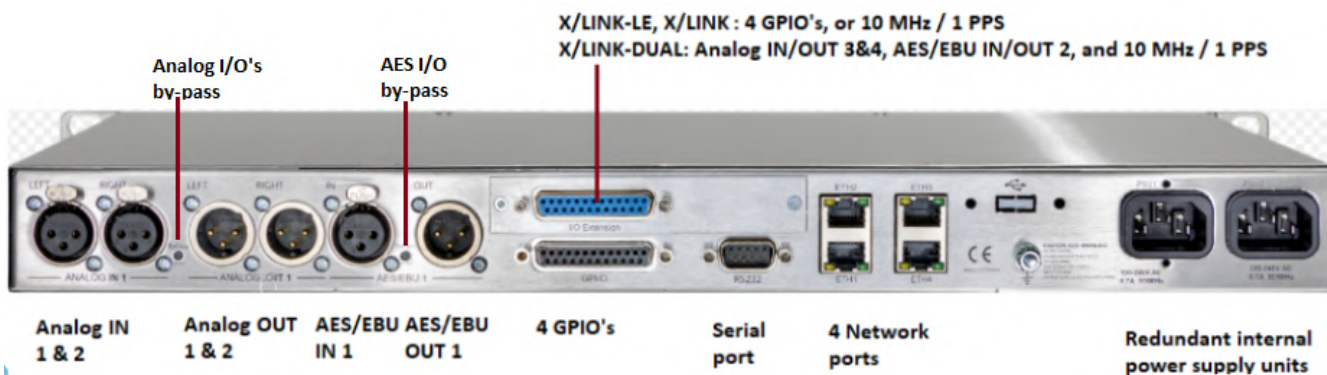

3.4 IQOYA X/LINK-AES67 back Panel

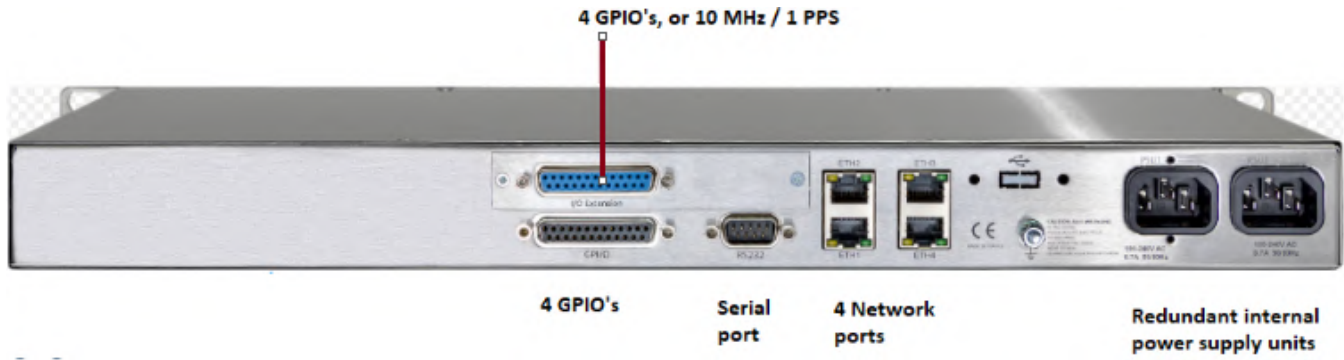

4 WORKING PRINCIPLES

IQOYA X/LINK features two modes of use :

- The ‘Program Distribution’ mode of use: In this mode, the available functions and the graphical user interfaces are suitable for the needs of fixed installations like STL and SSL links, delivery of WEB radios to CDNs, program delivery to DVB/cable operators, IP audio transcoding, etc ...
- The ‘Remote Broadcasting’ mode of use: In this mode, the available functions and the graphical user interfaces are suitable for the needs of temporary audio over IP connections like live remote broadcasts, intercom, etc ...

At first power up, the user is prompted to choose the mode of use either from the front panel (except IQOYA X/LINK-LE) or from the configuration web interface. Later it is possible to switch from one mode to another from the configuration web pages.

4.1 Working principles in “Program Distribution” mode of use

4.1.1 IQOYA X/LINK-ST & X/LINK-LE

IQOYA X/LINK allows at the same time:

- Encoding two audio channels in multiple audio formats, and streaming over IP
- Decoding IP audio streams to two output channels
- Transcoding IP audio streams (optional)

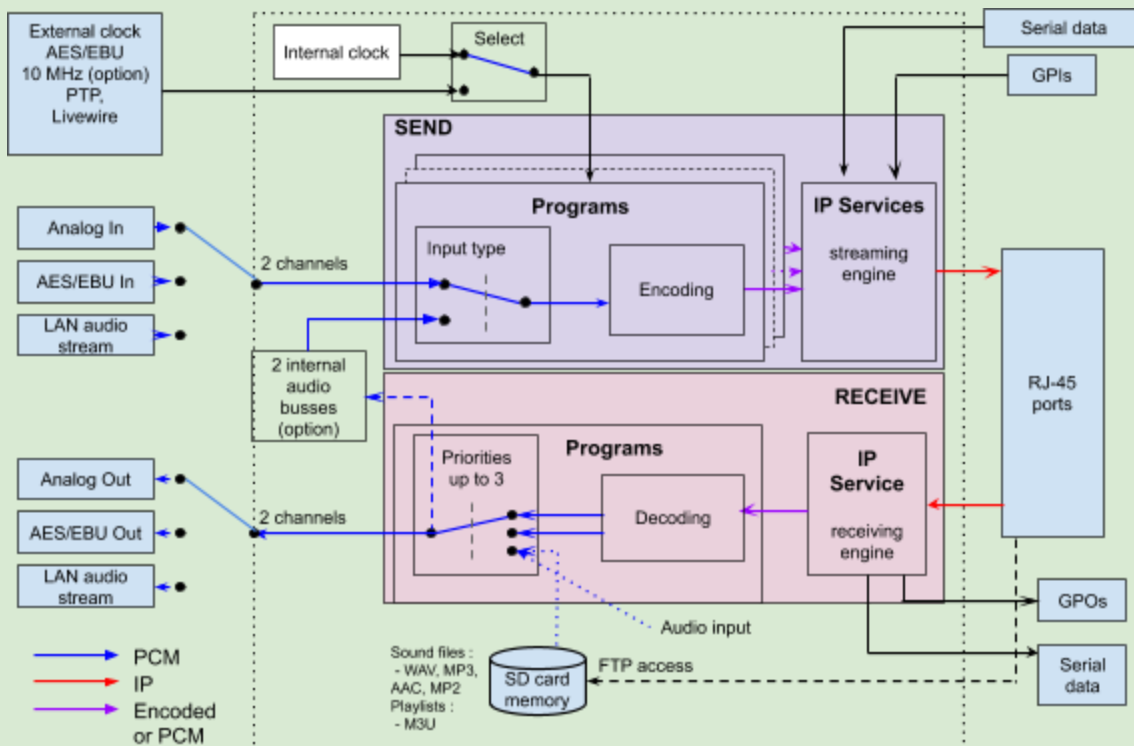

Schematic diagram of IQOYA X/LINK-ST & X/LINK-LE

4.1.2 IQOYA X/LINK-DUAL

IQOYA X/LINK-DUAL allows at the same time:

- Encoding four audio channels in multiple audio formats, and streaming over IP
- Decoding IP audio streams to four output channels
- Transcoding IP audio streams (optional)

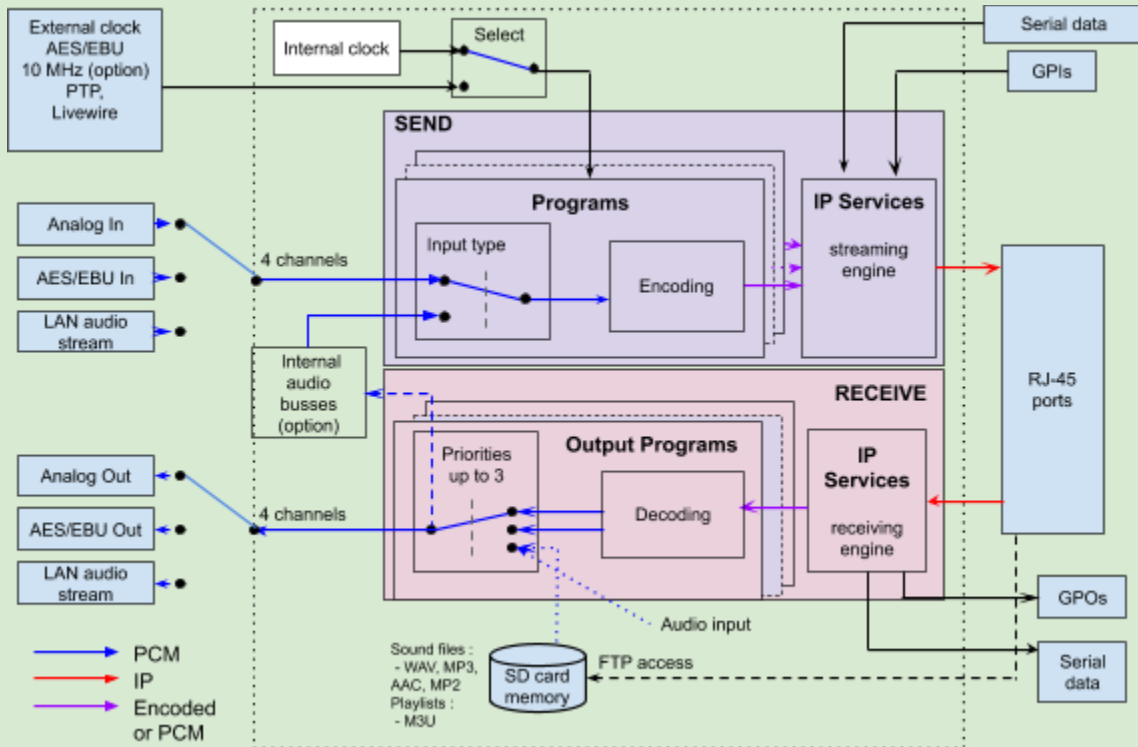

Schematic diagram of IQOYA X/LINK-DUAL

4.1.3 IQOYA X/LINK-AES67

IQOYA X/LINK-AES67 allows at the same time:

- Encoding 16 audio channels in multiple audio formats, and streaming over IP
- Decoding IP audio streams to 16 output channels
- Or transcoding IP audio streams (optional)

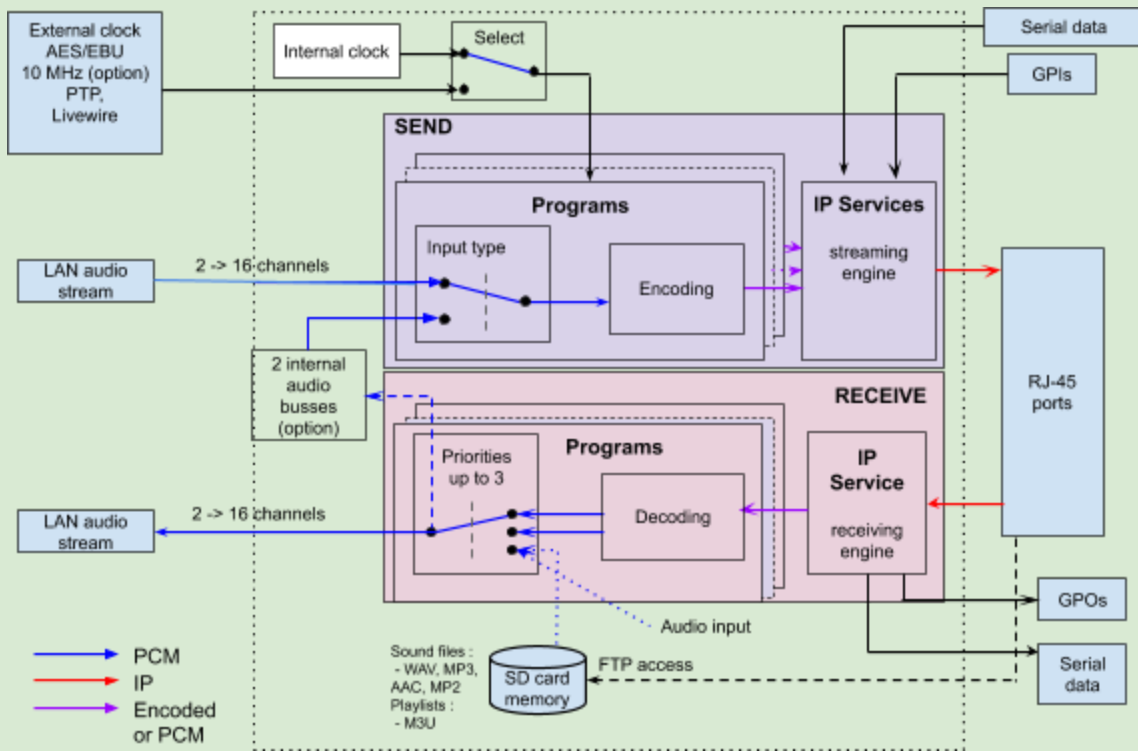

Schematic diagram of IQOYA X/LINK-AES67

4.1.4 Audio inputs and outputs

The audio inputs receive the audio signals to be encoded. They can be analog, or AES/EBU, or LAN audio (RAVENNA or AES67 or Livewire). Each source can be encoded several times at different formats, and streamed to several destinations.

Audio samples decoded by X/LINK are played to the selected audio output. An audio output can be analog, or AES/EBU, or LAN audio (AES67 or RAVENNA or Livewire).

Note that decoded audio samples can also be sent to internal audio busses, and audio busses can also be sources to be encoded. This optional feature is used for transcoding IP audio streams.

4.1.5 Programs

On the encoding section of IQOYA X/LINK, a program is the encoding of one or several audio inputs. A program is then defined by the following parameters:

- the audio mode: mono, stereo, multi-channel.
- the audio inputs that receive the signal to be encoded. The number of inputs is given by the audio mode. Stereo and multi-channel modes refer to consecutive inputs.
- the audio format: algorithm, bitrate, sampling frequency.

On the decoding part of IQOYA X/LINK, a program is the decoding of an audio source to the audio output. A program can be composed of three decoding priorities, with automatic switching from a priority to another in case the audio source is lost. Audio sources of the decoding priorities can be:

- an RTP stream (raw RTP),

- a HTTP stream (Icecast/Shoutcast),
- audio inputs,
- sound files or playlists stored locally.

4.1.6 IP services

IP services are the way programs are streamed over the IP network. An IP service can include one audio program, or several multiplexed audio programs (case of MPEG-TS MPTS encapsulation).

When IQOYA streams, an IP service can be sent to one IP destination (unicast or multicast), or several IP destinations (multi-unicast or multi-multicast). The main parameters that define an IP service are:

- the streaming protocol: RTP, UDP, HTTP
- the encapsulation: raw (no encapsulation), MPEG-TS
- the audio program(s) included in the service: one program in case of raw or MPEG-TS SPTS transport; several programs in case of MPEG-TS MPTS transport
- the FEC scheme (IP data redundancy)
- the destination IP address and port. Several destination IP addresses and ports can be declared (multi-unicast / multi-multicast).

When IQOYA decodes, it listens to IP services and unpacks the IP frames in order to extract and decode the audio contents.

4.1.7 Audio buses

The audio buses serve for transcoding IP audio streams. An audio bus can be selected as the output of one or several output programs. In case several output programs are connected to the same internal bus, the bus mixes the audio from the different programs. Note that an output program can be simultaneously connected to an audio output and an internal bus.

An audio bus can also be selected as the audio source of an input program (like an audio input), so that it can be streamed as an IP Service.

4.2 Working principles in “Remote Broadcasting” mode of use

4.2.1 IQOYA X/LINK-ST & X/LINK-LE

IQOYA X/LINK-ST and IQOYA X/LINK-LE can run one stereo IP codec instance or two mono IP codec instances. Each instance of an IP codec allows to receive, establish or terminate one Symmetric RTP or SIP IP audio connection. Before establishing a connection, the user chooses the recipient in the address book or enter the recipient address manually and choose the call profile in the call profile list.

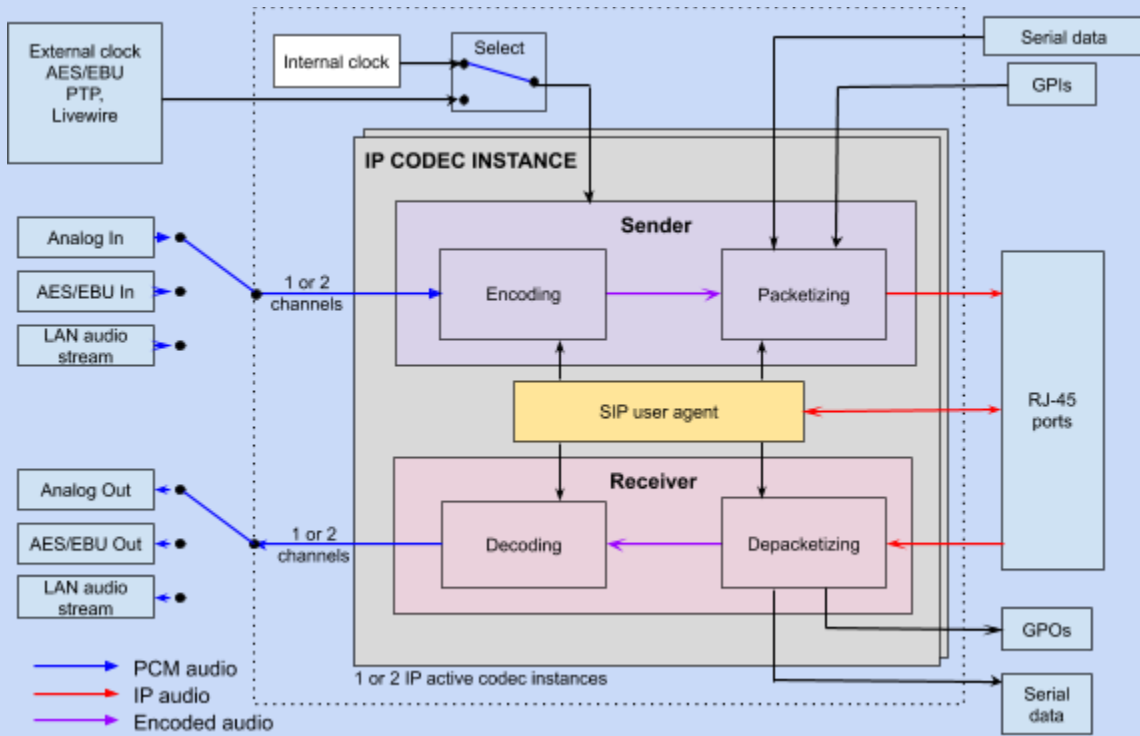

Schematic diagram of IQOYA X/LINK-ST & X/LINK-LE

4.2.2 IQOYA X/LINK-DUAL

IQOYA X/LINK-DUAL can run two stereo IP codec instances or one stereo and two mono IP codec instances or four mono IP codec instances. Each instance of an IP codec allows to receive, establish or terminate one Symmetric RTP or SIP IP audio connection. Before establishing a connection, the user chooses the recipient in the address book or enter the recipient address manually and choose the call profile in the call profile list.

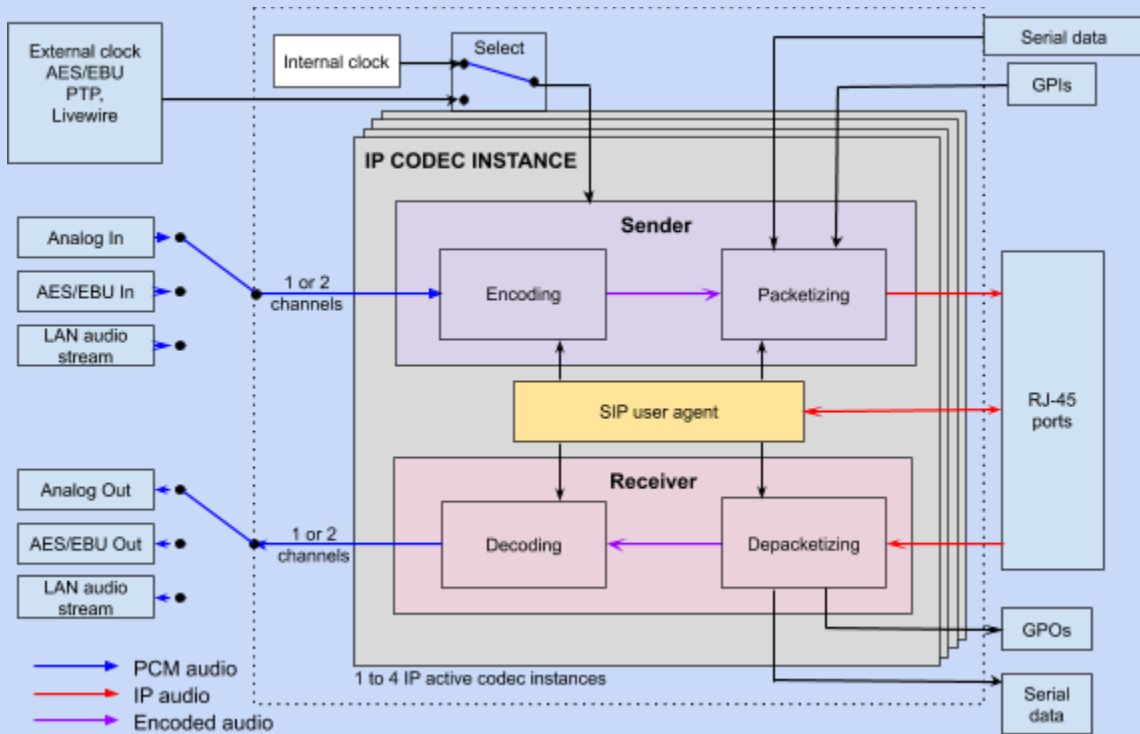

Schematic diagram of IQOYA X/LINK-DUAL

4.2.3 IQOYA X/LINK-AES67

IQOYA X/LINK-AES67 can run 8 stereo IP codec instances or 16 mono IP codec instances or any combination of mono and stereo IP codec instances which total number of audio channels is less than 16. Each instance of an IP codec allows to receive, establish or terminate one Symmetric RTP or SIP IP audio connection. Before establishing a connection, the user chooses the recipient in the address book or enter the recipient address manually and choose the call profile in the call profile list.

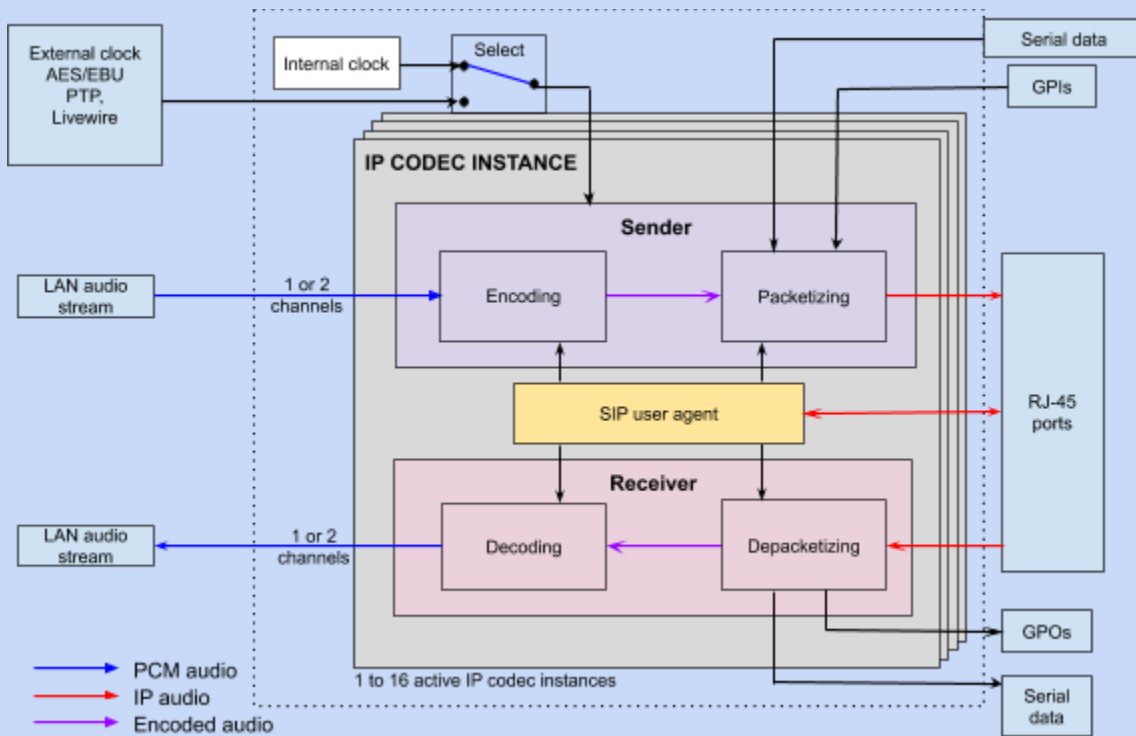

Schematic diagram of IQOYA X/LINK-AES67

4.2.4 Audio inputs and outputs

The audio inputs receive the audio signals to be encoded by the IP codec instance(s). They can be analog, or AES/EBU, or LAN audio (AES67 or RAVENNA or Livewire).

Audio samples decoded by the IP codec instance(s) are played to the audio outputs. An audio output can be analog, or AES/EBU, or LAN audio (AES67 or RAVENNA or Livewire).

4.2.5 IP codec instances

A codec instance can establish a connection with a remote IP codec, accept or refuse a connection request from a remote IP codec, or terminate an established connection. The connections can be SIP, direct SIP or symmetrical RTP.

A stereo (resp. mono) codec instance is associated with a stereo (resp. mono) audio input and a stereo (resp. mono) audio output by configuration. Once a connection has been established, the IP codec instance encodes, packetizes and sends over IP to the remote IP codec the audio samples received from the audio input and, at the same time, it depacketizes and decodes the IP audio stream received from the remote IP codec then push the audio samples to the audio output.

4.2.6 Contacts and Address book

A contact is a SIP address (for SIP connections) and/or an IP address (for Symmetrical RTP connections) that has been named. The address book is the list of all the contacts defined on the equipment. Usually the address book of the studio codecs are populated with the addresses of the field codecs and vice versa.

4.2.6 Call profiles and Call profile list

A call profile is a named set of audio and network parameters used to define the characteristics of a connection and applied at connection establishment. The call profile list is the list of all the call profiles defined on the equipment. The parameters of a call profile are:

- The audio encoding format of the sent stream
- The payload type of the outgoing audio stream
- The packet size of the outgoing audio stream
- The FEC (Forward Error Correction) scheme or dual streaming scheme of the outgoing audio stream
- The outgoing stream QoS (Quality of Service)
- The size of the jitter buffer recommended by the caller to the callee
- The jitter buffer size of the caller
- The audio encoding format expected for the stream sent by the remote
- The payload type expected for the stream sent by the remote
- The FEC (Forward Error Correction) scheme or dual streaming scheme expected for the stream sent by the remote

5 INSTALLATION

5.1 Grounding the IQOYA X/LINK

Attach a ground wire to the chassis (ideally the ground wire has a ring terminal).

Connect the other end of the ground wire to a good electrical ground point.

Once IQOYA is installed and properly grounded, you can connect the Eth ports and audio I/Os as required for your installation.

5.2 Connecting IQOYA X/LINK to the network

We recommend that the first connection to the IQOYA codec is done on a LAN. The default IP addresses of IQOYA X/LINK Eth ports are:

- Eth1: 192.168.0.100
- Eth2: 192.168.1.100
- Eth3: 192.168.2.100
- Eth4: 192.168.3.100

In case you do not know the IP addresses of the IQOYA X/LINK unit you want to connect to, you can read its IP addresses from the front panel (see paragraph “LCD display and keypad”), except for IQOYA X/LINK-LE where the IP addresses are written on the inserted SDHC card at startup (the SD card is not delivered by Digigram).

Make sure all other devices connected to this LAN are in the same subnet and have different IP addresses (this includes the PC from which you will connect to the IQOYA codec to configure).

WARNING:

- Eth1, Eth2, Eth3 and Eth4 must belong to different subnetworks.
- Eth1, Eth3 and Eth4 are Gbits interfaces.
- Eth2 is a 100 Mbits/s interface. **It is recommended to use one of the other interfaces for LAN audio connectivity (AES67, RAVENNA, Livewire).**

5.3 Enabling / disabling the hardware bypass function

IQOYA X/LINK, X/LINK-LE and X/LINK-DUAL allow for the hardware bypass of audio inputs to audio outputs in case of power supply failure. This concerns analog inputs & outputs 1&2, and AES/EBU input & output 1.

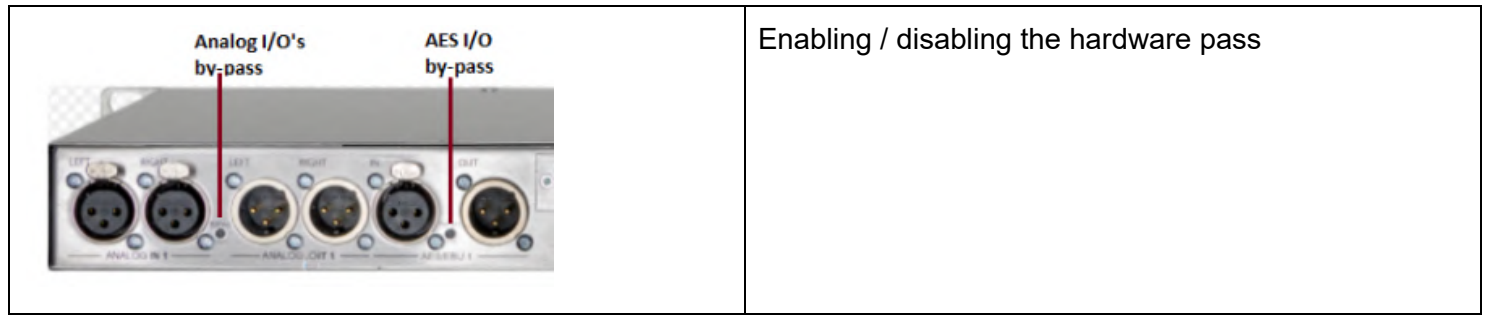

5.4 Powering up IQOYA X/LINK

It is recommended to establish all connections before powering up the device.

IQOYA X/LINK features two internal hot swappable redundant power supply units. It is recommended to connect the two power cords. However, only one cord may be used.

IQOYA X/LINK starts as soon as it is connected to the mains.

5.5 Steps to follow to configure IQOYA X/LINK in “Program Distribution” mode of use

Set the global parameters of your IQOYA X/LINK

If IQOYA is used for encoding:

- Adjust the parameters of the audio inputs: type (analog, AES3, AES67, RAVENNA, Livewire), and gain.
- Declare the programs (encodings)
- Declare the IP services to be streamed over IP (IP audio streams)

If IQOYA is used for decoding:

- Adjust the parameters of the audio outputs: type (analog, AES3, AES67, RAVENNA, Livewire), and gain.

- Declare the IP services to be received from the network (IP audio stream)
- Declare the output program(s)
- Check the status and metrics on the output programs.

If IQOYA is used for transcoding:

- Declare the IP services to be received from the network
- Declare the programs to be decoded from the received IP services, and assign them to internal audio buses.
- Declare the input programs (select audio buses as the sources of these input programs)
- Declare the IP services to be streamed over IP
- Check the status and metrics on the output programs.

5.6 Steps to follow to configure IQOYA X/LINK in “Remote Broadcasting” mode of use

- Set the network parameters of your IQOYA X/LINK
- Adjust the parameters of the audio inputs: name, type (analog, AES3, AES67, RAVENNA, Livewire), and gain.
- Adjust the parameters of the audio outputs: name, type (analog, AES3, AES67, RAVENNA, Livewire), and gain.
- Declare the SIP accounts
- Declare the IP codec instances

6 Accessing IQOYA X/LINK WEB pages

From a WEB browser, connect to the IQOYA X/LINK WEB pages:

- for a network connection through Eth1 port, enter `https://192.168.0.100` (this is the default IP address of Eth1).
- for a network connection through Eth2 port, enter `https://192.168.1.100` (this is the default IP address of Eth2).
- for a network connection through Eth3 port, enter `https://192.168.2.100` (this is the default IP address of Eth3).
- for a network connection through Eth4 port, enter `https://192.168.3.100` (this is the default IP address of Eth4).

The WEB browser displays a message about security certificate. Select the option that allows to continue with this WEB server.

Enter the requested username and password. The default administrator login is:

username = iqoya

password = iqoya

IQOYA X/LINK supports three categories of users: Administrator, User, Read only

- **“Administrator” category**

A user from the “Administrator” category has all the access rights on the WEB pages.

The login to the embedded WEB server as “Administrator” is:

- username: iqoya

- default password: iqoya

Username and password can only be modified when logged as Administrator. See [Preferences -> System -> Password](#).

- **“User” category**

A user from the “User” category has limited access rights. “Write” access is limited to the audio parameters (audio format, source/target IP address and UDP port).

The login to the embedded WEB server as “User” is:

- username: user

- default password: user

Username and password can only be modified when logged as Administrator. See [Preferences -> System -> Password](#).

- **“Read-only” category**

A user from the Read-only category only has “Read” access rights. He cannot modify a single parameter of the codec.

The login to the embedded WEB server as “Read-only” is:

- username: guest

- default password: guest

Username and password can only be modified when logged as Administrator. See [Preferences -> System -> Password](#).

Once the login has passed:

- In “Program Distribution” mode of use the “Properties” WEB page is displayed. This is the home page.

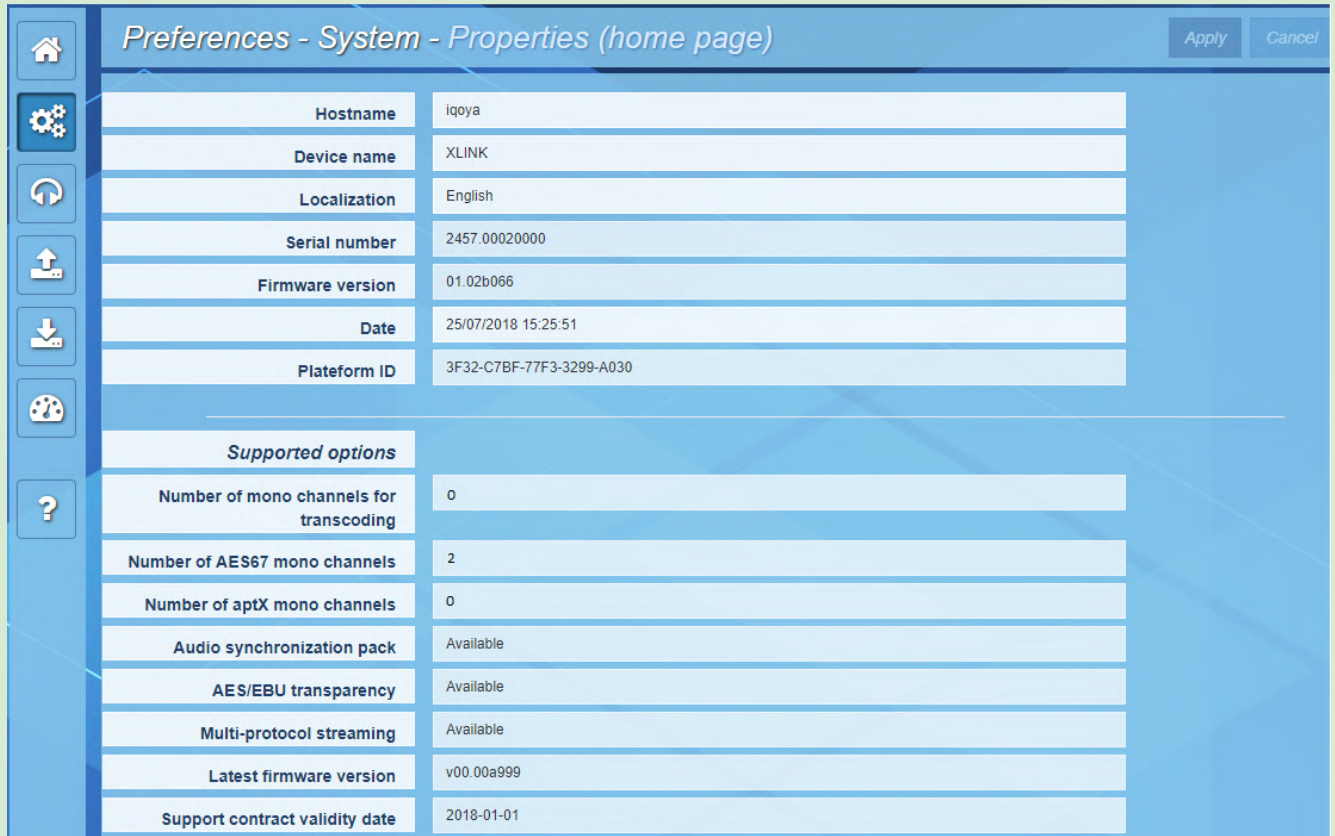

Preferences - System - Properties (home page) Apply Cancel

Hostname	iqoya
Device name	XLINK
Localization	English
Serial number	2457.00020000
Firmware version	01.02b066
Date	25/07/2018 15:25:51
Platform ID	3F32-C7BF-77F3-3299-A030

Supported options

Number of mono channels for transcoding	0
Number of AES67 mono channels	2
Number of aptX mono channels	0
Audio synchronization pack	Available
AES/EBU transparency	Available
Multi-protocol streaming	Available
Latest firmware version	v00.00a999
Support contract validity date	2018-01-01

- In “Remote Broadcasting” mode of use the “Operations” WEB page is displayed. This is the home page.

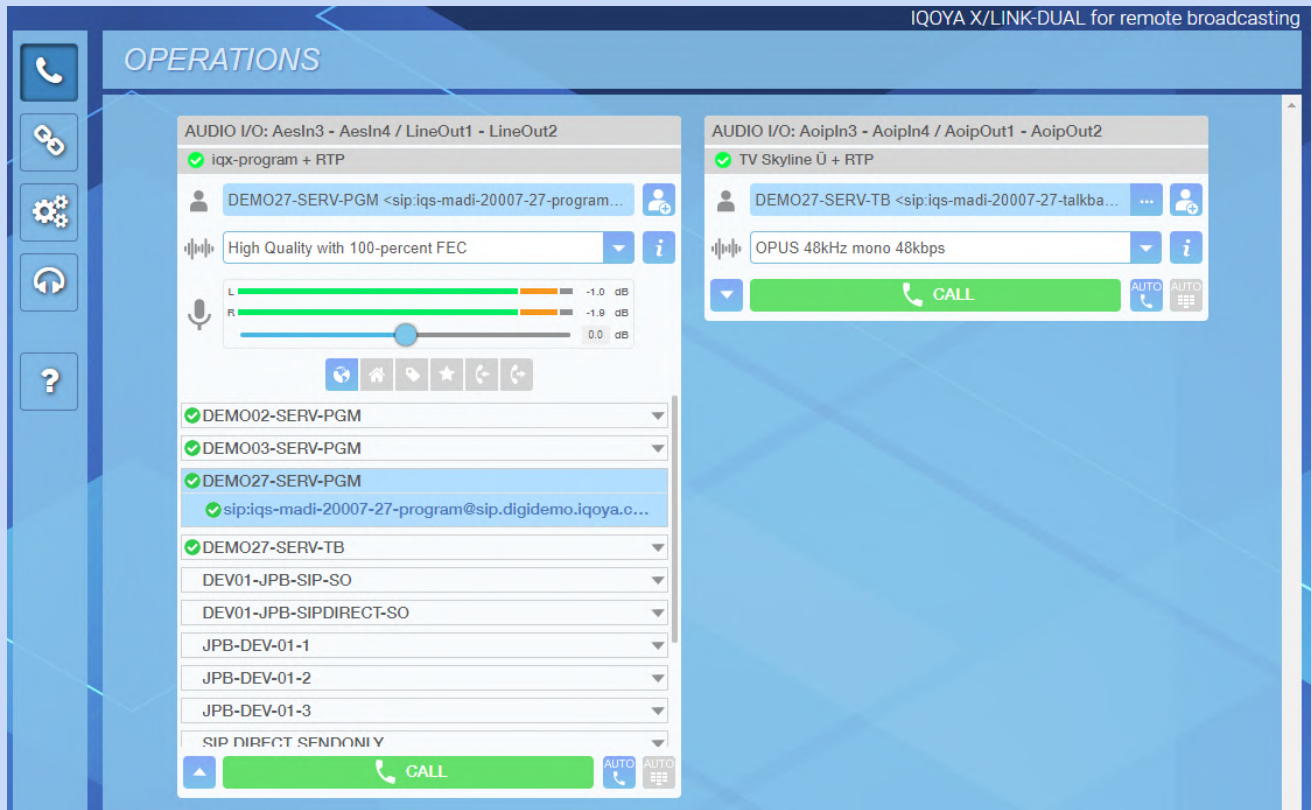

7 Configuration from the WEB pages







Click on the “value” field of a parameter to enter the edit mode. The background colour of all the parameters that can be modified becomes white.

Select/Enter the appropriate values for the parameters of the page, and click on “Apply” on the top right of the page to confirm the settings, or “Cancel to ignore the changes.

8 WEB pages organization

8.1 WEB pages organization in “Program Distribution” mode of use

The WEB pages are organized in categories which are always accessible from the left side of the WEB pages.

Icon	Category	Description
	Home page	Displays the properties of the unit as well as its software options
	Preferences	Global parameters of the unit.
	Audio I/Os	Audio inputs and outputs parameter settings: name, type selection, audio level adjustment, vu-meters
	Encoders	Settings of programs (encodings of audio inputs) and IP services (streaming of programs).
	Decoders	Settings of IP services to be received, and associated audio programs to be decoded to the outputs.
	Status	Display the status of all the encoders and decoders, as well as the alarms.
	Help	About IQOYA X/LINK and this user manual.

8.1.1 “Preferences” category of menus



Click on  to display all the available menus. Move the mouse pointer above the menus to display the submenus. Click on a sub-menu to display the corresponding page.

8.1.1.1 Preferences -> System

8.1.1.1.1 Preferences -> System -> Properties

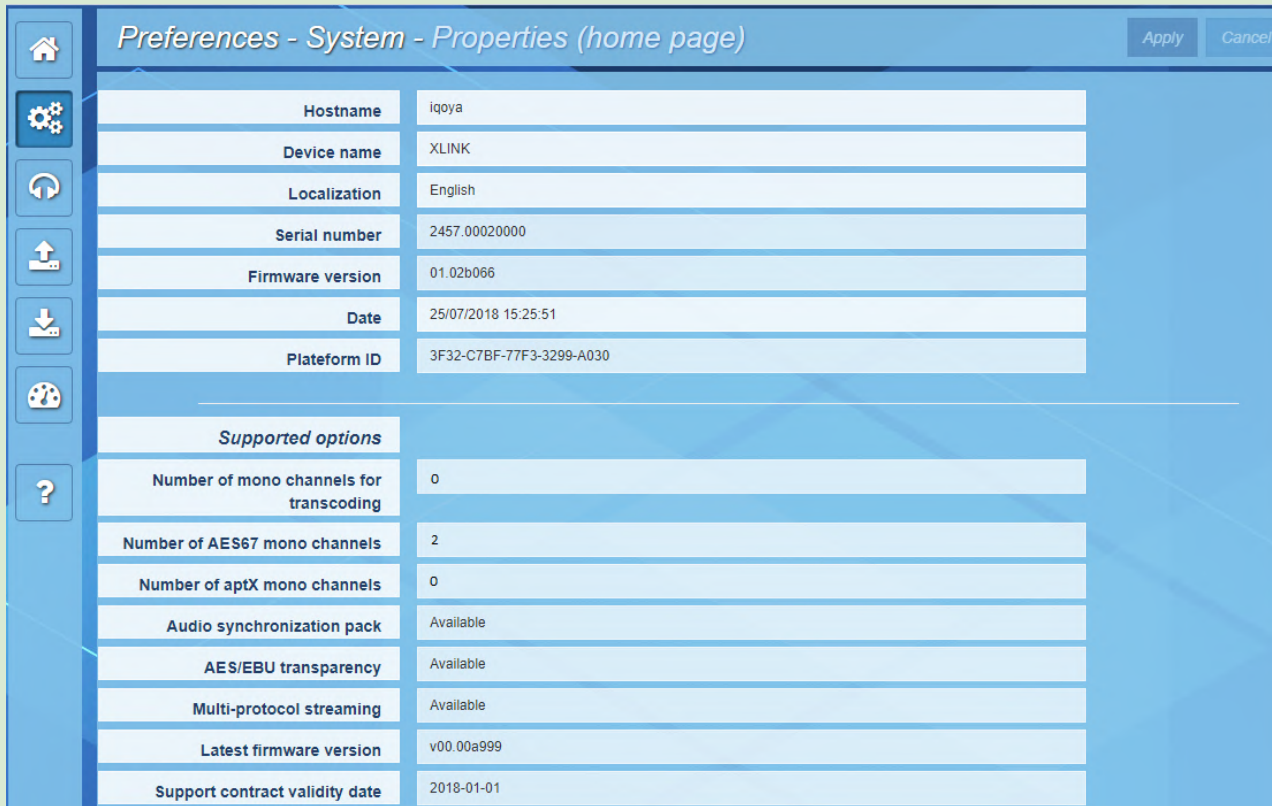

Supported options	
Number of mono channels for transcoding	0
Number of AES67 mono channels	2
Number of aptX mono channels	0
Audio synchronization pack	Available
AES/EBU transparency	Available
Multi-protocol streaming	Available
Latest firmware version	v00.00a999
Support contract validity date	2018-01-01

Parameter	Read/Write	Meaning
Hostname	R / W	Logical name given to the device on the network.
Device Name	R / W	Name given to the equipment
Localization	R / W	Language
Serial number	R	Serial number of the unit. This number is set in factory and cannot be changed.
Firmware version	R	Version of the firmware running on the unit. The firmware can be update.
Date	R / W	Date and time of the unit.
Platform ID	R	Identifier of the unit. this number is required for applying firmware options.
Supported Options		
Number of mono channels for transcoding	R	Number of mono channels supported for transcoding through internal buses.

Number of AES67 mono channels	R	Number of mono input and output channels on AES67 or Ravenna, or Livewire
Number of aptX mono channels	R	Number of mono channels to be processed in aptX
Audio synchronous pack	R	Value 1: the codec features the audio synchronization via NTP Value 0 : the option is not installed.
AES/EBU transparency	R	Value 1: the codec allows for AES transparency transport. Value 0; the option is not installed.
Multiprotocol streaming	R	Value 1: the codec features the multiprotocol streaming. Value 0: the option is not installed
Latest firmware version	R	Maximum firmware version number authorized by the ongoing support contract.
Support contract validity date	R	Defines the date until when the firmware can be updated/upgraded according to the purchased support contract.

8.1.1.1.2 Preferences -> System -> Audio Clock

This page allows defining the X/LINK sampling clock source .

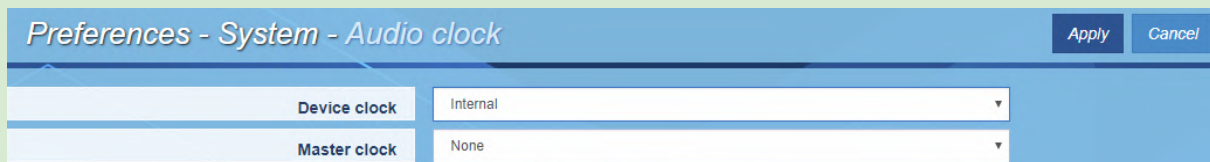

Device clock

The clock source can be:

- Internal: on-board clock
- Extracted from an AES/EBU input (not available on X/LINK-AES67)
- A PTP clock (AES67, RAVENNA)
- A Livewire clock

The clock sampling frequency value is set from Preferences->Audio setup.

Master clock

Allows defining if the codec generates a PTP clock.

8.1.1.1.2.1 PTP clock source

The following parameters appear when the mode “PTP AES67 Slave” is selected:

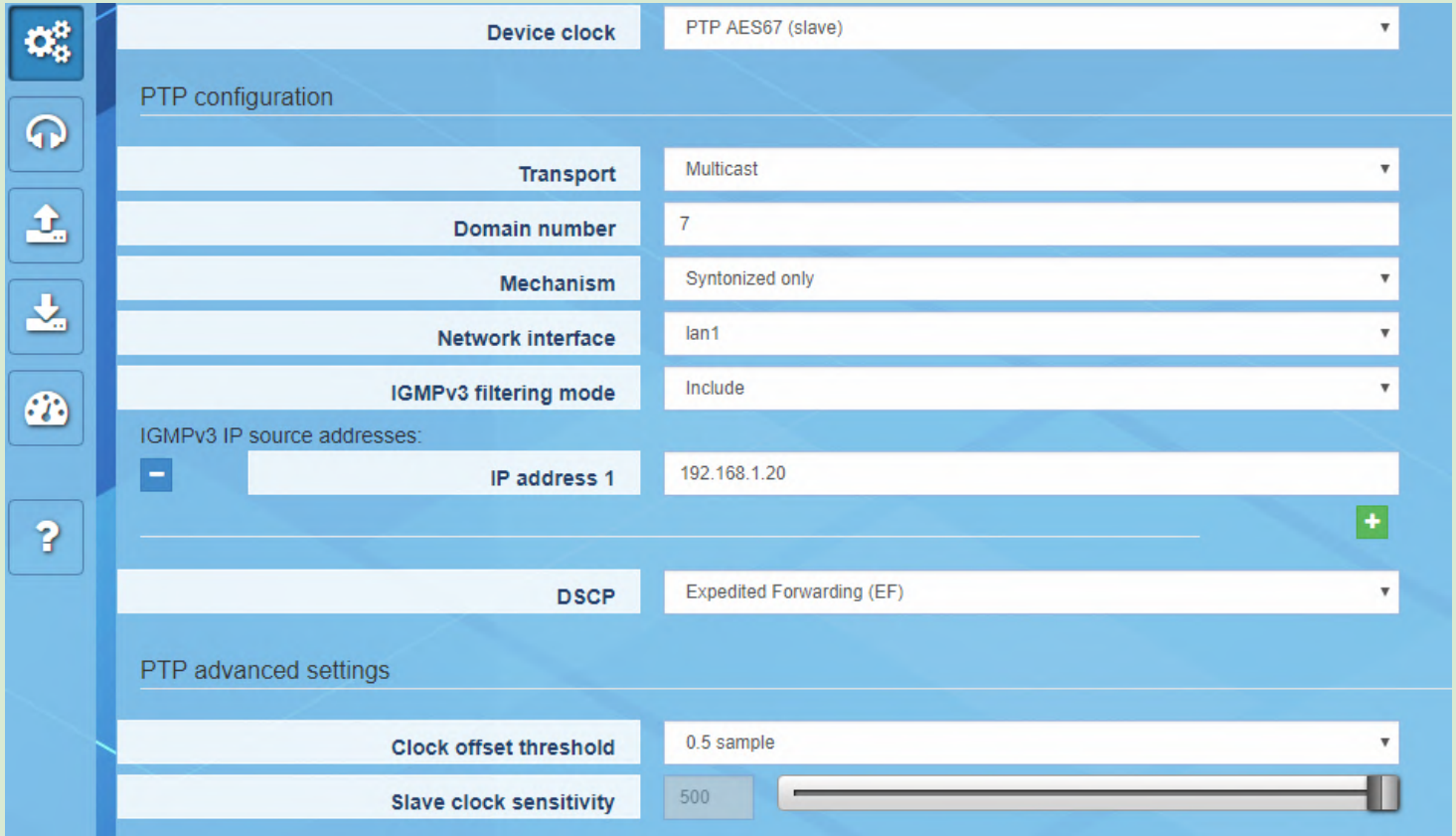

The screenshot shows a configuration page for PTP. On the left is a sidebar with icons for settings, help, and other functions. The main area is titled 'PTP configuration' and contains several settings:

- Device clock:** PTP AES67 (slave)
- Transport:** Multicast
- Domain number:** 7
- Mechanism:** Syntonized only
- Network interface:** lan1
- IGMPv3 filtering mode:** Include
- IGMPv3 IP source addresses:** A table with one entry: IP address 1: 192.168.1.20
- DSCP:** Expedited Forwarding (EF)
- PTP advanced settings:**
 - Clock offset threshold:** 0.5 sample
 - Slave clock sensitivity:** 500 (with a slider)

Transport	R/W	Allows specifying if the PTP clock is unicast or multicast.
Domain number	R/W	PTP clock domain number (from 0 to 128)
Mechanism	R/W	Syntonized: means that IQOYA’s clock is the same as the Grandmaster PTP, but they are not synchronous (delay between the two clocks). Synchronous clock is obtained thanks to E2E or P2P modes, which serve to compensate the delay between Grandmaster PTP clock and IQOYA. E2E is a more universal setting (it consists of requests and answers between the node (IQOYA) and the Grandmaster PTP clock unit). P2P provides higher clock sync precision but requires full PTP support from all participating switches (between IQOYA and related clock master.) In case the PTP clock is generated by an IQOYA, the PTP mechanism must be the same as in the IQOYA master: syntonized.
Network interface	R/W	Select the network interface that receives the PTP

IGMPv3 filtering mode	R/W	<p>Off: X/LINK subscribes to the multicast PTP clock which can be generated by any source IP address.</p> <p>Include: X/LINK subscribes to the multicast PTP clock which is generated only by the listed source IP addresses.</p> <p>Exclude: X/LINK subscribes to the multicast PTP clock which is generated by any source IP address, with exception of the listed IP addresses..</p>
IGMPv3 IP source addresses		
IP address x	R/W	<p>Allows declaring the source IP addresses to be included or excluded. Click on  to add an IP@ to the list.</p>
DSCP	R/W	<p>QoS assigned to the PTP frames. Select the value from the drop down list. For optimal QoS on PTP, "Expedited forwarding (EF)" value is recommended.</p>
PTP advanced settings		
Clock offset threshold	R/W	<p>This parameter defines the condition for being synchronized to the PTP clock. The lower the value, the better the phase with the PTP clock. Lower values require a deterministic network. For networks that introduce an erratic jitter to the PTP frames, the value must be increased.</p> <p>Default value is 0.5 sample. It can be increased up to 64 samples.</p>
Slave clock sensitivity	R/W	<p>It defines the sensibility of the slave clock to the PTP packet jitter. Enter a value between 500 (for a high sensitivity) and 100 (for a low sensitivity). Default value is 500</p>

The *clock offset distribution* section displays information about the received PTP clock.

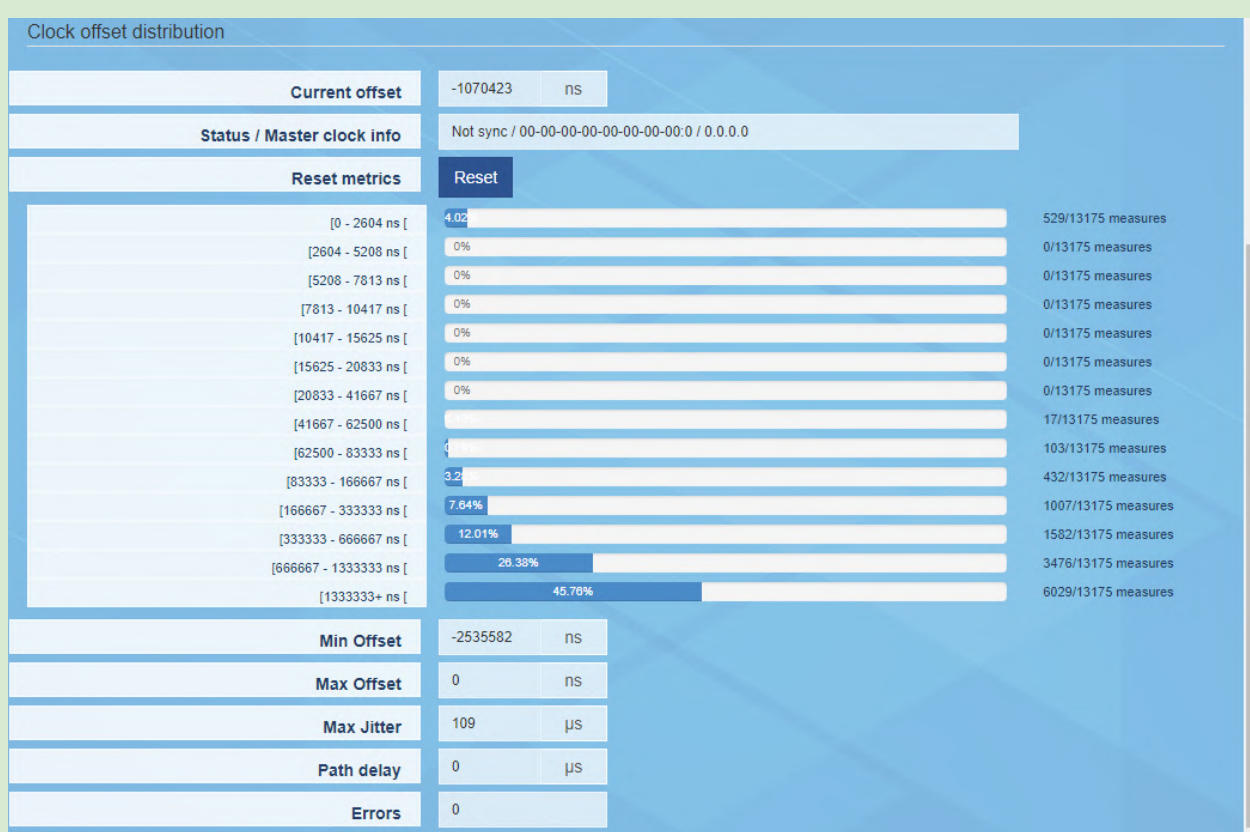

8.1.1.1.2.2 Livewire (Slave)

The following parameters appear when the mode “Livewire Slave” is selected:



Device clock: Livewire (slave)

Network interface: lan4

IGMPv3 filtering mode: Off

Network interface	R/W	Select the network interface that receives the livewire clock.
IGMPv3 filtering mode	R/W	Off: X/LINK subscribes to the Livewire clock which can be generated by any source IP address. Include: X/LINK subscribes to the Livewire clock which is generated only by the listed source IP addresses. Exclude: X/LINK subscribes to the Livewire clock which is generated by any source IP address, with exception of the listed IP addresses..

IGMPv3 IP source addresses		
IP address x	R/W	Displayed if IGMPv3 filtering mode is set to “Exclude” or “Include”. Allows declaring the source IP addresses to be included or excluded. Click on  to add an IP@ to the list.

The *clock offset distribution* section displays information about the received Livewire clock.

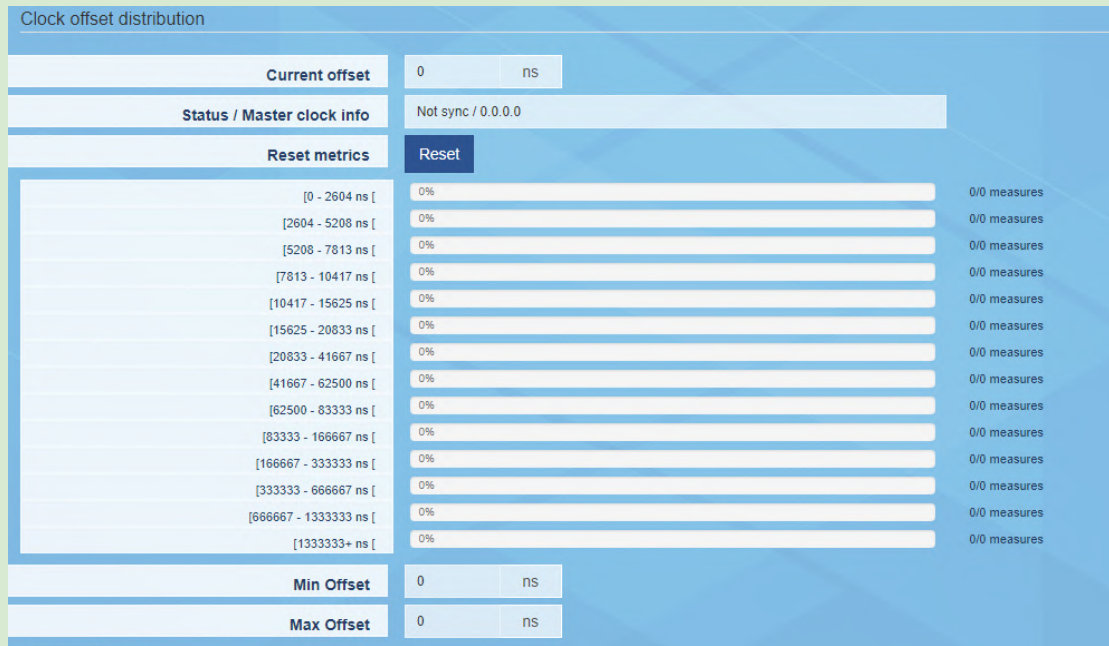

Click on “Apply” to confirm your choice.

8.1.1.1.3 Preferences -> System -> Audio setup

This page allows setting the processing granularity and the working sampling frequency value IQOYA X/LINK



Click on a parameter field to be able to change the values.

Parameter	Description
<i>Processing granularity</i>	This is the smallest amount of data processed at a time by IQOYA. The lower the processing granularity, the lower the latency. Possible values are 1ms, 2ms, 3 ms, 4 ms.

	<p>However, a value of 1ms may lead to audio underruns, depending on the features enabled on IQOYA. In case this happens, it is necessary to increase the processing granularity value. Note: the payload size of an IP frame is adjustable via parameter Payload size, from the Send page (see paragraph Encoder parameters configuration).</p>
Sampling frequency	<p>It defines the working sampling frequency of IQOYA. Note that received and generated IP streams can carry audio at a different sampling frequencies (in which case a high quality frequency change is applied). When sampling frequency is set to 48 kHz, IP streams can be at 48 kHz, 32 kHz, 16 kHz (G722), and 8 kHz (G711). Note that 44.1 kHz is allowed for a HTTP stream. When sampling frequency is set to 44.1 kHz, IP streams must be at 44.1 kHz.</p>

Click on “Apply” to confirm your changes.

8.1.1.1.4 Preferences -> System -> Alarms setup

Each alarm occurring on IQOYA can be written in a log file, or/and sent to a GPO, or/and signalled as an SNMP trap (not available in the first firmware version).

The “Alarms setup” page allows enabling/disabling each alarm notifications

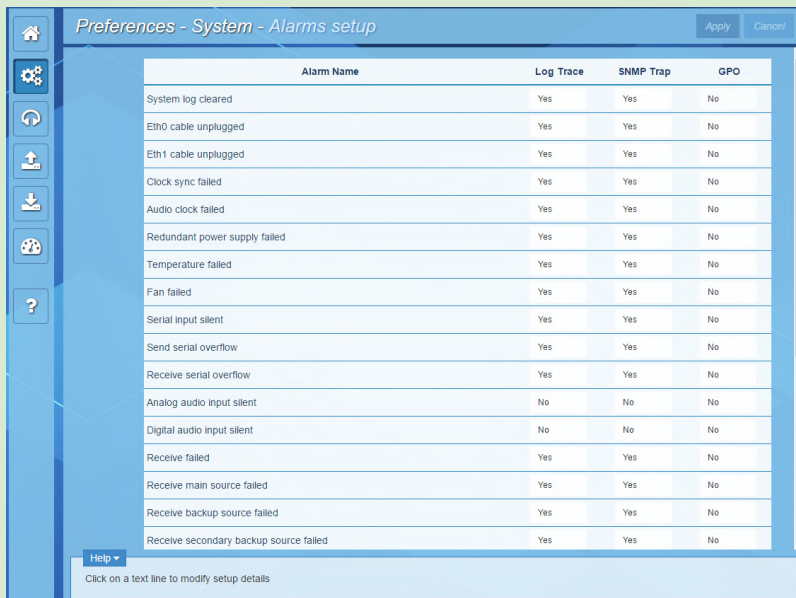

Click on a parameter field to be able to change the values.
 Click on “Apply” to confirm your changes.

Available alarms

System log cleared	Log file has been cleared
Eth0 cable unplugged	No connection of Eth0
Eth1 cable unplugged	No connection of Eth1
Clock sync failed	External synchro failure (PTP, NTP)
Audio clock failed	Audio sampling clock failure
Redundant power supply failed	PSU failure
Temperature failed	Temperature too high
Fan failed	Internal fan failure
Serial input silent	
Send serial overflow	
Receive serial overflow	
Analog audio input silent	Silence detected on the analog input according the criteria of silence
Digital audio input silent	Silence detected on the analog input according the criteria of silence

Receive failed	No available defined IP stream on the output program
Receive main source failed	Priority 1 of the output program is not available
Receive backup source failed	Priority 2 of the output program is not available
Receive secondary backup source failed	Priority 3 of the output program is not available
Receive sync failed	
Receive main source disabled	Priority 1 on the output program is disabled
Receive backup source disabled	Priority 2 on the output program is disabled
Receive secondary backup source disabled	Priority 3 on the output program is disabled
Receive main source primary stream failed	In case of streaming with FEC on priority 1, this means that the primary stream is lost on priority 1
Receive backup source primary stream failed	In case of streaming with FEC on priority 2, this means that the primary stream is lost on priority 2
Receive secondary backup source primary stream failed	In case of streaming with FEC on priority 3, this means that the primary stream is lost.
Receive main source redundancy stream failed	In case of streaming with FEC on priority 1, this means that the FEC is lost.
Receive backup source redundancy stream failed	In case of streaming with FEC on priority 2, this means that the FEC is lost.
Receive silent	Audio in the IP stream is silent according to the silence criteria.

8.1.1.1.5 Preferences -> System -> Logs

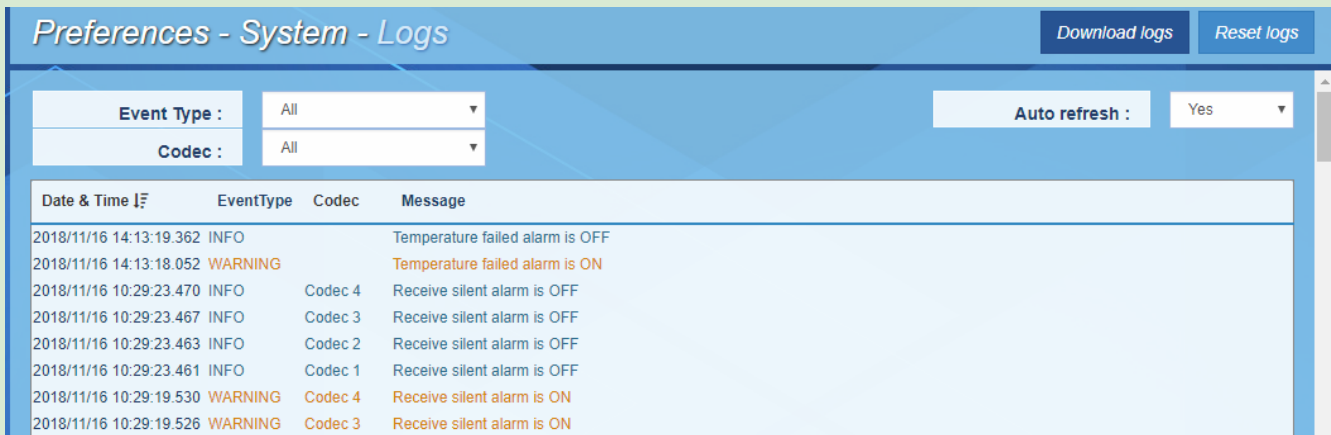

Date & Time	Event Type	Codec	Message
2018/11/16 14:13:19.362	INFO		Temperature failed alarm is OFF
2018/11/16 14:13:18.052	WARNING		Temperature failed alarm is ON
2018/11/16 10:29:23.470	INFO	Codec 4	Receive silent alarm is OFF
2018/11/16 10:29:23.467	INFO	Codec 3	Receive silent alarm is OFF
2018/11/16 10:29:23.463	INFO	Codec 2	Receive silent alarm is OFF
2018/11/16 10:29:23.461	INFO	Codec 1	Receive silent alarm is OFF
2018/11/16 10:29:19.530	WARNING	Codec 4	Receive silent alarm is ON
2018/11/16 10:29:19.526	WARNING	Codec 3	Receive silent alarm is ON

This page allows viewing and downloading the log file of IQOYA X/LINK. This log file gives information about the internal behaviour of IQOYA, and is useful for advanced diagnostics. Traces of enabled alarms are written into this log file (alarm ON, alarm OFF). This log file is stored internally and is persistent to a power cycle, a restart or reboot.

- Event Type:** allows selecting the category of traces to be displayed: Infos, Warnings, Errors, Errors & Warnings.
- Codec:** allows selecting one of the codecs so that only log traces related to this codec are displayed. The number of the codec can be seen from the Send/IP Services page, and from the Receive/ Programs page.
- Auto refresh:** The page content is refreshed automatically if this parameter is set to “Yes”.
- Date & Time:** clicking on this icon allows to sort out the traces by date and time, starting by most recent traces or starting by oldest traces.
- Reset logs:** resets all the traces.
- Download logs:** allows remotely downloading the log traces.

8.1.1.1.6 Preferences -> System -> Download / Upload

This page allows downloading the IQOYA configuration to a remote PC, or uploading a configuration from a remote PC to IQOYA.

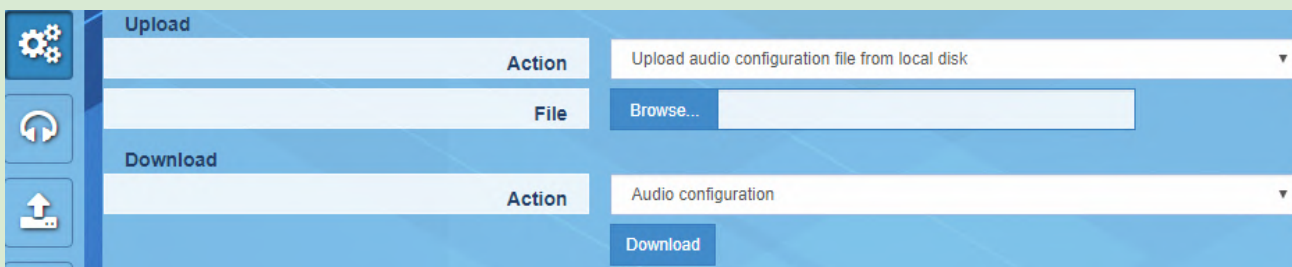

To save the current configuration of IQOYA to a remote PC, click on “Download”.
 To apply a configuration to IQOYA, click on “Browse” to select the configuration file, and click on “Apply”.

The configuration that can be uploaded/downloaded can be:

- The audio configuration only (includes the programs and IP services)
- The full codec configuration

In addition, the html file which allows to view all the parameters of the codec can be downloaded. From the download section, select “ Device Information”, and download.

8.1.1.1.7 Preferences -> System -> SD card

This page allows:

- mounting an SDHC card if it is inserted while the unit is running,
- unmounting it before removing it from the front panel.
- Viewing the SDHC card status: mounted/unmounted

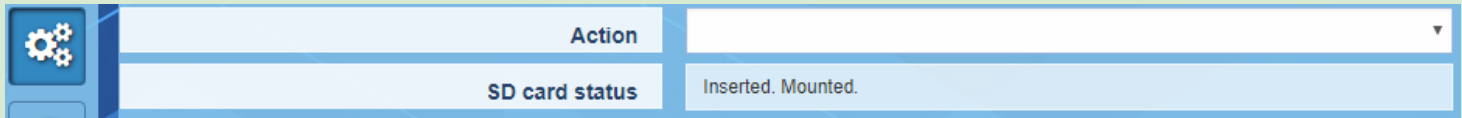

8.1.1.1.8 Preferences -> System -> SD card backup

The codec configuration can be saved to SDHC card or loaded from it.

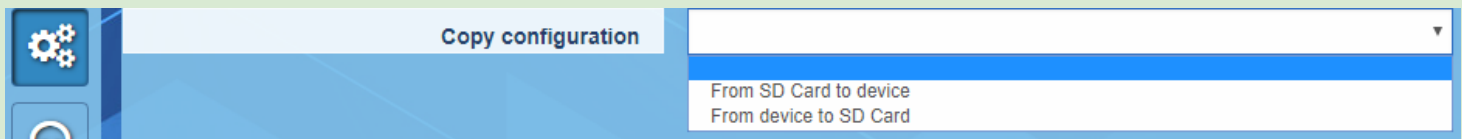

- From the “Copy configuration” field, select whether the configuration has to be copied from the SDHC card to IQOYA’s internal memory or from the internal memory to the SDHC card.

Notes:

- Audio activity is stopped when the configuration is loaded from the SDHC card.
- The unit is restarted to apply the new configuration.
- On the SDHC card, the configuration file “IQOYA_Configuration_save.tar” is stored in folder \IQOYA_LINK\Config.
- The current configuration of the IQOYA codec can also be displayed from a WEB browser by selecting the file \IQOYA_LINK\ Config.html, accessible via FTP.
- The configuration saved on the SDHC card can be loaded from the IQOYA X/LINK front panel LCD display and keyboard (menu System)
- This configuration on SDHC card can also be loaded when starting IQOYA with the SD card inserted. The file “/SDCARD/iqoya_link/run_once/ boot_commands.txt” must contain the following line: `RESTORE_FULLCONFIG_FROMSD=Yes`

8.1.1.1.9 Preferences -> System -> Firmware update

IQOYA can be updated with a new firmware, a patch, or an optional license. The first phase of the update consists in uploading and checking the software package; during this phase, the audio activity is not stopped. The second phase consists in applying the uploaded package; audio activity is stopped during this phase. Two firmware versions are stored locally: the currently running version, and the previous version. This allows to go back to the previous firmware version if an issue is experienced with the more recent version, without having to go through an upload.

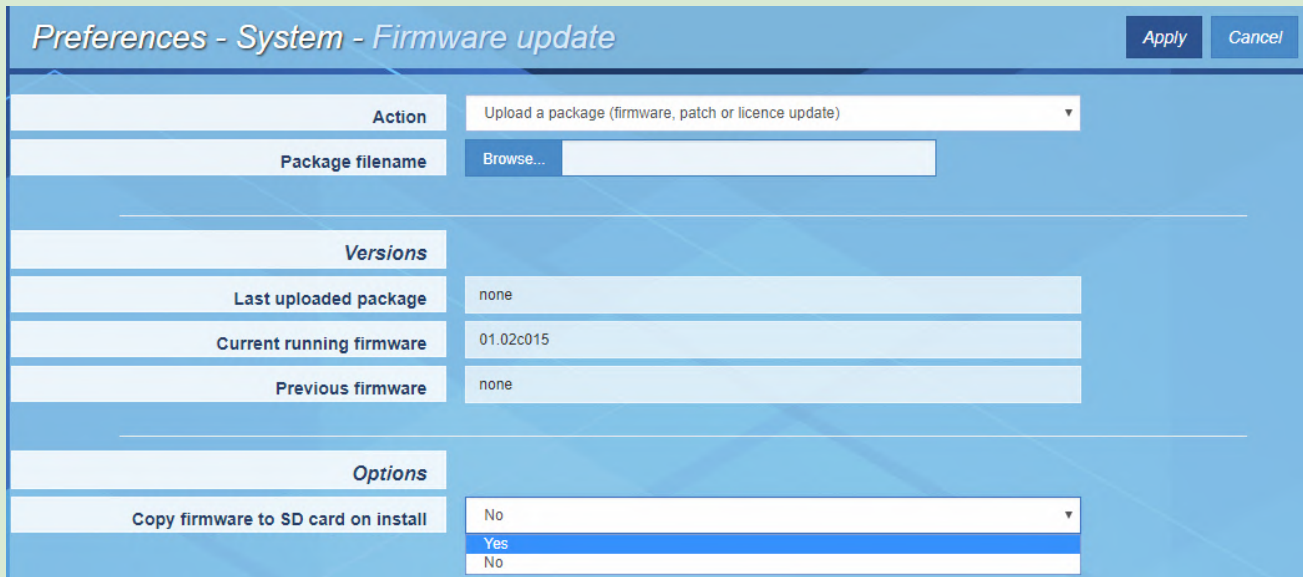

Preferences - System - Firmware update Apply Cancel

Action Upload a package (firmware, patch or licence update) ▼

Package filename Browse...

Versions

Last uploaded package none

Current running firmware 01.02c015

Previous firmware none

Options

Copy firmware to SD card on install No ▼
Yes
No

Click on the “Action” field, and click on the arrow to display the list of possible actions.

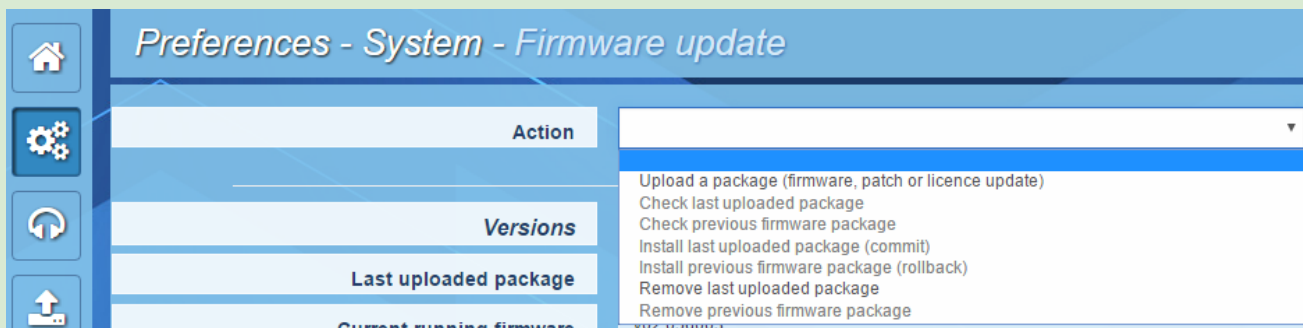

Preferences - System - Firmware update

Action ▼

- Upload a package (firmware, patch or licence update)
- Check last uploaded package
- Check previous firmware package
- Install last uploaded package (commit)
- Install previous firmware package (rollback)
- Remove last uploaded package
- Remove previous firmware package

Select the appropriate action through the list.

For a firmware update, select “Upload a package”, and click on “Browse” to select the file to be uploaded.

Click on “Apply” to start the upload. Audio activity is not stopped during the upload.

Once the package upload is completed, select the action “Install last uploaded firmware”, and click on “Apply”.

Applying the firmware stops the audio activity. The equipment restarts automatically.

The following operations are also possible from the “Action” drop-down menu:

- **Check previous firmware package:** this allows checking that the previous firmware version that is stored locally is correct.
- **Check last uploaded package:** this allows checking that the last uploaded firmware version is correct. This operation is done automatically during the upload phase.
- **Install previous firmware package (rollback):** this allows installing a previous version of the firmware that is stored locally. This is a firmware downgrade.
- **Remove last uploaded package:** this allows deleting the last uploaded package. This means that this package will not be installed.

- **Remove previous uploaded package:** this allows deleting the previous uploaded package. This means that an upload is necessary for a firmware downgrade.

Copy firmware to SD card on install

Set to Yes, this parameter allows copying to the SD card the firmware to be installed to facilitate a future possible firmware rollback. Exemple:

- Firmware to be upload and applied: version A
 - Copy to SD card set to Yes
 - Firmware to upload and applied: version B
 - Copy to SD card set to Yes
- => Current firmware = version B / Previous firmware = version A
 At this point version A can be re-installed without the upload phase.

8.1.1.1.10 Preferences -> System -> Password

This page allows changing the username and password for a given user category. This can be done when logged to the IQOYA as Administrator.

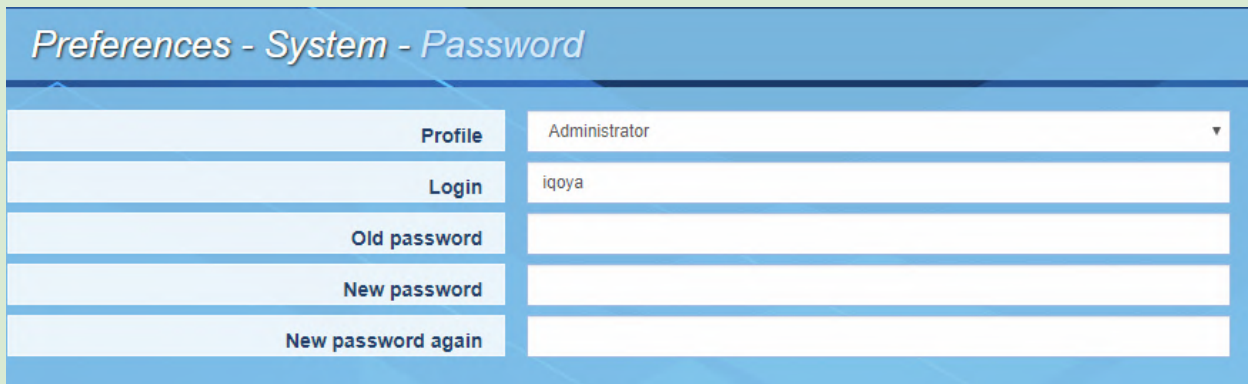

Profile	Administrator
Login	iqoya
Old password	
New password	
New password again	

First select the profile for which credentials have to be changed.

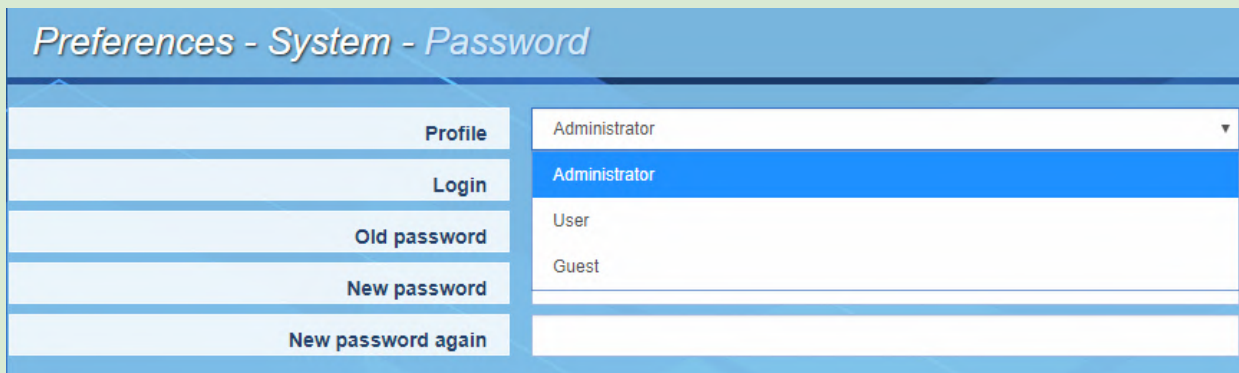

Profile	Administrator
Login	Administrator
Old password	User
New password	Guest
New password again	

Login: allows configuring the username to be used in order to log to the WEB GUI with the selected profile.

Old password: Type the current password

New password: Type the new password

New password again: confirm the new password
Click on “Apply” to confirm the changes.

8.1.1.1.11 Preferences -> System -> Shutdown / Restart
This page allow to restart or shutdown IQOYA.

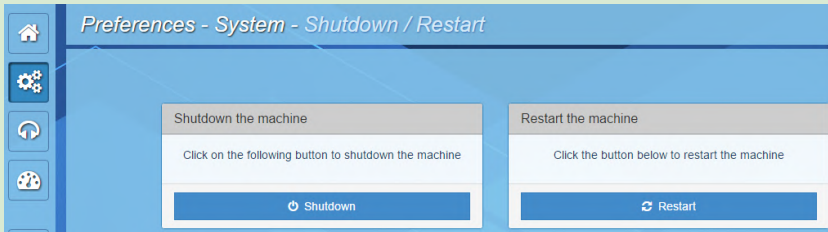

Click on the appropriate action.

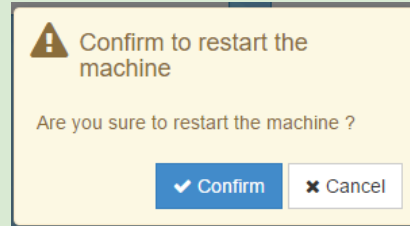

Confirm or cancel your choice through the displayed confirmation window.

8.2.3.1.11 Preferences -> System -> Switch mode of use

This page allows switching from “Program Distribution” mode of use to “Remote Broadcasting” mode of use and vice versa:

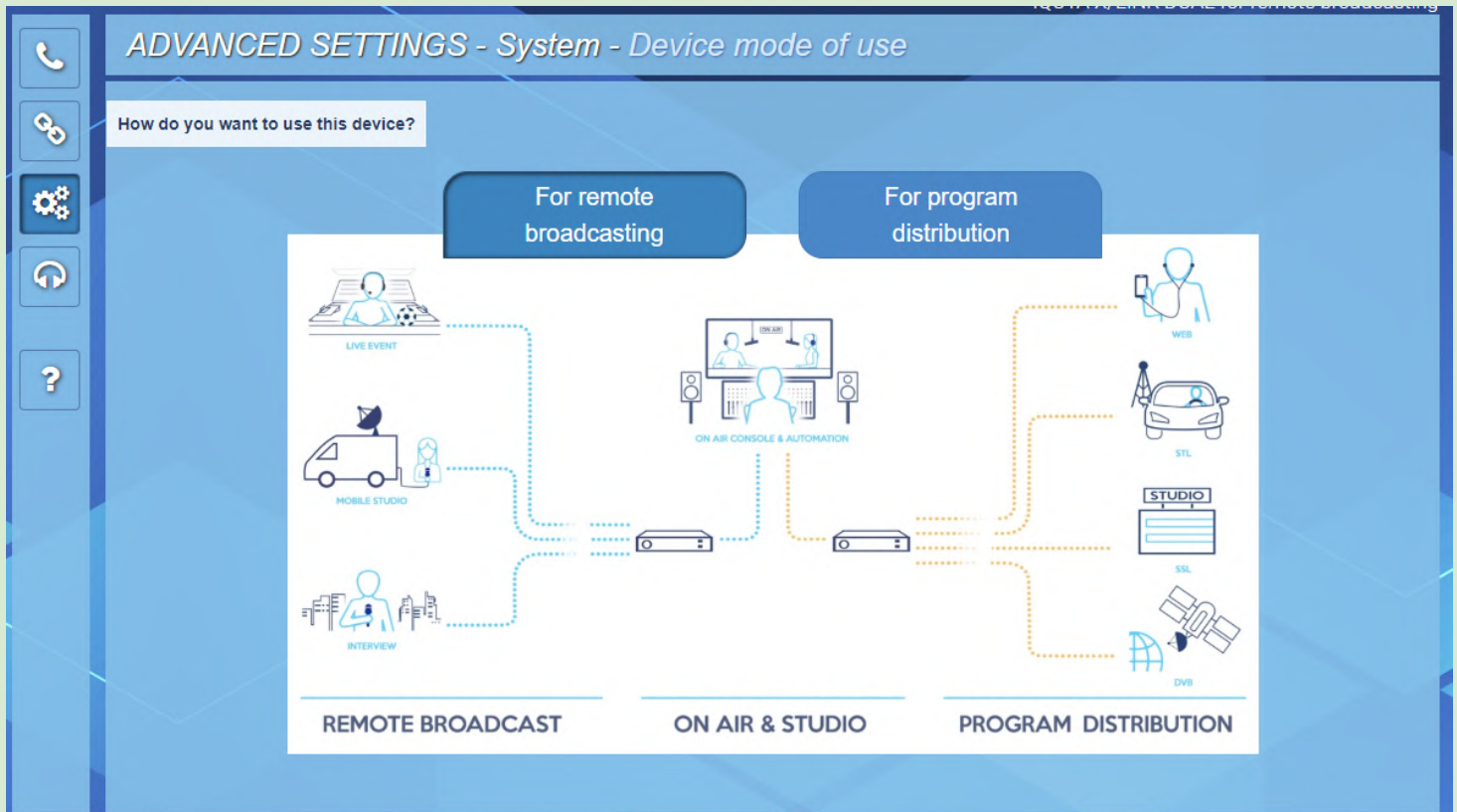

For remote broadcasting

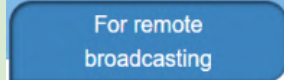
To switch to “Remote Broadcasting” mode of use, click  button then confirm your choice through the displayed confirmation window:

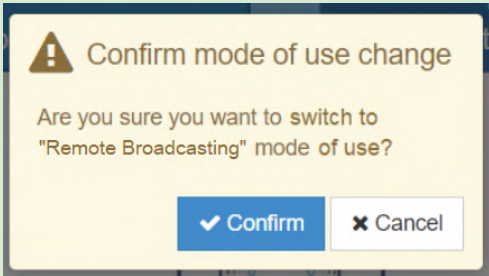

8.1.1.2 Preferences -> Services

This menu allows configuring the “network” services of IQOYA.

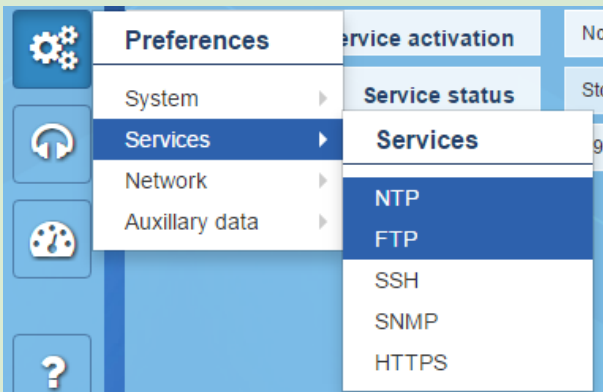

8.1.1.2.1 Preferences -> Services -> NTP

This page allows:

- configuring the date and time synchronization to an NTP server.
- enabling the optional feature “audio synchronization on NTP clock”.

NTP service is disabled by default.



Click on the “**service activation**” field to activate/deactivate the NTP service. Select “Yes” to activate it. Enter then the IP address of the NTP server.

In case you just need to activate the date and time NTP synchronization, click on “Apply”. The status of the service is displayed in the field “Service status”.

For activation of the NTP based audio synchronization, select “Yes” for parameter “**Sync audio on NTP clock**”.

Service activation	Yes		
Service status	Running, synchronized		
Server IP address	fr.pool.ntp.org		
Audio synchronization			
Sync audio on NTP clock	Yes		
Clock offset distribution			
Current offset	0	US	Reset NTP metrics Reset
[0 ; 250 µs[100%		8593/8593 measures
[250 ; 500 µs[0%		0/8593 measures
[500 ; 750 µs[0%		0/8593 measures
[750 ; 1000 µs[0%		0/8593 measures
[1000 ; 2500 µs[0%		0/8593 measures
[2500 ; 5000 µs[0%		0/8593 measures
[5000 ; 7500 µs[0%		0/8593 measures
[7500 ; 10000 µs[0%		0/8593 measures
[10000 ; 15000 µs[0%		0/8593 measures
[15000 ; 20000 µs[0%		0/8593 measures
[20000 ; 50000 µs[0%		0/8593 measures
[50000 ; 75000 µs[0%		0/8593 measures
[75000 ; 100000 µs[0%		0/8593 measures
[100000 ; + µs[0%		0/8593 measures

Once IQOYA is synchronized on the NTP server, the field “Service status” displays “Running, synchronized”. This requires that the software option is installed on the IQOYA X/LINK, as well as on the associated IQOYA decoders.

8.1.1.2.2 Preferences -> Services -> FTP

FTP is useful typically for managing the backup playlists and sound files on IQOYA’s internal storage (uploading/deleting).

FTP service is disabled by default.

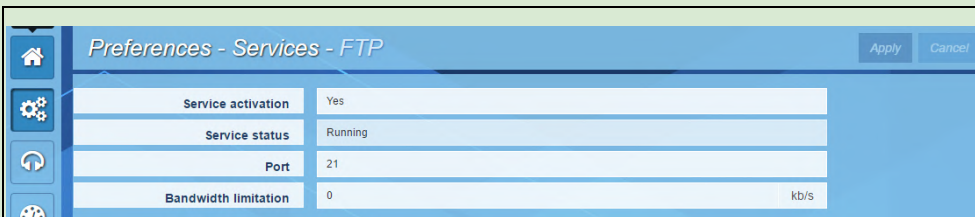

Click on the “Service activation” field. Select “Yes” to enable the FTP service, “No” to disable it. If necessary, you may change the port used for FTP (default value is 21). Parameter “Bandwidth limitation” allows limiting the network bandwidth of the FTP traffic. Click on “Apply” to confirm the

changes.
 Note that a username and password are required to establish an FTP connection to IQOYA X/LINK. Username is: ftp. Password is the administrator password, by default: iqoya.

Note that backup playlists and sound files have to be stored in folder `DEVICE_STORAGE`.

8.1.1.2.3 Preferences -> Services -> SSH

This page allows enabling/disabling the SSH service on IQOYA.

SSH is mainly to be used by Digigram technical support for advanced diagnostics.



The screenshot shows the 'Preferences - Services - SSH' configuration page. It features a sidebar with navigation icons (Home, Settings, Phone, Help) and a main content area with two rows of configuration options:

Service activation	Yes
Service status	Running

Buttons for 'Apply' and 'Cancel' are located in the top right corner.

8.1.1.2.4 Preferences -> Services -> SNMP

This page allows setting the SNMP parameters.

It also displays the System group MIB-II information.

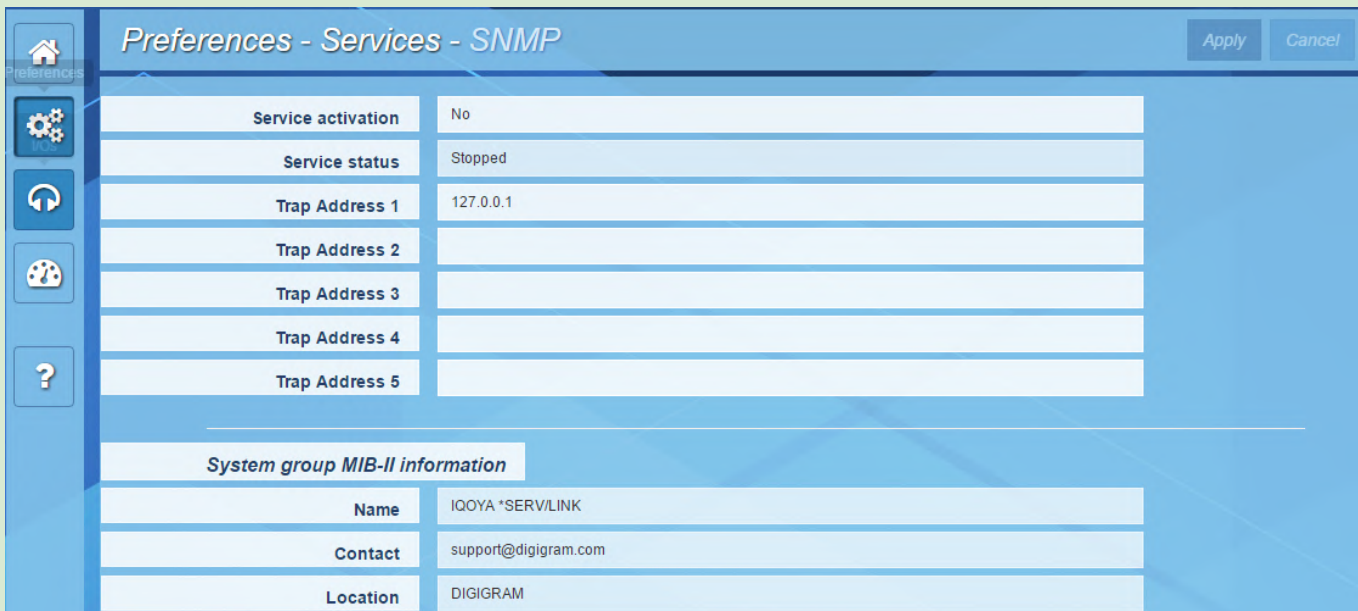

The screenshot shows the 'Preferences - Services - SNMP' configuration page. It features a sidebar with navigation icons (Home, Settings, Phone, Help) and a main content area with two sections:

SNMP Service Configuration:

Service activation	No
Service status	Stopped
Trap Address 1	127.0.0.1
Trap Address 2	
Trap Address 3	
Trap Address 4	
Trap Address 5	

System group MIB-II information:

Name	IQOYA *SERV/LINK
Contact	support@digigram.com
Location	DIGIGRAM

Buttons for 'Apply' and 'Cancel' are located in the top right corner.

IQOYA can be controlled and monitored via SNMP (SET, GET, Traps) provided that the SNMP service is activated.

IQOYA can send the SNMP traps to up to 5 SNMP supervisors (Trap addresses 1 to 5).

Click on "Apply" to confirm the settings.

8.1.1.2.5 Preferences -> Services -> HTTPS

This page allows setting a bandwidth limitation to the HTTP traffic.

In case the IP audio stream takes almost all the available network bandwidth, the HTTP traffic generated when accessing the WEB pages may disturb the IP audio frames transmission, because the total bandwidth necessary for the IP audio stream plus HTTP traffic may exceed the available network bandwidth.

To avoid this problem, IQOYA offers the possibility to set a bandwidth limitation for the HTTPS traffic.

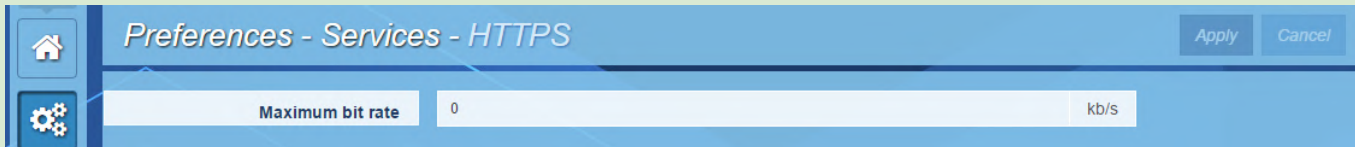

Click on the “Maximum bit rate” field, and enter the maximum bit rate allowed for HTTPS traffic.

Default value is 0, which means no limitation on HTTPS traffic.

The smaller the value, the longer it takes to load the WEB page!

Click on “Apply” to confirm the settings.

8.1.1.2.6 Preferences -> Services -> Publish / Discover

This page allows enabling the automatic discovery and publishing of AES67 or RAVENNA streams.

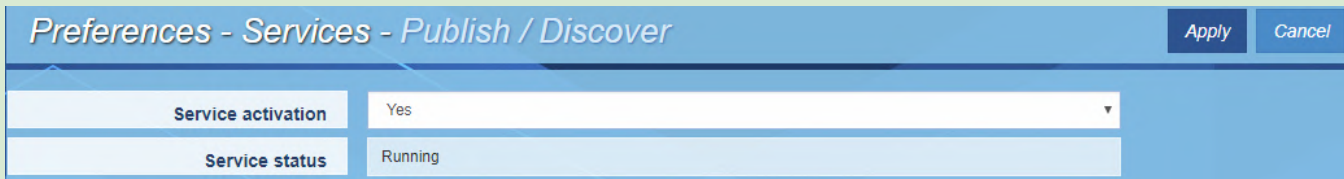

In case you do not use AES67 or RAVENNA audio I/Os, there is no need to activate this service.

8.1.1.3 Preferences -> Network

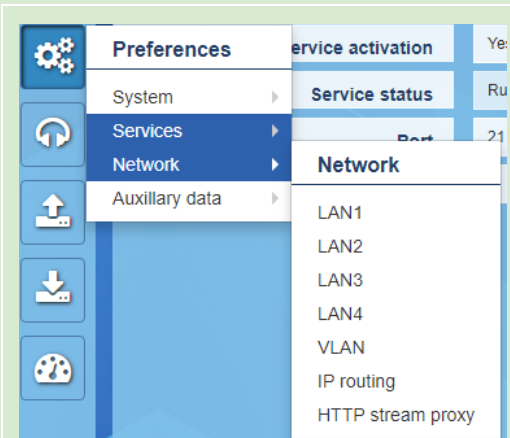

This menu allows accessing the network configuration of IQOYA.

8.1.1.3.1 Preferences -> Network -> LANx

These pages allow configuring the four network ports of IQOYA X/LINK.

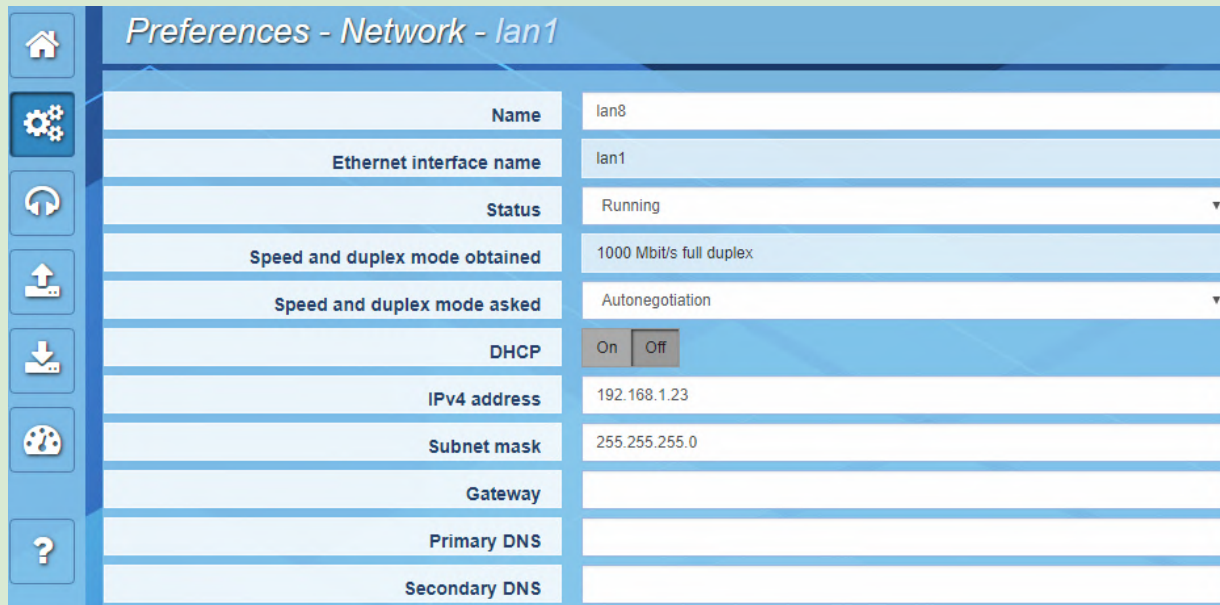

Parameter	Value
Name	lan8
Ethernet interface name	lan1
Status	Running
Speed and duplex mode obtained	1000 Mbit/s full duplex
Speed and duplex mode asked	Autonegotiation
DHCP	On <input type="checkbox"/> Off <input type="checkbox"/>
IPv4 address	192.168.1.23
Subnet mask	255.255.255.0
Gateway	
Primary DNS	
Secondary DNS	

Click on a parameter field (“Status” for instance) to enter the editing mode.

Parameter	Type	Description
Name	R/W	Allows giving a name to the interface. This is the name displayed in the WEB pages typically for selecting the ethernet interface.
Ethernet interface name	Read	Displays the “real low level” name of the ethernet ports, as they can be read from the IQOYA back panel. This parameter can’t be changed.
Status	Read/Write	This parameter allows enabling/disabling the interface Default value=Running Possible values: Running: ethernet port is enabled. Stopped: ethernet port is disabled
Speed and duplex mode obtained	Read	Displays the current speed and mode of the ethernet interface.
Speed and duplex mode asked	Read/Write	Allows selecting the working mode of the ethernet interface. Possible values are as follows: <div style="border: 1px solid black; padding: 5px; margin: 5px 0;"> Autonegotiation </div> <div style="border: 1px solid black; padding: 5px; margin: 5px 0;"> Autonegotiation 1000 Mbit/s full duplex 100 Mbit/s full duplex 100 Mbit/s half duplex 10 Mbit/s full duplex 10 Mbit/s half duplex </div> We recommended to avoid the “Auto-negotiation” mode. Select the mode supported by the network node connected the IQOYA.

DHCP	Read/Write	Allows enabling/disabling DHCP (Dynamic Host Configuration Protocol). Default value is OFF (disabled). Click on “On” to enable DHCP. This mode disables the following parameters.
IPv4 address	Read if DHCP is On Write if DHCP is Off	DHCP Off Default value is: 192.168.0.100 for Eth1, 192.168.1.100 for Eth2, 192.168.2.100 for Eth3, 192.168.3.100 for Eth4 Enter the IP address of this ethernet interface. DHCP On Displays the IP address automatically set by DHCP.
Subnet mask	Read if DHCP is On Write if DHCP is Off	DHCP Off Enter the mask of the subnetwork this ethernet port belongs to. DHCP On Displays the subnetwork mask automatically set by DHCP.
Default gateway	Read if DHCP is On Write if DHCP is Off	DHCP Off Enter the default gateway IP address. Streams sent beyond the subnets configured on LAN1 to 4 will pass through this gateway except if specific routing rules has been defined in the IP routing page.  Only one default gateway must be configured for all the ethernet interfaces. If several gateways has to be used, one can be set as default gateway, the others must be the subject of routing rules in the IP routing page. DHCP On Displays the default gateway IP address automatically set by DHCP.
Primary DNS	Read if DHCP is On Write if DHCP is Off	DHCP Off Enter the IP address of the primary DNS (if any). DHCP On Displays the IP address of the DNS automatically set by DHCP.
Secondary DNS	Read if DHCP is On Write if DHCP is Off	DHCP Off Enter the IP address of the secondary DNS (if any). DHCP On Displays the IP address of the secondary DNS automatically set by DHCP (may be empty).

8.1.1.3.2 Preferences -> Network -> VLAN

This page allows declaring VLANs on the ethernet interfaces. No VLAN is declared by default. Multiple VLANs can be declared for each ethernet interface.

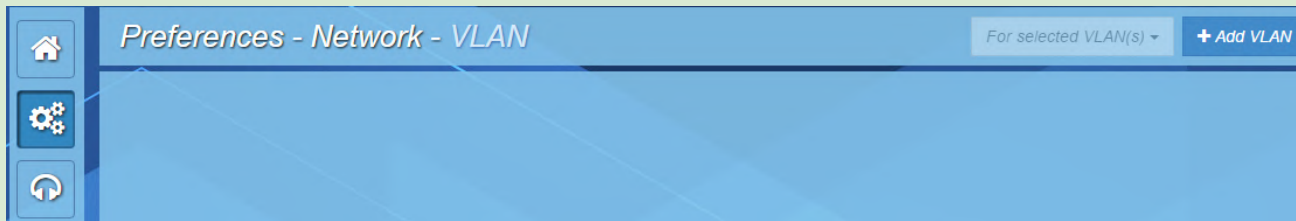

Click on “+Add VLAN” to declare a new VLAN.

Add VLAN x

Network interface: ?

VLAN ID:

Name:

Status: ?

Priority: ?

IPv4 address:

Netmask:

Parameter	Type	Description
Network interface	Read/Write	Select the network interface that will support the VLAN (ETH1 to ETH4)
VLAN ID	Read/Write	Enter the VLAN ID in the range 1--4094. Avoid ids 1002 to 1005 which are reserved.
Name	Read/Write	Enter a logical name for this VLAN
Status	Read/Write	Allows enabling/disabling this VLAN. Select “Running” to enable this VLAN. Select “Stopped” to disable this VLAN.
Priority	Read/Write	Enter the VLAN priority in the range [0-7].
IPv4 address	Read/Write	Enter the IP address of the selected ethernet port within this VLAN. If no value is entered, the IP address is the IP address of the selected ethernet port.
Netmask	Read/Write	Enter the netmask for this VLAN interface. If no value is entered, the netmask is the same as the selected ethernet port netmask.

8.1.1.3.3 Preferences -> Network -> IP routing

This page allows viewing the current IP routing table, downloading it, and uploading a modified IP routing table.

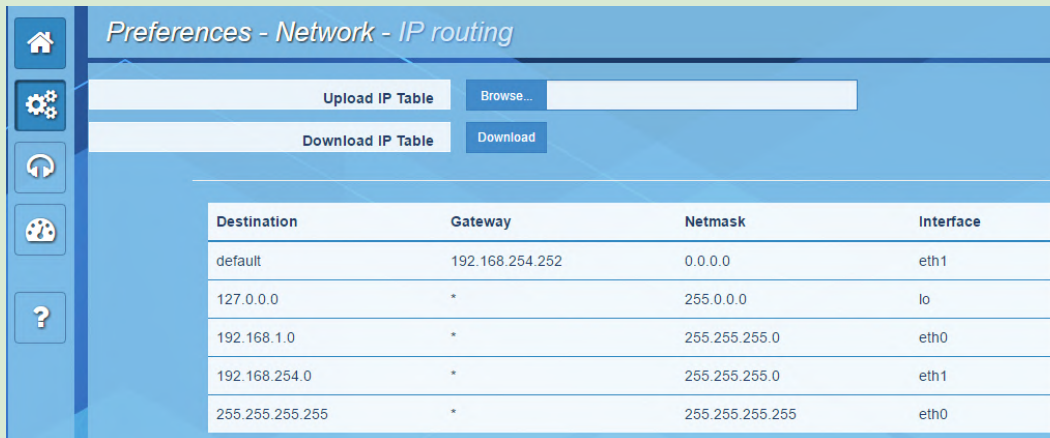

Destination	Gateway	Netmask	Interface
default	192.168.254.252	0.0.0.0	eth1
127.0.0.0	*	255.0.0.0	lo
192.168.1.0	*	255.255.255.0	eth0
192.168.254.0	*	255.255.255.0	eth1
255.255.255.255	*	255.255.255.255	eth0

In case the routing table has to be modified, click on “Download”.

The routing table can be edited with a standard text editor (such as notepad). You may add IP routes, as described in the downloaded file. **Only the additional routes must appear in this file. Routes to directly accessible subnets are not present in this file and need not be added to this file.**

Note: In case you use more than one ethernet interface, do not declare several gateways. Declare instead one default gateway, for instance on Eth0, and declare routes on other ethernet interfaces through this routing table.

8.1.1.3.4 Preferences -> Network -> HTTP stream proxy

This page allows declaring a proxy used for HTTP streaming.

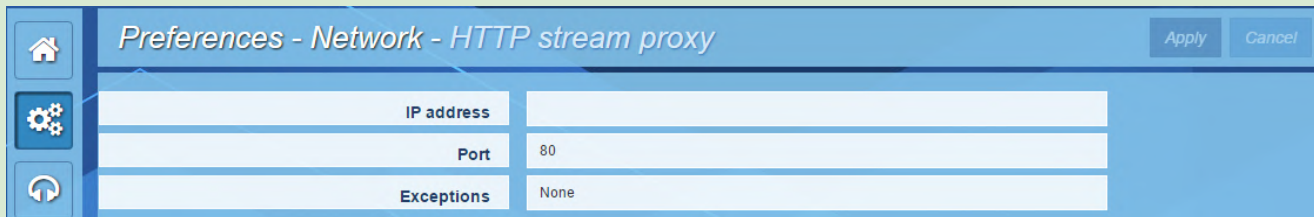

Parameter	Type	Description
IP address	Read/Write	IP address (or domain name) of the HTTP proxy.
Port	Read/Write	TCP Port for the HTTP proxy (80 by default)
Exceptions	Read/Write	Default is None. Select “Locals” to bypass the HTTP stream proxy for local IP addresses.

8.1.1.4 Preferences -> Auxiliary data

This section allows configuring the tunneling of serial data and status data.





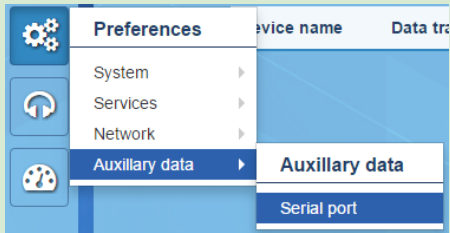

8.1.1.4.1 Preferences -> Auxiliary data -> Serial port

This pages allows enabling/disabling the RS232 port, and set its configuration.



To modify the parameters of a COM port, click on its  icon on the left column.

Edit Serial Port
✕

Device name	COM1	
Data transmission mode	Generic	
Baud rate	115200	
Data bits	8	
Stop bits	1	
Parity	None	
Status	Enable	

Close Save

Parameter	Type	Description
Device name	Read	Name of the RS232 port
Data transmission mode	Read/Write	Defines the way serial data are inserted into the IP audio stream. Generic: serial data are inserted as they arrive. UECP: serial data are inserted each time a complete RDS UECP frame is fully received from the RS232 port.
Baud rate	Read/Write	Serial port baud rate in bits/s, from 1200 bps to 40 Kbits/s
Data bits	Read/Write	Select the number of bits for each character (6, 7 or 8)
Stop bits	Read/Write	Enter the number of bits used to signal the end of a character: 1 or 2.
Parity	Read/Write	Select the method used for detecting errors on the RS232 port transmission: <ul style="list-style-type: none"> • None: No • Odd: number of bits of each character (including the parity bit) is always odd. • Even: number of bits of each character (including the parity bit) is always even.
Status	Read/Write	Enable: the COM port is enabled. Disable: the COM port is disabled.

Click on “Save” to confirm the changes.

8.1.1.4.2 Preferences -> Auxiliary data -> GPIO

X/LINK offers the possibility to use physical GPIOs, or virtual GPIOs through UDP ports. The status of the physical or virtual GPI's is tunneled in-band so that the decoder can output the status information on physical or virtual GPO's.

Virtual GPIO's allow third party applications to send/receive status information via IP to/from IQOYA.32 virtual GPI status can be tunneled.

Structure of a virtual status information frame over UDP

	0	1	2	3	4	5	6	7	8	9	10	11	12	13	15	16	17	18	19	20	21	22	23	24	25	26	27	28	29	31		
32-bit word 1:	Version number (4 bits) = 0000												User ID (24 bits)																			
32-bit word 2:	32 bits. Bit 0 = Status GPIO0 -> Bit 31 = Status GPI31																															
32-bit word 3	Validation mask (32 bits)																															

The validation mask validates the GPI statuses to be taken into account.

The page [Preferences -> Auxiliary data -> GPIO](#) allows enabling/disabling the in-band tunneling of GPI status information to GPO.

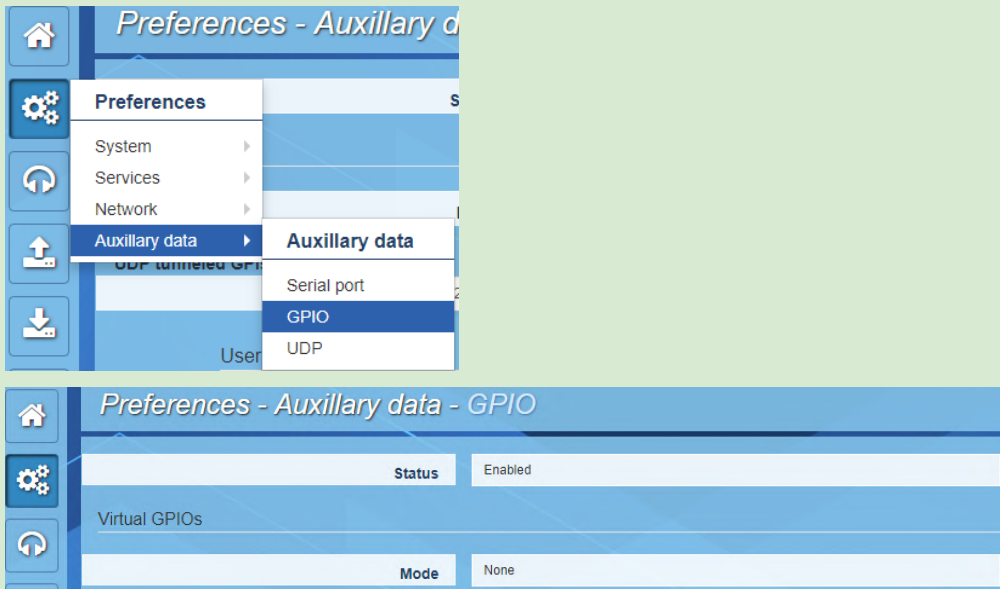

Status: Select enable to activate the status tunneling.

To declare virtual GPI's to be tunneled, select "In" from parameter "Mode".
 To declare virtual GPO's, select "Out" from parameter "Mode".
 To declare both virtual GPI's and GPO's, select "In & Out".

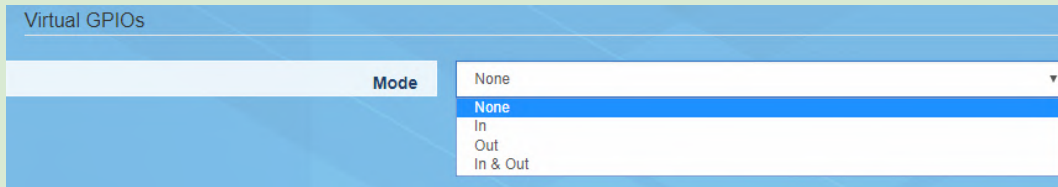

The following screen capture corresponds to the mode "In & Out".

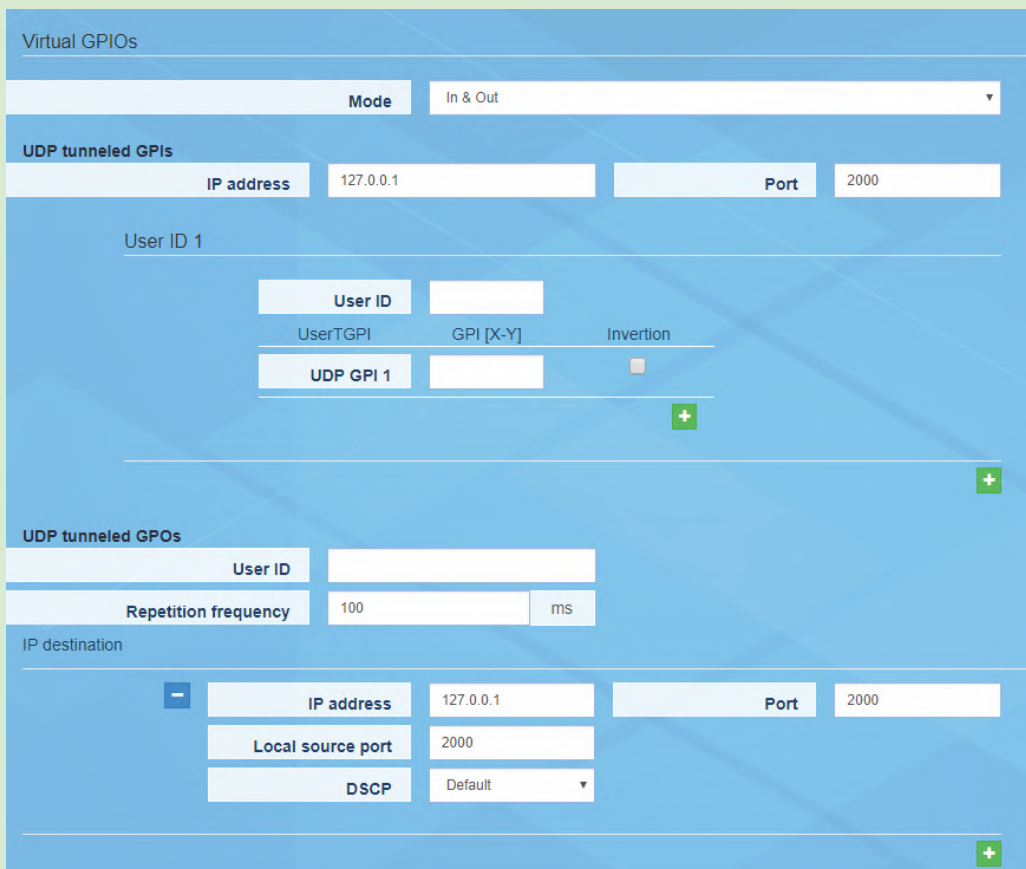

Parameter	Type	Description
UDP Tunneled GPIs		
User ID	Read/Write	Allows defining a group of Virtual GPIs (among 32 possible tunneled GPIs) sent by an application. The 32 virtual GPIs can be shared between several applications. The User ID identifies one given application.

UDP GPI1	Read/Write	Click on  to declare an additional input status. Enter for each input status (UDP GPIn) its rank among the 32 transported status.
UDP Tunneled GPOs		
User ID	Read/Write	Identifies the IQOYA that sends the Virtual GPOs frame.
Repetition frequency	Read/Write	Defines how often the GPO values have to be repeated so that the decoder does not miss a status change.
IP Destination:Port	Read/Write	IP@and UDP port the UDP frames of virtual GPOs are sent to.
DSCP	Read/Write	Quality of service giver to the virtual GPOs UDP frames.

8.1.1.4.3 Preferences -> Auxiliary data -> UDP

This page allows defining the UDP ports used for receiving and /or sending serial data over IP.

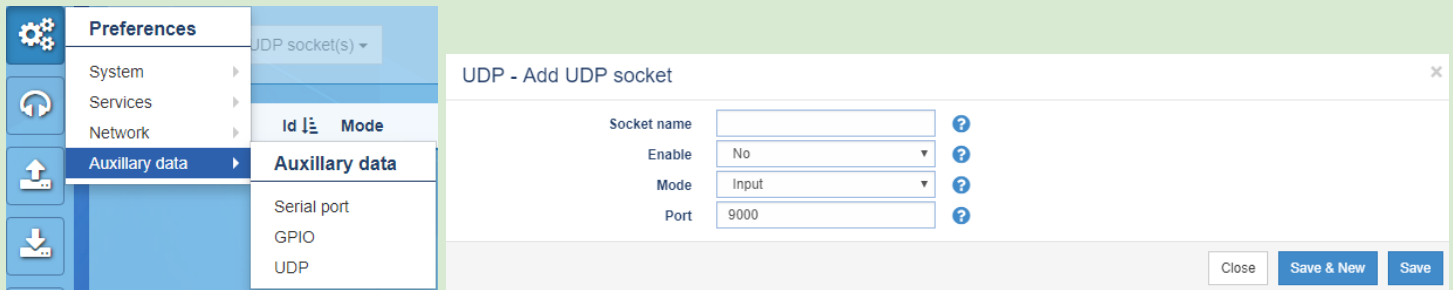

Parameter	Type	Description
Socket name	Read/Write	Name given to the UDP socket. This name allows selecting the socket for tunneling data, in the Send->IPService and Receive->Program pages.
Enable	Read/Write	Yes: socket is enabled. No, socket is disabled.
Mode	Read/Write	Input: IQOYA reads the data to be tunneled from the socket. Output: IQOYA sends data through this socket.
Port	Read/Write	UDP port of the socket

Serial data received via a UDP port are inserted in the IP audio stream, provided that this UDP port has been selected as the source of auxiliary data to be tunneled.

For an Icecast/Shoutcast, serial data have to conform to the standard ICY-metadata syntax.

8.1.2 Audio I/Os category of menus

This category gathers all the menus allowing for the configuration of the inputs that can be encoded, and the outputs that play decoded audio.

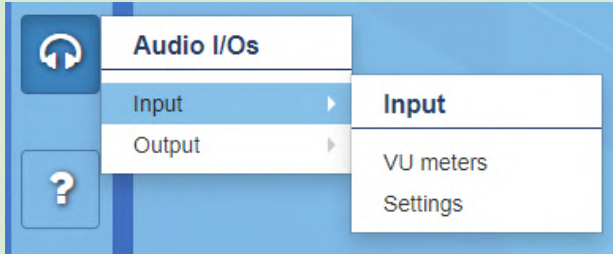

8.1.2.1 Audio I/O -> Input

8.1.2.1.1 Audio I/O -> Input -> VU meters

This page displays the level of the signals incoming on the inputs (Line analog, AES/EBU, or MAD1 depending on the X/LINK configuration).

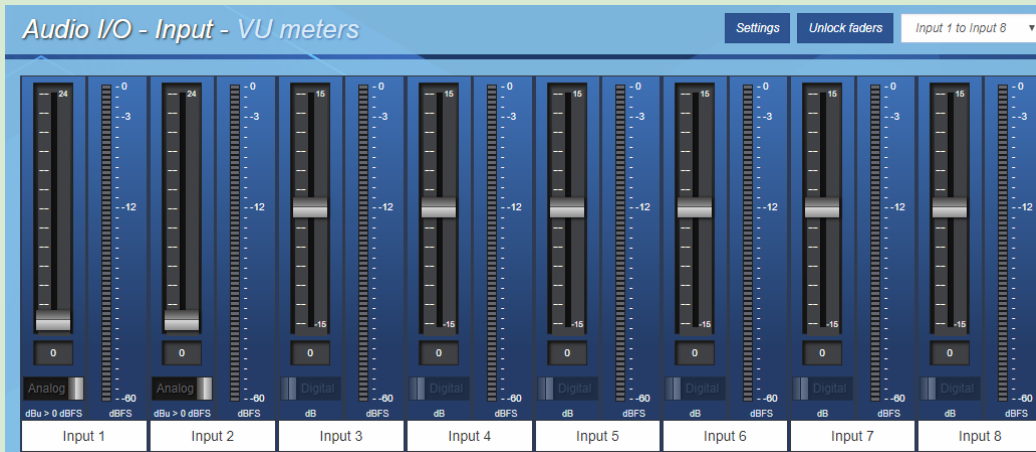

Displayed VU-meters unit is dBfs.

For a X/LINK with more than 8 mono channels (X/LINK-AES67 with additional optional I/O channels), the group of channels to be displayed is selectable from the top right menu.

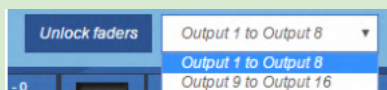

Select “Unlock faders” to change the input gains.

If the X/LINK features analog inputs, it is possible to adjust both the analog input gain and the digital input gain.

Selection of analog or digital gain is done thanks to the selector below the fader.

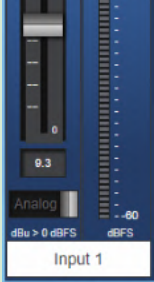
	<p>When Digital is selected, a digital gain/attenuation is applied to the input signal.</p>
	<p>When Analog is selected an analog gain/attenuation is applied to the input signal. The value displayed below the fader corresponds to the input signal level which gives 0 dBfs after analog to digital conversion</p>

Vu-meters settings

Click on the “Settings” button to adjust the bargraph display and the front panel LED vu-meters display (red zone, orange zone, and green zones).

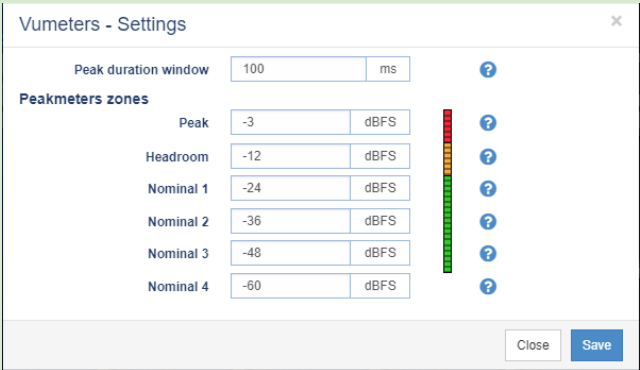
	<p>Peak duration window: duration of the display of the peak levels (from 20ms to 10000ms)</p> <p>Peak: Level value in dBfs above which the vu-meter is red</p> <p>Headroom: Level value in dBfs above which the vu-meter is orange.</p> <p>Nominal 1: Level value in dBfs above which the LED right below the headroom LED is highlighted in green.</p> <p>Nominal 2: Level value in dBfs above which the 3rd LED from the bottom is highlighted in green.</p> <p>Nominal 3: Level value in dBfs above which the 2nd LED from the bottom is highlighted in green.</p> <p>Nominal 4 :Level value in dBfs above which the 1rst LED from the bottom is highlighted in green.</p>
--	---

8.1.2.1.2 Audio I/O -> Input -> settings

This page allows the following:

- Selection of the input signals to be allocated to the encoder inputs
- naming of the encoder inputs
- Configuration of the input AES67, or RAVENNA, or Livewire AoIP streams



This page displays all the inputs proposed by your IQOYA.
The audio sources to be encoded (input Programs) are selected among these inputs.

	Displayed mono inputs	Number of mono inputs that can be selected for encoding
X/LINK-ST & X/LINK-LE	2 analog, 2 on AES/EBU, 2 AoIP(*)	2
X/LINK-DUAL	4 analog, 4 on AES/EBU, 4 AoIP(*)	4
X/LINK-AES67	AoIP(*)	2 (basic version Up to 16 depending the software option installed.

(*) AES67, RAVENNA, Livewire

Analog line input settings

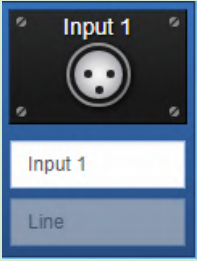
	<p>Click on the “Input” field to rename the input. The new name will appear in other WEB pages (Input Program). Audio levels are adjustable from the VU-Meters page.</p>
--	--

AES/EBU input settings



Click on the “Input” field to rename the input. The new name will appear in other WEB pages (Input Program). Audio levels are adjustable from the VU-Meters page.

The AES/EBU input features a hardware sample rate converter, which is useful when the AES/EBU input is not synchronous of the selected sampling clock source.

To enable the hardware SRC, select AES+SRC. To disable the hardware SRC, select AES. For AES transparent transport, select AES+TUN

AoIP input settings



Click on the “Input” field to rename the input. The new name will appear in other WEB pages (Input Program). Audio levels are adjustable from the VU-Meters page.

Click on “**Edit**” to be able to configure the input AoIP stream, as described below.

Click on “Metrics” to display the metrics on the configured AoIP stream. This is useful to get the minimum jitter value to be entered in the parameters. LED: if an AoIP stream is configured and it is well received the LED is green; The LED is red if the stream is not received, and grey if the stream reception is disabled.

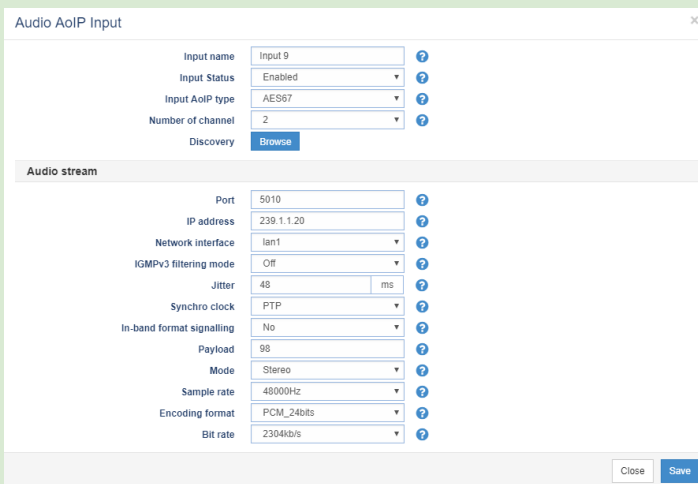

Input Name: the same as described above.

Input Status: Enable/disable.

Input AoIP type: AES67, RAVENNA, or Livewire

Number of channels: defines the number of audio channels to be extracted from this AoIP stream

When AES67 or RAVENNA type is selected, the

Browse button allows discovering the available AES67 or RAVENNA streams on all the networks. The list of parameters below is then filled in according to the selected AoIP stream.

Port	<input type="text" value="5010"/>
IP address	<input type="text" value="239.1.1.20"/>
Network interface	<input type="text" value="lan1"/>
IGMPv3 filtering mode	<input type="text" value="Off"/>
Jitter	<input type="text" value="48"/> ms
Payload	<input type="text" value="98"/>
Mode	<input type="text" value="Stereo"/>
Sample rate	<input type="text" value="48000Hz"/>
Audio format	<input type="text" value="PCM_24bits"/>
Bit rate	<input type="text" value="2304kb/s"/>

Settings for an AES67 stream

Most of the parameters below are automatically filled in after having browsed and selected an AES67 stream.

Port: UDP port number for receiving the stream

IP address: multicast or unicast IP@

Network interface: network interface (LAN or VLAN) used for receiving the stream.

IGMPv3 filtering: Allows including or excluding source IP addresses of the multicast stream. If *Include* or *Exclude* value is selected, the list of IP addresses can be entered via the following interface:

IP address 1	<input type="text"/>	<input type="button" value="ⓘ"/>	<input type="button" value="+"/>
--------------	----------------------	----------------------------------	----------------------------------

Jitter: enter the jitter value. This value must be at least equal to the jitter value reported from the Metrics on the stream.

Payload: Set to 98.

Mode: defines the number of channels to be considered from the stream (Mono or stereo).

Sample rate: 32 kHz, 44.1 kHz, or 48 kHz

Audio Format: PCM 12, 16, 20 or 24 bits

Port	<input type="text" value="5010"/>
IP address	<input type="text" value="239.1.1.20"/>
Network interface	<input type="text" value="lan1"/>
IGMPv3 filtering mode	<input type="text" value="Off"/>
Jitter	<input type="text" value="48"/> ms
Payload	<input type="text" value="98"/>
Mode	<input type="text" value="Stereo"/>
Sample rate	<input type="text" value="48000Hz"/>
Audio format	<input type="text" value="PCM_16bits"/>
Bit rate	<input type="text" value="1536kb/s"/>

Settings for a RAVENNA stream

Most of the parameters below are automatically filled in after having browsed and selected a RAVENNA stream.

Port: UDP port number for receiving the stream

IP address: multicast or unicast IP@

Network interface: network interface (LAN or VLAN) used for receiving the stream.

IGMPv3 filtering: Allows including or excluding source IP addresses of the multicast stream. If *Include* or *Exclude* value is selected, the list of IP addresses can be entered via the following interface:

IP address 1	<input type="text"/>	<input type="button" value="ⓘ"/>	<input type="button" value="+"/>
--------------	----------------------	----------------------------------	----------------------------------

Jitter: enter the jitter value. This value must be at least equal to the jitter value reported from the Metrics on the stream.

Payload: Set to 98.

Mode: defines the number of channels to be considered from the stream (Mono or stereo).

Sample rate: 32 kHz, 44.1 kHz, or 48 kHz

Audio Format: PCM 12, 16, 20 or 24 bits

Livewire channel	<input type="text" value="0"/>	<p>Settings for a Livewire stream</p> <p>Livewire channel:</p> <p>Port: UDP port number for receiving the stream</p> <p>IP address: multicast or unicast IP@</p> <p>Network interface: network interface (LAN or VLAN) used for receiving the stream.</p> <p>IGMPv3 filtering: Allows including or excluding source IP addresses of the multicast stream. If <i>Include</i> or <i>Exclude</i> value is selected, the list of IP addresses can be entered via the following interface:</p> <div style="border: 1px solid #ccc; padding: 5px; margin-bottom: 10px;"> <p>IP address 1 <input style="width: 100%;" type="text"/> ?</p> <p style="text-align: right; color: green; font-weight: bold;">+</p> </div> <p>Jitter: enter the jitter value. This value must be at least equal to the jitter value reported from the Metrics on the stream.</p> <p>Payload: Set to 98.</p>
Port	<input type="text" value="5010"/>	
IP address	<input type="text" value="239.1.1.20"/>	
Network interface	<input type="text" value="lan1"/> ▼	
IGMPv3 filtering mode	<input type="text" value="Off"/> ▼	
Jitter	<input type="text" value="48"/> ms	
Payload	<input type="text" value="98"/>	

It is possible to enable or disable the reception of one or several declared AoIP input streams.

- Select the declared input streams through the check box on the left of “Edit”

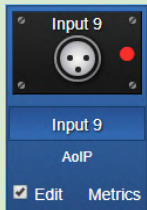

- Select Enable or Disable from the “For selected input(s)” list box on the top left.

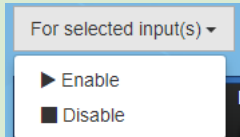

Click on “Apply” to confirm the changes.

8.1.2.2 Audio I/O -> Output

8.1.2.2.1 Audio I/O -> Output -> VU meters

This page displays the level of the output signals.



Displayed VU-meters unit is dBfs.

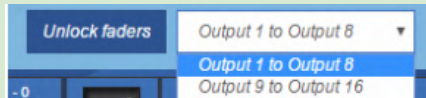

For a X/LINK with more than 8 mono channels (X/LINK-AES67 with additional optional I/Os), the group of channels to be displayed is selectable from the top right menu.



Select “Unlock faders” to change the output gains.

If the X/LINK features analog outputs, it is possible to adjust both the analog output gain and the digital output gain.

Selection of analog or digital gain is done thanks to the selector below the fader.

	<p>When Digital is selected, a digital gain/attenuation is applied to the output signal.</p>
	<p>When Analog is selected, an analog gain/attenuation is applied to the output signal. The value displayed below the fader corresponds to the level of the output signal for a 0 dBfs digital signal.</p>

Vu-meters settings

Click on the “Settings” button to adjust the bargraph display and the front panel LED vu-meters display (red zone, orange zone, and green zones).

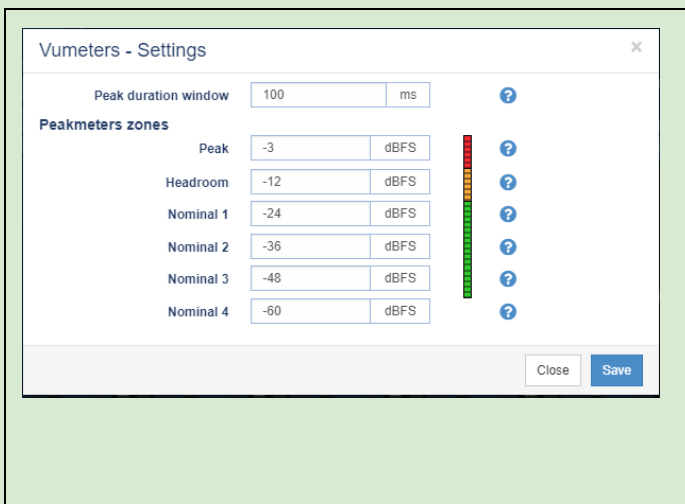

Peak duration window: duration of the display of the peak levels (from 20ms to 10000ms)
Peak: Level value in dBfs above which the vu-meter is red
Headroom: Level value in dBfs above which the vu-meter is orange.
Nominal 1: Level value in dBfs above which the LED right below the headroom LED is highlighted in green.
Nominal 2: Level value in dBfs above which the 3rd LED from the bottom is highlighted in green.
Nominal 3: Level value in dBfs above which the 2nd LED from the bottom is highlighted in green.
Nominal 4 :Level value in dBfs above which the 1rst LED from the bottom is highlighted in green.

8.1.2.2.2 Audio I/O -> Output -> settings

This page allows the following:

- assign a physical output or AoIP output to a decoder output signal
- naming of the encoder outputs
- Configure the AoIP output(s)



This page displays all the inputs proposed by your IQOYA.

The audio sources to be encoded (input Programs) are selected among these inputs.

	Displayed mono outputs	Number of mono outputs that can be selected for output programs destinations
X/LINK-ST & X/LINK-LE	2 analog, 2 on AES/EBU, 2 AoIP(*)	2
X/LINK-DUAL	4 analog, 4 on AES/EBU, 4 AoIP(*)	4
X/LINK-AES67	AoIP(*)	From 2 to 16 depending the software option installed.

(*) AES67, RAVENNA, Livewire

Analog line output settings

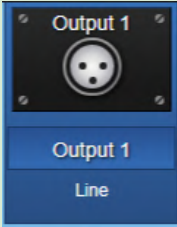
	<p>Click on the “output” field to rename the output. The new name will appear in other WEB pages (output Program). Audio levels are adjustable from the VU-Meters page.</p>
--	---

AES/EBU output settings

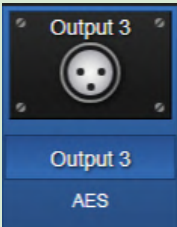
	<p>Click on the “output” field to rename the output. The new name will appear in other WEB pages (Output Program). Audio levels are adjustable from the VU-Meters page. For AES transparent transport, select AES+TUN by clicking on the <i>AES</i> field</p>
--	---

AoIP output settings

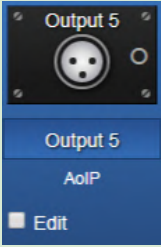
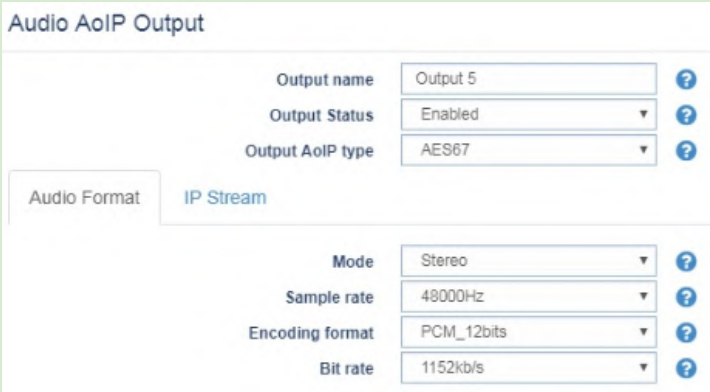
	<p>Click on the “output” field to rename the output. The new name will appear in other WEB pages (Output Program). Audio levels are adjustable from the VU-Meters page. Click on “Edit” to be able to configure the output AoIP stream, as described below.</p>
	<p>Output Name: the same as described above. Output Status: Enable/disable. Output AoIP type: AES67, RAVENNA, or Livewire Audio Format Tab Sample rate: 32 kHz, 44.1 kHz, or 48 kHz Audio Format: PCM 12, 16, 20 or 24 bits</p>

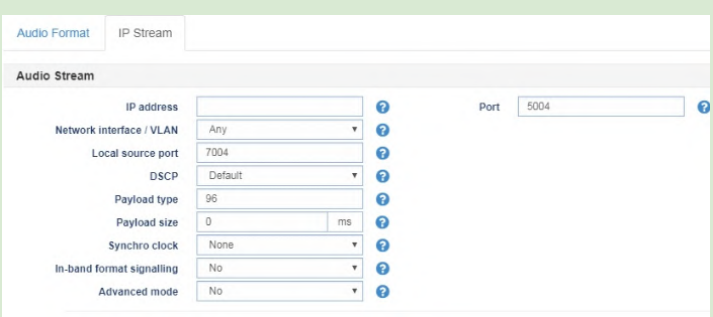
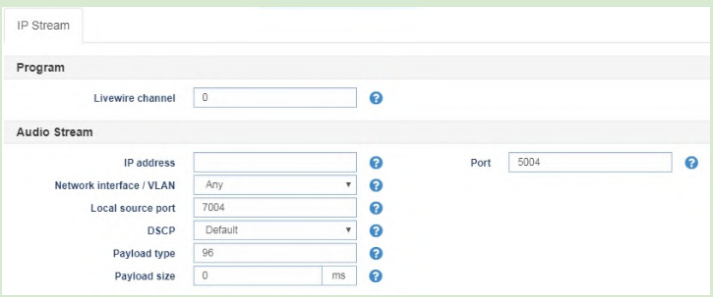
	<p>Settings for an AES67/RAVENNA output stream</p> <p>IP address: multicast or unicast destination IP@ Port: destination UDP port number Local Source Port Network interface: network interface (LAN or VLAN) used for sending the stream. DSCP: Value for the QoS of the stream. Payload type: Set to 98 for PCM. Payload size: When set to 0, the payload size is equal to the processing granularity (Preferences/Audio setup). Set 1 ms for 48 samples at 48 kHz (interoperable AES67 profile).</p>
	<p>Settings for a Livewire output stream</p> <p>Livewire channel: number of the Livewire channel IP address: multicast or unicast IP@ Port: UDP port number for receiving the stream Network interface: network interface (LAN or VLAN) used for receiving the stream. Local source port: Local UDP port used to send the stream DSCP: Value for the QoS of the stream. Payload type: Set to 98 for PCM. Payload size: It is recommended to set this value to 5, which corresponds to the Livewire “standard” mode (240 samples per packet).</p>

It is possible to enable or disable the sending of one or several declared AoIP output streams.

- Select the declared output streams through the check box on the left of “Edit”

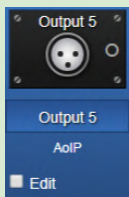

- Select Enable or Disable from the “For selected input(s)” list box on the top left.

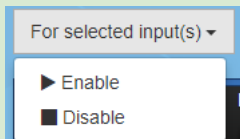

Click on “Apply” to confirm the changes.

8.1.2.3 Audio I/O -> Audio Bus

Audio buses are useful for the transcoding of IP streams, or for mixing several decoded IP streams. An audio bus can be the destination of one or several output programs, and the source of input programs. The number of available audio buses is defined by the license. Audio buses are optional.

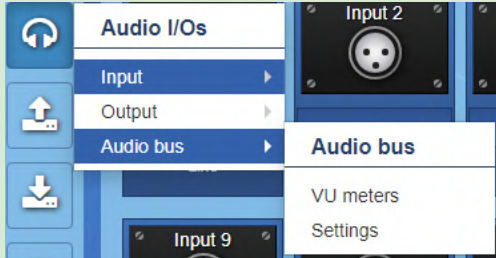

8.1.2.3.1 Audio I/O -> Audio Bus -> Vu meters

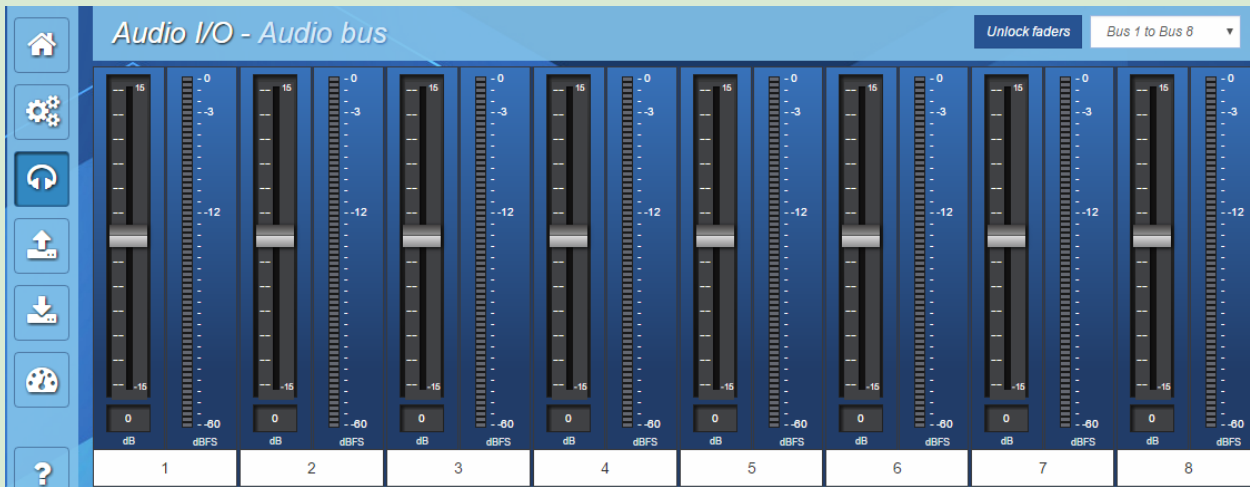

Audio buses are displayed in groups of 8 channels. For a X/LINK offering more than 8 mono channels for the buses, the group of channels to be displayed is selectable from the top right menu.

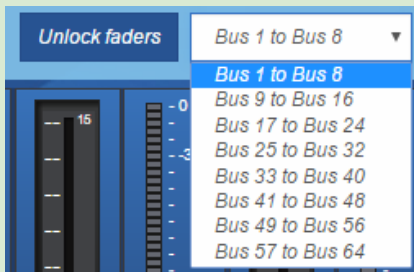

8.1.2.3.2 Audio I/O -> Audio Bus -> Settings



Click on the “name” field to rename the audio bus. The new name will appear in other WEB pages. Right below the name of the bus, its type can be selected:

- AudioBus + Tun: select this option in case AES transparency is needed (transport of samples and user bits)
- AudioBus: default value. Only audio samples are transported.

8.1.3 “Send” category of menus

This category allows defining the programs and the IP services to be streamed, but also getting the status of the IP services.

The principle consists in first declaring the programs, and then declaring the IP services that carry the programs.

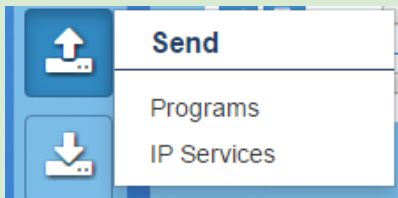

8.1.3.1 Send -> Programs

This page allows viewing and declaring the audio encoding instances: the programs.

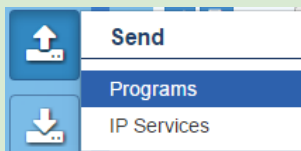

It can be accessed either from the left column, or from the icon “Go to programs” on the top right of the IP

Services page

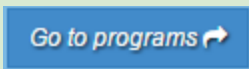

Send - Programs Go to IP Service ↗

Delete selected program(s) + Add Program

<input type="checkbox"/>	Id	Program Name	Mode	First Input	Sample rate	Format	Bitrate	IP Service
<input checked="" type="checkbox"/>	1	Prog 1	7.1	Input 1	48000Hz	PCM_12bits	4608kb/s	Used
<input type="checkbox"/>	2	Prog 2	Stereo	Input 1	48000Hz	AAC-LC	288kb/s	Unused
<input type="checkbox"/>	3	Prog3	Stereo	Input 1	48000Hz	AAC-LC	288kb/s	Unused

In case some programs are already created, they are listed in the Programs page, with their characteristics: name, mode, first audio input, sample rate, audio format, bitrate, IP Service using this Program.

If a Program is used in at least one IP Service, the icon  is displayed on the left of its name, and “Used” appears in the column “IP Service”. The IP services that use this program are listed when moving the mouse above “Used”.

<input type="checkbox"/>	Id	Program Name	Mode	First Input	Sample rate	Format	Bitrate	IP Service
<input checked="" type="checkbox"/>	1	Prog 1	7.1	Input 1	48000Hz	PCM_12bits	4608kb/s	Used Send 1, gdfhsh
<input type="checkbox"/>	2	Prog 2	Stereo	Input 1	48000Hz	AAC-LC	288kb/s	Unused

If a Program is not used by any IP Service, the selection button is displayed on the left of its name. A Program can be associated to one IP Service. Only unused Programs can be selected in an IP Service.

To declare a new Program, click on the icon  + Add Program.

Send - Edit Program ✕

Program Silence detection

Name ?

Input type ?

First channel ?

Mode ?

Sample rate ?

Encoding format ?

Bit rate ?

Give a unique name to the program. Click on “Save” to confirm the parameters. Click on “Close” to discard the changes. Click on “Save & New” to confirm the settings, and duplicate them so that to create a new program with similar settings, except the name.

To edit an existing Program, click on the icon  in the left side of the Program line.

A new program can be created by duplicating one of the displayed programs; click on the icon  in front of the program to be duplicated.

Parameter	Type	Description
Name	Read/Write	Name given to the encoding instance. This name will be selected when declaring an IP service.
Input type	Read/Write	Audio source of the program: it can be an audio input, or an audio bus, or an AoIP input
First channel	Read/Write	First input channel of the audio signal to be encoded, to be selected among the list of input channels.
Mode	Read/Write	Mono, Stereo, Multi-channel 5.1
Sample rate	Read/Write	Frequency of the encoded audio, to be selected from the list box. It may be different from the IQOYA sampling frequency)
Encoding format	Read/Write	Audio format of the encoding, to be selected from the list box.
Bit rate	Read/Write	Bit rate of the encoded audio.

Silence detection parameters

Click on the “Silence detection” tab to set the criteria for silence detection on this program. An alarm is signalled when silence is detected, and it is reset when signal is detected again.

It is also possible to automatically stop/start the streaming upon silence/signal detection. This can be configured from the IP Service page (see next paragraph **Send -> IP services**).

Send - Edit Program
×

Program

Silence detection

Input signal for silence detection

Silence threshold

Silence duration

Signal threshold

Signal duration

Signal drop duration

At least one channel	▼	?
-43.00	dB	?
1000	ms	?
-43.00	dB	?
2000	ms	?
1000	ms	?



Close
Save

<p><i>Input signal for silence detection</i></p>	<p>In case IQOYA is used as an encoder, it can generate an alarm when silent audio is detected on the audio inputs, and set this alarm off when audio signal is detected again. (Note that all the alarms handled by IQOYA can be enabled/disabled from the “Alarms setup” menu).</p> <p>The parameter “Input signal for silence detection” allows defining on which input signal the silence detection is applied. Possible choices are:</p> <ul style="list-style-type: none"> - Mean of left + right channels: compares the mean value of a left and right sample to the threshold. In case the calculated values are always lower to the silence threshold during the defined silence duration, silence condition is reached. - Left channel only: compares the left channel samples to the silence threshold. In case the sample values are always lower to the silence threshold during the defined silence duration, silence condition is reached. - Right channel only: compares the right channel samples to the silence threshold. In case the sample values are always lower to the silence threshold during the defined silence duration, silence condition is reached. - Left and right channels: compares both the left and right channel samples to the silence threshold. In case the sample values on both channels are always lower to the silence threshold during the defined silence duration, silence condition is reached. - At least one channel: compares both the left and right channel samples to the silence threshold. In case the sample values on at least one on the two channels are always lower to the silence threshold during the defined silence duration, silence condition is reached.
<p><i>Silence threshold & Silence duration</i></p>	<p>Silent audio is defined through these two parameters, expressed in dBfs.</p> <p>When audio level is below the threshold value during at least the defined duration, the alarm “Analog audio in silent” or “Digital audio in silent” is set (if it is enabled from the “Alarms setup” menu).</p>
<p><i>Signal threshold Signal duration Signal drop duration</i></p>	<p>Audio signal is defined through the three parameters. Audio signal is considered as recovered if all the following conditions are true:</p> <ul style="list-style-type: none"> • Audio level exceeds the Signal threshold (dBfs) within the “Signal duration” analysis window (ms). • Audio level does not stay below the Signal threshold during the “Signal drop duration”, within the “Signal duration” analysis window. <p>Note the following rule: $\text{Signal drop duration} \leq (\text{Signal duration} / 2)$.</p> <p>Once signal is recovered, the alarm “Analog audio in silent” or “Digital audio in silent” is reset (if it is enabled from the “Alarms setup” menu).</p>

Click on Save button to confirm the new Program.

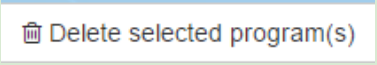
To delete one or several unused programs, select them by clicking on the icon  on the left of their names, and



click on the button  on the top of the Programs list.

If all Programs are unused and you want to delete them all, click on the icon  on the left of the column title “Program Name” (this selects all the Programs), and click on the button  on the top of the Programs list.
 Confirm or cancel your choice in the displayed confirmation window.

8.1.3.2 Send -> IP services

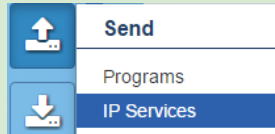
This page allows viewing and declaring the IP Services to be streamed over IP.



It can be accessed either from the left column , or directly from the icon “Go to IP Service”  on the top right of the Programs page.





IP Service	Program	Tunneled serial ports	Tunneled GPIs	Service Bitrate	FEC	Status
pcm241_15004				-	Yes	●
testMPTS				836 kb/s	No	●
	1					●
	2					●

In case some IP Services are already created, they are listed in the IP Services page, with their characteristics: Name, Program, Tunneled ports, Tunneled GPIs, bitrate, FEC, Status.

The program(s) carried by an IP service can be displayed by clicking on the icon  right on the left of the IP service name (an IP service can contain several programs in case of MPEG-TS MPTS encapsulation).

To declare a new IP Service, click on the icon .

A new IP service can also be created by duplicating an existing one. Click on the icon  on the left of the IP service to be duplicated.

To start, stop, or delete an IP service, check the box on the left of its name  , and select the appropriate action:

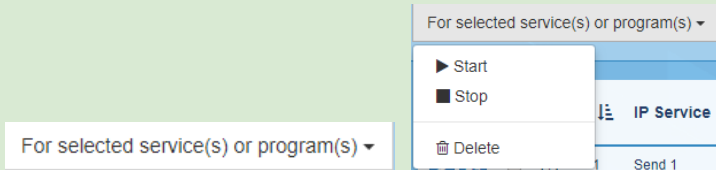

Note that a list of consecutive service can be selected by clicking on the first service check box, and shift clicking on the check box of the last service of the list.

Non consecutive services can be selected by CTRL clicking on their check boxes.

To edit an existing IP Service, click on the icon  in right end of the IP Service line. The following window is displayed.

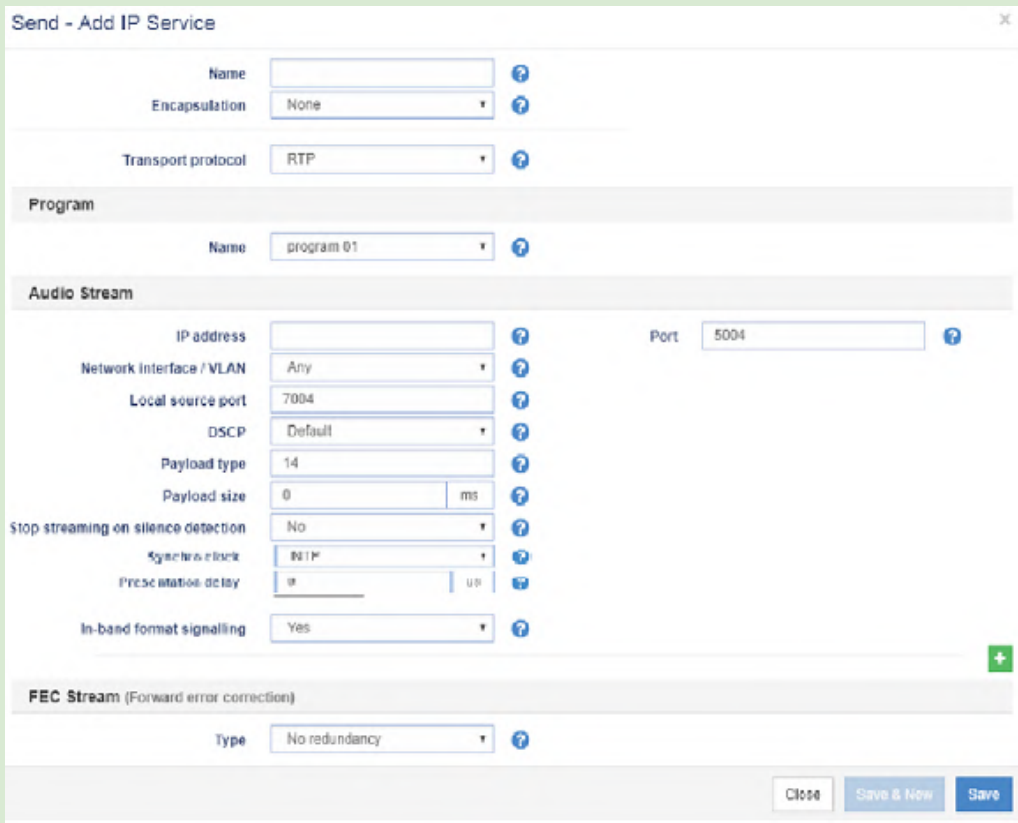

Parameter	Type	Description
Name	Read/Write	Name given to this IP service

Encapsulation	Read/Write	<p>None: The IP Service includes one Program, and audio data are not encapsulated (raw mode).</p> <p>MPEG-TS MPTS: The IP Service includes several Programs which are multiplexed in a single MPEG-TS stream</p>
---------------	------------	--

Encapsulation = None

Program : Name	Read/Write	Select the Program to be streamed from the list of Programs. A Program can be used by several IP services.
Program: Tunneled serial port	Read/Write	If there is a serial port hardware option installed, select the serial port that provides the serial data to be tunnelled in-band.
Program: Tunneled GPIs	Read/Write	If there is a GPIO hardware option installed, enter a list of GPI numbers which status is to be tunnelled in-band. Numbers start from 1 and must be separated by commas
Program: Transport protocol	Read/Write	<p>Select RTP, UDP, or HTTP protocol.</p> <p>HTTP is to be used for streaming to an Icecast/Shoutcast server.</p> <p>For other applications, we recommend to select RTP.</p> <p>UDP is to be used only if the equipment that receives the stream does not support standard ACIP RTP streams.</p>
Audio stream: IP address	Read/Write	Destination IP address or domain name.
Audio stream: Port	Read/Write	Enter the destination UDP port for RTP or UDP protocols, or the destination TCP port for HTTP streaming.
Audio stream:File path or mount point	Read/Write	<p>Valid if Transport protocol = HTTP</p> <p>Example: server URL= http://streamer.myorganization.com:6400/M1</p> <p>Mount point is to be set to: /M1</p>
Audio stream: Username	Read/Write	Valid if Transport protocol = HTTP. Username to access the server
Audio stream: password	Read/Write	Valid if Transport protocol = HTTP. Password to access the server
Audio stream: Network interface/VLAN (for RTP or UDP)	Read/Write	<p>Select the network interface or VLAN for this stream.</p> <p>In case the target address is unicast, select "Any" so that the Eth interface is determined automatically according to this IP address, or select a VLAN.</p> <p>In case the target IP address is multicast, select the Eth interface or the VLAN.</p>
Audio stream: Local source port (for RTP or UDP)	Read/Write	Local UDP port number of IQOYA X/LINK
Audio stream: DSCP (for RTP or UDP)	Read/Write	Select the quality of service (QoS) class of the stream.
Audio stream: Payload type (For RTP)	Read/Write	<p>RTP payload value that defines the audio profile. Standard values are:</p> <ul style="list-style-type: none"> • 0 for G711 • 9 for G722; 14 for MPEG

		<ul style="list-style-type: none"> 96 for AAC, Opus
Audio stream: Payload size (for RTP and UDP)	Read/Write	<p>Size (in ms) of the audio transported by an RTP frame.</p> <p>For unframed formats (like PCM, G7xx), payload size value is rounded to the nearest multiple value that is equal or higher than the processing granularity value.</p> <p>For framed formats (like MPEG, AAC), payload size value is rounded to the nearest multiple value equal or higher than the frame size.</p>
Audio stream: Stop streaming on silence detection	Read/Write	<p>IQOYA can automatically stop streaming and restart streaming upon silence/signal detection on the audio source. This feature can be enabled by setting this option to “Yes”.</p> <p>As a consequence, a decoder receiving the stream will switch to a backup when silence is detected on the input of the encoder that generates the stream.</p> <p>Set this option to “No” if you want the encoder to stream even when the audio source is silent.</p>
Audio stream:Synchro Clock (for RTP and UDP)	Read/Write	<p>None, or NTP.</p> <p>NTP can be selected if the option “NTP based audio synchro” is installed.</p>
Audio stream:Presentation delay	Read/Write	<p>Valid if Synchro Clock is set to NTP.</p> <p>Offset of time added to the current NTP time for time-stamping the IP packets so that several decoders play the packets at the same time. This value, expressed in microseconds, must be at least equal to the maximum network transport time for an IP packet to reach the target decoders.</p> <p>Once the encoder and the decoders are configured, this value can be tuned by checking the IP metrics. The maximum value is 2 000 000 microseconds (2 seconds) for unframed audio formats (PCM, Opus G7xx), and 256 frames for framed audio formats (MPEG, AAC). In MPEG Layer 2 48 kHz, this corresponds to 6 seconds (6 000 000 microseconds).</p>
In-band format signalling	Yes/No	<p>Yes: the description of the audio format is inserted in the IP audio stream so that the decoder can automatically adapt to the received format. This works only with IQOYA encoders and decoders.</p> <p>In this mode, FEC stream is sent to the same destination IP address as the IP audio stream, on UDP port +2.</p> <p>No: the decoder must be configured to receive the appropriate audio format.</p> <p>In this mode, FEC stream destination IP address and UDP port can be configured.</p>

Click on the icon  on the bottom right of the page to add an IP destination.

IP address ? Port ?
 Network interface / VLAN ?

Enter the new target IP address, UDP port, and the network interface through which the stream is sent.

Click on the icon to remove a destination.

An FEC can be selected. FEC consists in sending additional data so that the decoder can recover lost packets. The amount of additional frames defines the recovery performance.

FEC Stream (Forward error correction)

Type ?

<p>No redundancy</p> <ul style="list-style-type: none"> "+50% bandwidth, recovery 2, 1 stream (FEC)" "+100% bandwidth, recovery 3, 2 streams (audio+FEC)" "+100% bandwidth, recovery 4, 2 streams (audio+FEC)" "+50% bandwidth, recovery 1/2, 2 streams (audio+FEC)" "+33% bandwidth, recovery 1/3, 2 streams (audio+FEC)" "+25% bandwidth, recovery 1/4, 2 streams (audio+FEC)" "+20% bandwidth, recovery 1/5, 2 streams (audio+FEC)" "+10% bandwidth, recovery 1/10, 2 streams (audio+FEC)" "+100% bandwidth, dual stream with no delay" "+100% bandwidth, dual stream with 100 ms delay" "+100% bandwidth, dual stream with 200 ms delay" "+100% bandwidth, dual stream with 300 ms delay" "+100% bandwidth, dual stream with 400 ms delay" "+100% bandwidth, dual stream with 500 ms delay" "+100% bandwidth, dual stream with 600 ms delay" "+100% bandwidth, dual stream with 700 ms delay" "+100% bandwidth, dual stream with 800 ms delay" "+100% bandwidth, dual stream with 900 ms delay" "+100% bandwidth, dual stream with 1000 ms delay" 	<p>FEC on 1 stream means that additional data are sent in the IP audio stream (in-band).</p> <p>FEC on 2 streams means additional data are sent as a second IP stream.</p> <p>Dual stream FEC mean that the IP steam is duplicated. When no delay is selected, primary stream and redundant stream are sent at the same time. When a delay is selected, redundant stream is delayed compared to the primary stream.</p>
---	---

In case parameter "In-band format signalling" is set to "Yes", the destination IP address and UDP port of the FEC stream cannot be configured. The destination IP address is the same as for the primary stream, and the destination UDP port is equal to "primary stream destination UDP port + 2".

FEC Stream (Forward error correction)

Type ?

Payload type ?

In case parameter “In-band format signalling” is set to “No”, the destination IP address and UDP port of the FEC stream can be configured.

FEC Stream (Forward error correction)

Type ?

IP address ?

Port ?

Network interface / VLAN ?

Local source port ?

DSCP ?

Payload type ?

FEC stream: IP address	Read/Write	Enter the destination IP address (unicast or multicast) of the FEC stream.
FEC stream: Port	Read/Write	Enter the destination UDP port of the FEC stream.
FEC stream: Network interface/VLAN	Read/Write	Select the network interface or VLAN for this FEC stream. In case the target address is unicast, select “Any” so that the Eth interface is determined automatically according to this IP address, or select a VLAN. In case the target IP address is multicast, select the Eth interface or the VLAN.
FEC stream: Local source port	Read/Write	Local UDP port number of IQOYA X/LINK
FEC stream: DSCP	Read/Write	Select the quality of service (QoS) class of the FEC stream.
FEC stream: Payload type	Read/Write	RTP payload of the FEC stream. Value 98 is recommended.

Click on “Save” to confirm the settings. Click on “Save & New” to confirm the settings and create a new IP service with the same parameters.

Click on “Close” to discard the settings.

Static metadata for Icecast/Shoutcast streaming

Metadata can be added by selecting “Yes” for the “Yellow Pages” parameter (YP Settings).

Yellow Pages

YP Settings Yes Public Server No

Each new metadata field can be displayed by clicking on  .

Yellow Pages

YP Settings Yes Public Server No

<input type="button" value="-"/>	Stream Name	<input type="text"/>
<input type="button" value="-"/>	Stream Description	<input type="text"/>
<input type="button" value="-"/>	Stream URL	<input type="text"/>
<input type="button" value="-"/>	Stream Genre	<input type="text"/>
<input type="button" value="-"/>	ICQ #	<input type="text"/>
<input type="button" value="-"/>	AIM	<input type="text"/>
<input type="button" value="-"/>	IRC	<input type="text"/>
<input type="button" value="-"/>	Other	<input type="text"/>

Available Yellow Pages settings:	
Public Server:	If you would like to make your radio station (server) public.
Stream Name:	Generally used to specify the name of the radio station or broadcast.
Stream Description:	Generally used to specify the description (or title) of the radio station or broadcast.
Stream URL:	Generally used to specify the internet address of the radio website.
Stream Genre:	Generally used to specify the genre of music or content stream by the radio station.
ICQ #, AIM:	ICQ and AIM labels. The purpose of these fields is to allow your listeners to make instant music requests or leave feedbacks on your stream. If you do not have an AIM or ICQ username, or do not wish to include it along with your stream, you should leave these fields blank.
IRC:	The field labeled 'IRC' is for those who wish to link their stream to an Internet Relay Chat server. If you do not have a chat room on an IRC server, or do not wish to include it with your stream, you should leave this field blank.
Other:	Use this type of field to send specific metadata to your server. No formatting added : your data will be inserted without processing

Dynamic metadata for Icecast/Shoutcast streaming

Dynamic metadata area also supported for Icecast/Shoutcast streams. These metadata have to be sent through a UDP port (one UDP port per metadata flow associated to an HTTP stream). UDP ports used for auxiliary data tunneling have to be declared from Preferences -> Auxiliary Data -> UDP (they must be set as input ports). For a given IP service, the source of auxiliary data can then be selected as shown in the screen capture below:

Send - Add IP Service

Name ?

Encapsulation ?

Transport protocol ?

Program

Name ?

Data tunneling:

Auxiliary data ?

Audio Stream

?

?

?

IP address ?

Port ?

File path or mount point ?

Username ?

Password ?

Buffer ?

Yellow Pages

YP Settings ?

Log traces associated to an IP service

To view the log traces associated to an IP service, click on its status LED on the right, as shown on the screen capture below.

Send - IP Services
Go to programs →

For selected service(s) or program(s) + Add IP Service

	IP Service	Program	Tunneled serial ports	Tunneled GPIs	Service Bitrate	FEC	Status
<input type="checkbox"/>	pcm241_15004				-	Yes	●
<input type="checkbox"/>	testMPTS				836 kb/s	No	●
<input type="checkbox"/>		1					●
<input type="checkbox"/>		2					●

Encapsulation = MPEG-TS SPTS

Send - Add IP Service ✕

Name ?

Synchronous AoIP None ?

Encapsulation MPEG-TS SPTS ?

Program

Name test ?

Number ?

Program PID (PMT) ?

Stream PID ?

PTS announcement period 100 ms ?

Language ENG ?

Transport Stream ID 1 ?

PCR PID ?

PSI announcement period 100 ms ?

Delay for PTS calculation 500 ms ?

Overall bitrate kbps ?

Transport protocol RTP ?

Number of TS packet per IP packet 7 ?

Audio Stream

IP address ? Port 5004 ?

Network interface / VLAN Any ?

Local source port 7004 ?

DSCP Default ?

FEC Stream MPEG (Forward error correction)

Type Column and row ?

Number of columns (L) 6 ?

Number of rows (D) 4 ?

Close Save & New Save

Program : Name	Read/Write	Select the Program to be streamed from the list of unused Programs.
Program: Number	Read/Write	Enter the program number (1 to 65535)
Program: PID (PMT)	Read/Write	Enter the Program Map Table PID (16 to 8190)
Program: Stream PID	Read/Write	Enter the PID of the elementary stream (16 to 8190)
Program: PTS announcement period	Read/Write	Enter the Program Time Stamps announcement period (from 100 to 700 ms)
Program: Language	Read/Write	Enter the language descriptor, according to ISO 639-2
Program: PCR ID	Read/Write	Program Clock Reference Select this option in case the PCR is sent as an elementary stream, and enter its packet ID (16 to 8190)

Program: PSI announcement period	Read/Write	Program Specific Information Enter the announcement period (from 100 to 5000 ms)
Program: Delay for PTS calculation	Read/Write	Enter the relative delay to be used to calculate the Presentation Time Stamp (100 to 2000ms)
Program: Overall bit rate	Read/Write	Enter the overall bit rate of the MPEG-TS stream. When set to 0, the bit rate is set automatically.
Program: Transport Protocol	Read/Write	Streaming protocol of the MPEG-TS stream: RTP or UDP.
Audio stream: IP address	Read/Write	Enter the destination IP address (unicast or multicast)
Audio stream: Port	Read/Write	Enter the destination UDP port.
Audio stream: Network interface/VLAN	Read/Write	Select the network interface or VLAN for this stream. In case the target address is unicast, select "Any" so that the Eth interface is determined automatically according to this IP address, or select a VLAN. In case the target IP address is multicast, select the Eth interface or the VLAN.
Audio stream: Local source port	Read/Write	Local UDP port number of IQOYA X/LINK
Audio stream: DSCP	Read/Write	Select the quality of service (QoS) class of the stream.
FEC stream MPEG	Read/Write	See description hereafter " FEC Pro MPEG COP#3 for MPEG-TS streams "

Click on the icon  on the bottom right of the page to add IP destinations.

Encapsulation = MPEG-TS MPTS

Send - Add IP Service
✕

Name ?

Synchronous AoIP ?

Encapsulation ?

Programs

Name ?

Number ?

Program PID (PMT) ?

Stream PID ?

PTS announcement period ms ?

Language ?

+

Transport Stream ID ?

PCR PID ?

PSI announcement period ms ?

Delay for PTS calculation ms ?

Overall bitrate kbps ?

Transport protocol ?

Number of TS packet per IP packet ?

Audio Stream

IP address ?

Network interface / VLAN ?

Local source port ?

DSCP ?

+

FEC Stream MPEG (Forward error correction)

Type ?

Number of columns (L) ?

Number of rows (D) ?

Programs : Name	Read/Write	Select the Program to be streamed from the list of unused Programs.
Programs: Number	Read/Write	Enter the program number (1 to 65535)
Programs: PID (PMT)	Read/Write	Enter the Program Map Table PID (16 to 8190)
Programs: Stream PID	Read/Write	Enter the PID of the elementary stream (16 to 8190)
Programs: PTS announcement period	Read/Write	Enter the Program Time Stamps announcement period (from 100 to 700 ms)
Programs: Language	Read/Write	Enter the language descriptor, according to ISO 639-2

An additional program to be transported in the MPTS stream can be declared by clicking on the button  right after the declared programs.

A declared program can be removed by clicking on the button  on the left of the program.

Programs: PCR ID	Read/Write	Program Clock Reference Select this option in case the PCR is sent as an elementary stream, and enter its packet ID (16 to 8190)
Programs: PSI announcement period	Read/Write	Program Specific Information Enter the announcement period (from 100 to 5000 ms)
Programs: Delay for PTS calculation	Read/Write	Enter the relative delay to be used to calculate the Presentation Time Stamp (100 to 2000ms)
Programs: Overall bit rate	Read/Write	Enter the overall bit rate of the MPEG-TS stream. When set to 0, the bit rate is set automatically.
Programs: Transport Protocol	Read/Write	Streaming protocol of the MPEG-TS stream: RTP or UDP.
Audio stream: IP address	Read/Write	Enter the destination IP address (unicast or multicast)
Audio stream: Port	Read/Write	Enter the destination UDP port.
Audio stream: Network interface/VLAN	Read/Write	Select the network interface or VLAN for this stream. In case the target address is unicast, select "Any" so that the Eth interface is determined automatically according to this IP address, or select a VLAN. In case the target IP address is multicast, select the Eth interface or the VLAN.
Audio stream: Local source port	Read/Write	Local UDP port number of IQOYA X/LINK
Audio stream: DSCP	Read/Write	Select the quality of service (QoS) class of the stream.
FEC stream MPEG	Read/Write	See description hereafter " FEC Pro MPEG COP#3 for MPEG-TS streams "

Click on the icon  on the bottom right of the page to add an IP destination.

FEC stream MPEG

This section allows configuring a Pro MPEG COP#3.2 FEC for the MPEG-TS stream.

Type	<p>No Redundancy: No FEC is generated.</p> <p>Column: 1 dimension FEC scheme. Only FEC frames generated from columns are streamed. Number of columns can be set from 1 to 20. This FEC is ideal for</p>
------	---

	<p>correcting packet burst errors and random errors. The column FEC frames are sent to UDP port = MPEG-TS stream UDP port + 2.</p> <p>Column and row: 2 dimensions FEC scheme. Provides correction for non-consecutive lost frames, and can correct any single packet loss within a row of media packets.</p> <ul style="list-style-type: none"> • $4 \leq \text{Number of Columns (L)} \leq 20$. • $4 \leq \text{Number of rows (D)} \leq 20$ • $L \times D \leq 100$ <p>The column FEC frames are sent to UDP port = MPEG-TS stream UDP port + 2. The row FEC frames are sent to UDP port = MPEG-TS stream UDP port + 4.</p>
Number of columns (L)	<p>Column depth</p> <p>Column scheme: value from 1 to 20</p> <p>Column and row scheme: $4 \leq L \leq 20$</p>
Number of rows (D)	<p>Row depth: $4 \leq \text{Number of rows (D)} \leq 20$</p>

Click on “Save” to confirm the settings. Click on “Save & New” to confirm the settings and create a new IP service with the same parameters.

Click on “Close” to discard the settings.

8.1.4 “Receive” category of menus

This category allows defining the IP services to be received by IQOYA, and the audio programs to be played to the outputs of IQOYA; three decoding priorities can be defined per audio program.

8.1.4.1 Receive -> IP services

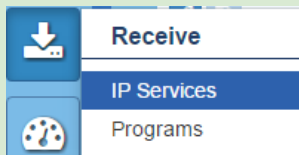

This page allows declaring and viewing the IP services to be received by IQOYA.





The screenshot shows the 'Receive - IP Services' interface. It features a sidebar with navigation icons (Home, Settings, Refresh, Upload) and a main content area. The main area has a title 'Receive - IP Services' and a 'Go to programs' button. Below the title, there is a 'Delete selected IP service(s)' button and an '+ Add IP Service' button. A table lists the IP services:

<input type="checkbox"/>	Name	URL	Encapsulation	FEC
<input type="checkbox"/>	5004	rtp://127.0.0.1:5004	None	No
<input type="checkbox"/>	shoutcast	http://tonicradiobourgoin.ice.infomaniak.ch:80/tonicradiobourgoin.mp3	None	No

In case some IP Services are already created, they are listed in the IP Services page, with their characteristics: : name, URL, encapsulation (MPEG-TS or not), FEC.

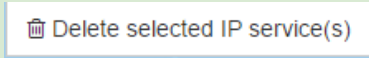
To edit an existing IP service, click on the icon  on the right end of its line.

To remove an IP service, click on the icon  on the left end of its line, and select .

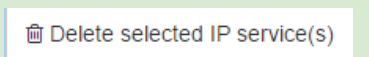
To delete all the IP services, click on the icon  on the left of "Name", and select .

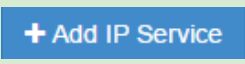
To declare a new IP service, click on the button .

An IP service can also be created by duplicating an existing one. Click on the icon  on the left on the IP service to be duplicated.

When declaring or editing an IP service the following page is displayed.

Receive - Add IP Service
×

IP Service name	<input type="text"/>	?
Synchronous AoIP	<input type="text" value="None"/>	?
Transport protocol	<input type="text" value="RTP"/>	?
Encapsulation	<input type="text" value="None"/>	?

Audio stream

IP address	<input type="text" value="127.0.0.1"/>	?
Listening port	<input type="text" value="5004"/>	?
Jitter	<input type="text" value="200"/> ms	?
Loss	<input type="text" value="150"/> ms	?
Synchro clock	<input type="text" value="None"/>	?
In-band format signalling	<input type="text" value="No"/>	?
Payload type	<input type="text" value="96"/>	?

FEC stream

Type	<input type="text" value="No redundancy"/>	?
------	--	---

In case Icecast/Shoutcast is selected for the transport protocol (for WEB radio), the following parameters are displayed.

Receive - Add IP Service
✕

IP Service name ?

Transport protocol ShoutCast/Icecast ▼ ?

Audio stream

URL ?

Listening port 80 ?

File path or mount point ?

Buffer 10 s ?

Close
Save & New
Save

Parameter	Type	Description
IP service name	Read/Write	Name given to this IP service. This is the name that can be selected in the source of a decoding priority of an output program.
Transport protocol	Read/Write	Values: RTP, UDP, Icecast/Shoutcast
Encapsulation	Read/Write	Only displayed if selected transport protocol is different from Icecast/Shoutcast. Values are: None, MPEG-TS SPTS or MPEG-TS MPTS.
Audio stream: IP address (for RTP and UDP)	Read/Write	In unicast, set this parameter to 127.0.0.1, otherwise enter the multicast IP address to listen to.
Audio stream: listening port (for RTP and UDP)	Read/Write	For RTP and UDP protocols, value of the UDP port to listen to. For Icecast/Shoutcast, value of the TCP port to listen to.
Audio stream: Jitter (for RTP and UDP)	Read/Write	Enter the input buffering size to compensate the jitter of the network. This value, expressed in ms, must be at least equal to the measured jitter. In case there is FEC, it is necessary to consider the measured jitter for "primary and FEC stream".
Audio stream: Loss (only for RTP)	Read/Write	Defines the duration of consecutive lost packets until which IQOYA replaces lost frames by silence, without flushing the buffer of jitter. If the absence of received consecutive packets exceeds this duration, the buffer of jitter is then flushed, and filled again with received packets; this allows resynchronization on the incoming IP audio stream, but this generates a silence longer than the consecutive packet lost. To avoid long audio silences when only a few consecutive packets are lost (especially for high jitter values), it is recommended to set the Loss value to approximately 3/4 of the jitter buffer.
Audio stream: Synchro clock (for RTP)	Read/Write	Select NTP in case the audio synchronization on NTP is used for decoding this stream (optional feature).
Audio stream: In-band format signalling (for RTP)	Read/Write	Set this parameter to "Yes" if it is also set to "Yes" on the IQOYA encoder.

		Set this parameter to “No” if it is not configured on the IQOYA encoder, or if the encoder is another brand.
Audio stream: payload type (for RTP)	Read/Write	Only displayed if “In-band format signalling” is set to “No”. Enter the payload value of the audio stream (same payload value as configured on the stream encoder).
Audio stream: URL (for HTTP)	Read/Write	Only displayed when Transport Protocol is set to Icecast/Shoutcast URL of the Icecast/Shoutcast server. Example: streamer.mysite.com.
Audio stream: File path or mount point (for HTTP)	Read/Write	File path of the source of a Shoutcast server. File path of the source or mount point of an Icecast server.
Audio stream: Buffer (for HTTP)	Read/Write	Buffer value in seconds necessary to decode correctly the HTTP stream. This value may depend on the HTTP server. In case the decoding is producing audio breaks, this value has to be increased.

In case the audio format of the IP stream is not signalled in-band, it is necessary to declare if the received IP service includes an FEC.

Select the appropriate FEC for the Type field as shown below. The payload type is set automatically.

FEC stream

Type: "+50% bandwidth, recovery" ?

Payload type: 98 ?

Advanced mode: No ?

Close Save

In case FEC is not sent on the default UDP port and IP address, select “Yes” in the “ Advanced mode” field, to be able to enter the IP address and UDP port.

FEC stream

Type: "+50% bandwidth, recovery" ?

Payload type: 98 ?

Advanced mode: Yes ?

IP address: ?

Listening port: 5004 ?

Close Save

FEC stream parameters	Type	Description
Type	Read/Write	Select the FEC that is configured on the encoder of the received IP stream.
Payload type	Read/Write	Enter the same FEC payload type that is configured on the encoder of the received IP stream.



Advanced mode	Read/Write	Select “Yes” if the FEC destination IP address is not the same as the IP stream destination IP address, or of it is to be received on a UDP port different from “IP stream UDP port +2”
IP address	Read/Write	Displayed if Advanced mode is set to “Yes”. In unicast, set the IP address to 127.0.0.1. In multicast, enter the multicast IP address.
Listening port	Read/Write	Displayed if Advanced mode is set to “Yes”. Enter the UDP port for receiving the FEC.

Click on “Save” to confirm the settings.

8.1.4.2 Receive -> Programs

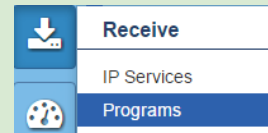

Output programs are composed of a list of audio sources organized in priorities. Up to 3 decoding priorities can be defined. The highest priority is priority 1. If the audio source of priority 1 is lost, IQOYA switches to priority 2 if the corresponding audio source is available, or to priority 3 if the corresponding audio source is available. If no declared audio source is available, the program output is silent.

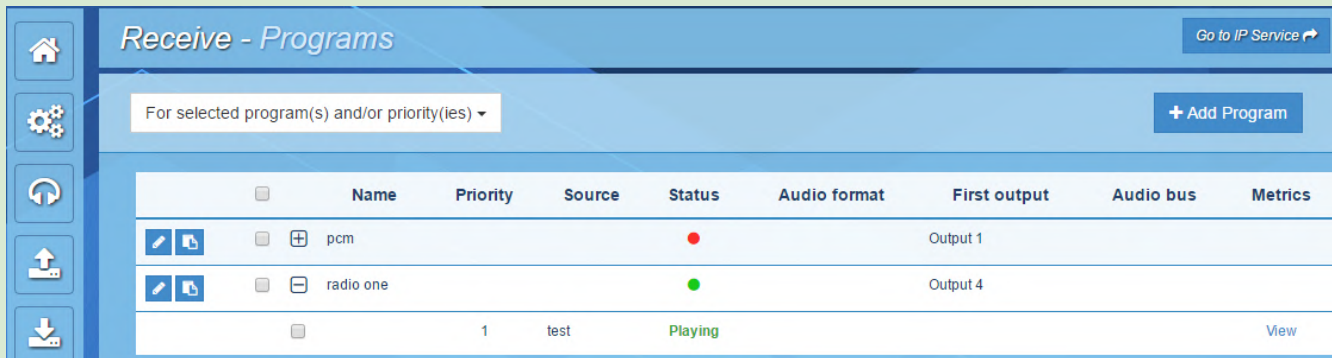

Output programs configuration is accessible either from the left column , or directly from the icon “Go to IP Service” on the top right of the IP Services .



The “Programs” page displays the declared output programs.

To declare a new output program, click on , or create it from an existing one by selecting the icon  on the left of this latter.

Receive - Edit Program
✕

Program Backup switching

Program name

?

Disabled

?

Audio outputs

Primary output

First output type ?

First output ?

Number of outputs ?

Secondary output

First audio bus ?

Priority 1

Source Silence detection

Type

?

First input

?

Disabled

?

Digital level (dB)

?

+

Close Save

Program Parameter	Type	Description
Program name	Read/Write	Name given to this output Program.
Disabled	Read/Write	Set this parameter to “Yes” if you want to disable the program. This means that IQOYA does not process it. Set this parameter to “No” so that IQOYA processes this program and decodes audio.
Audio outputs: first output type	Read/Write	Audio I/O: to select a physical output (not available on X/LINK-AES67) AoIP: to select a declared output stream (AES67/RAVENNA/Livewire) Audio Bus: to select an audio bus (optional)
Audio outputs: first output	Read/Write	Select the first audio output associated to this program. Note that it is necessary to select an audio output that is not assigned to another program (an error is displayed)
Audio outputs: First audio bus	Read/Write	Select the first audio bus channel associated to this program. Audio bus is useful for IP stream transcoding.
Number of outputs	Read/Write	Set this parameter to 1 for mono, 2 for stereo, 6 for 5.1, 8 for 7.1.

Backup switching criteria

Receive - Edit Program
✕

Program

Backup switching

IP stream loss duration	1000	ms	?
IP stream recovery duration	1000	ms	?
IP stream absence duration	500	ms	?

Close

Save

Program Parameter	Description
<i>IP stream loss duration</i>	In case the codec is configured to decode an IP audio stream and at least one backup is defined, you can configure the backup switching criteria. IP stream loss duration , expressed in ms, is the duration of absence of the stream. When this condition is encountered on priority 1 or priority 2, IQOYA automatically switches to the lower priority. The minimum value for this duration is the jitter value set from the Receive page.
<i>IP stream recovery duration</i>	This value, expressed in ms, is the duration of presence of the stream after it has been lost. When this condition is encountered, IQOYA automatically switches to the higher priority where the stream is recovered. These two criteria apply to the main received IP stream as well as to the backup IP stream.
<i>IP stream absence duration</i>	During the stream recovery process, if a received packet is followed by a packets absence duration larger than this “IP stream absence duration”, the stream is considered as absent. This value (in ms) should be lower than half the “IP stream recovery duration”. If the value is set to 0, this parameter is ignored..

The following parameter define the audio source associated to priority 1. It is possible to declare two additional priorities by clicking on the button  on the right below the decoding priority.

The parameters listed for a decoding priority depend on the selected source “Type”: IP service, File, Playlist, Audio input.

Source Type = IP service, and IP service is RTP

Priority 1

Source Silence detection

Type IP Service ?

Service FLUX02 ?

Received format auto-detection Yes ?

Disabled No ?

Digital level (dB) 0 ?

Input channel mapping ?

PLL Yes ?

Data tunneling:

Auxiliary data None ?

Routing of tunneled GPIs:

[1-4] : Physical GPIs

	GPI index	GPO	Inversion	?
[-]	Tunneled GPI 1	<input type="text" value="1"/>	<input type="checkbox"/>	
[-]	Tunneled GPI 2	<input type="text" value="2"/>	<input type="checkbox"/>	

+

Priority Source Parameter	Type	Description
Type	Read/Write	Select the audio source for this priority. IP Service: audio will be extracted from a declared IP service. File: audio source is a local file Playlist: audio source is a local “m3u” playlist Audio input: audio source is an audio input.
Service	Read/Write	Select the IP service from the list of declared IP services. (IP services must have been declared first from the IP Services page).
Received format auto-detection	Read	This parameter is set automatically according to the selected IP service. If the IP service has been declared with in-band format signalling, auto-detection is set to “Yes”.
Disabled	Read/Write	Set this parameter to “Yes” to disable this decoding priority. Disabling a define priority is useful when some servicing is in progress on it (network servicing, servicing on the source of the IP stream). The priority can then be enabled when servicing operations are finished.
Digital Level (dB)	Read/Write	Digital gain applied to the audio samples on this priority.
Input channel mapping	Read/Write	Displayed when the audio source includes more audio channels than the output. Select how the channels of the selected source are to be processed: <ul style="list-style-type: none"> No: each input channel is assigned to an output channel. Mix: the input channels are mixed to a single output channel. An attenuation of -6 dB is applied to each channel before they are mixed. The gain/attenuation set through “Digital level” comes in addition to this attenuation.

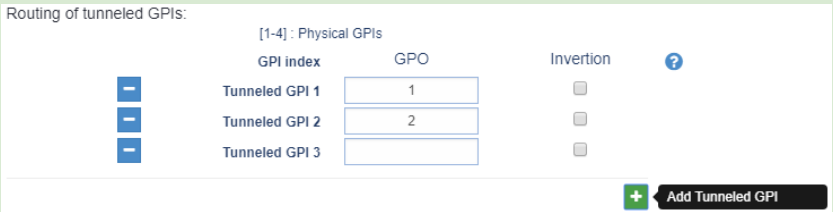
		<ul style="list-style-type: none"> • First channel only: only the first channel is processed. • Second channel only: only the second channel is processed.
PLL	Read/Write	<p>To be set to “Yes” in most of the use cases. It allows synchronisation of the incoming stream to the internal clock, thus guaranteeing a constant latency with the encoder.</p> <p>Has to be set to “No” typically when AES transparency is required between the encoder and the decoder (this requires also that the encoder and the decoder use clocks that have the same frequency).</p>
Data tunneling: Auxiliary data	Read/Write	In case serial data are tunneled in-band, select the output port. It can be the RS232 COM port, or a UDP port if it has been declared from menu “Preferences/Auxiliary data/UDP”.
Routing of tunneled status data: Status data indexes	Read/Write	 <p>Enter the GPO number (starting from 1) that will reflect the tunneled GPI status. Click on “Add tunneled GPI” to route another tunneled status.</p>
Routing of tunneled status data: GPO inversion mask	Read/Write	Check the box under a GPO so that it reflects the inverted status of the tunneled GPI.

Silence detection parameters for the decoding priority

Priority 1

Source: Silence detection

Disable upon silence detection: Yes No

Input signal for silence detection: Mean of left + right channels

Silence threshold: -43.00 dB

Silence duration: 1000 ms

Signal threshold: -43.00 dB

Signal duration: 2000 ms

Signal drop duration: 1000 ms

Priority Source Parameter		Type
<i>Disable upon silence detection</i>	Read/Write	IQOYA can also automatically disable the decoding priority in case of silence detection in the audio source. The priority can then be enabled again via the WEB site, or via SNMP.
<i>Input signal for silence detection</i>	Read/Write	<p>The parameter “Input signal for silence detection” allows defining on which source signal the silence detection is applied. Possible choices are:</p> <ul style="list-style-type: none"> - Mean of left + right channels: compares the mean value of a left and right sample to the threshold. In case the calculated values are always lower to the silence threshold during the defined silence duration, silence condition is reached. - Left channel only: compares the left channel samples to the silence threshold. In case the sample values are always lower to the silence threshold during the defined silence duration, silence condition is reached. - Right channel only: compares the right channel samples to the silence threshold. In case the sample values are always lower to the silence threshold during the defined silence duration, silence condition is reached. - Left and right channels: compares both the left and right channel samples to the silence threshold. In case the sample values on both channels are always lower to the silence threshold during the defined silence duration, silence condition is reached. - At least one channel: compares both the left and right channel samples to the silence threshold. In case the sample values on at least one on the two channels are always lower to the silence threshold during the defined silence duration, silence condition is reached.
<i>Silence threshold & Silence duration</i>	Read/Write	<p>Silent audio is defined through these two parameters, expressed in dBfs.</p> <p>When audio level is below the threshold value during at least the defined duration, the alarm “Analog audio in silent” or “Digital audio in silent” is set (if it is enabled from the “Alarms setup” menu).</p>
<i>Signal threshold Signal duration Signal drop duration</i>	Read/Write	<p>Audio signal is defined through the three parameters. Audio signal is considered as recovered if all the following conditions are true:</p> <ul style="list-style-type: none"> • Audio level exceeds the Signal threshold (dBfs) within the “Signal duration” analysis window (ms). • Audio level does not stay below the Signal threshold during the “Signal drop duration”, within the “Signal duration” analysis window. <p>Note the following rule: Signal drop duration \leq (Signal duration / 2). Once signal is recovered, the alarm “Analog audio in silent” or “Digital audio in silent” is reset (if it is enabled from the “Alarms setup” menu).</p>

Source Type = IP service, and IP service is UDP

Source [Silence detection](#)

Type	IP Service	?
Service	test5	?
Mode	Stereo	?
Sample rate	48000Hz	?
Encoding format	AAC-LC	?
Bit rate	288kb/s	?
Disabled	No	?
Digital level (dB)	0 	?
Input channel mapping	No	?
PLL	Yes	?

Data tunneling: 

[Close](#) [Save & New](#) [Save](#)

In UDP mode, the audio format has to be declared.

Source Type = IP service, and IP is a WEB radio

Priority 1

Source [Silence detection](#)

Type	IP Service	?
Service	WEB radio	?
Disabled	No	?
Digital level (dB)	0 	?
Input channel mapping	No	?
PLL	Yes	?

Data tunneling:

Auxiliary data	None	?
----------------	------	---



[Close](#) [Save & New](#) [Save](#)

Parameter	Type	Description
Type	Read/Write	IP Service
Service	Read/Write	Select the IP service from the list of declared IP services. (IP services must have been declared first from the IP Services page).
Disabled	Read/Write	Set this parameter to “Yes” to disable this decoding priority.
Digital Level (dB)	Read/Write	Digital gain applied to the audio samples on this priority.
Input channel mapping	Read/Write	Select how the channels of the selected source are processed: <ul style="list-style-type: none"> • No: each input channel is assigned to an output channel. • Mix: the input channels are mixed to a single output channel. An attenuation of -6 dB is applied to each channel before they are mixed. The gain/attenuation set through “Digital level” comes in addition to this attenuation. • First channel only: only the first channel is processed. • Second channel only: only the second channel is processed.
PLL	Read/Write	Set to Yes in most of the cases. It allows synchronization of the incoming IP audio to the sampling clock, thus guaranteeing a constant delay. It has to be set to No when samples must ne be modified between the encoder and the decoder (this required that the encoder and the decoder have clock sources having the exact same sampling frequency)
Data tunneling: Auxiliary data	Read/Write	In case serial data are tunneled in-band, select the output port. It can be the RS232 COM port, or a UDP port if it has been declared from menu “Preferences/Auxiliary data/UDP”.

Source Type = File or Playlist

Source Silence detection

Type ?

Playlist file ?

Disabled ?

Digital level (dB) ? 

Input channel mapping ?

+

Parameter	Type	Description
Type	Read/Write	File or Playlist. These files are stored locally on the internal DOM (disk on module).

Audio File	Read/Write	Select the an audio file or playlist from the list.
Disabled	Read/Write	Set this parameter to “Yes” to disable this decoding priority.
Digital Level (dB)	Read/Write	Digital gain applied to the audio samples on this priority.
Input channel mapping	Read/Write	Select how the channels of the selected source are processed: <ul style="list-style-type: none"> No: each input channel is assigned to an output channel. Mix: the input channels are mixed to a single output channel. An attenuation of -6 dB is applied to each channel before they are mixed. The gain/attenuation set through “Digital level” comes in addition to this attenuation. First channel only: only the first channel is processed. Second channel only: only the second channel is processed.

Source Type = Audio input

Priority 1

Source [Silence detection](#)

Type ?

First input

Disabled ?

Digital level (dB)  ?

Input channel mapping ?

[+](#)

[Close](#) [Save](#)

Parameters are the same as above, except the audio input that must be selected instead of a sound file or playlist.

Once output programs have been defined, they are listed in the “Programs” page.

To view the content of a program, click on  on the left of its name.

Receive - Programs [Go to IP Service](#)

For selected program(s) and/or priority(ies) [+ Add Program](#)

<input type="checkbox"/>	Name	Priority	Source	Status	Audio format	First output	Audio bus	Metrics
<input type="checkbox"/>	pcm			●		Output 1		
<input type="checkbox"/>	radio one			●		Output 4		
<input type="checkbox"/>		1	test	Playing				View
<input type="checkbox"/>		2	File Contigo.wav	Available				

The decoding priorities of the program are displayed as well as some associated information:

- Name: program name
- Priority: 1, 2, or 3 priorities are displayed, depending on what has been defined.
- Source: displays the name of the audio source defined for the priority
- Program status: Displays the status of the program, and the status of each priority.
Possible program statuses are:
 - Green LED => the first enabled priority is decoded.
 - Orange LED => the source of a priority is missing
 - Red LED => all the defined sources are missing.Possible priority statuses are:
 - **Playing**: IQOYA is playing this priority
 - **Missing**: the audio source of the priority is missing
 - **Disable**: the decoding priority is disabled
 - **Available**: means that the source of this priority is detected, but a higher priority source is being played.
- Audio format: display the audio format of the decoded IP service.
- First output: displays the first output used for the program
- Serial: displays the serial port that outputs tunneled serial data.
- GPOs: displays the GPO that reflect the tunneled statuses

- Metrics/view: Click on [view](#) to display the metrics of the IP service.

Program's Metrics
✕

Reset IP metrics Reset

Max measured jitter (Primary & FEC) 46 ms

Primary stream (127.0.0.1:5012)

Measured jitter 3 ms

Received packets 13970

Lost packets 0

Late packets 0

Duplicated packets 0

Reordered packets 0

Recovered packets 0

Forward error correction stream (127.0.0.1:5014)

Measured jitter 1 ms

Received packets 4656

Lost packets 0

Late packets 0

Duplicated packets 0

Reordered packets 0

Jitter distribution Primary stream

[0.0 - 6.0[99.98%	13967/13970 packets
[6.0 - 12.0[0%	0/13970 packets
[12.0 - 18.0[0%	0/13970 packets
[18.0 - 24.0[0%	0/13970 packets
[24.0 - 30.0[0%	0/13970 packets
[30.0 - 36.0[0%	0/13970 packets
[36.0 - 42.0[0%	0/13970 packets
[42.0 - 48.0[0%	0/13970 packets

Close

These metrics are important characteristics of the network path. In case an FEC is used, metrics are available for both the primary stream and the FEC stream.

Note that the measured jitter (Primary + FEC streams)

Variable	Meaning
Max Measured jitter	Displayed only if an FEC stream is received. Defines the minimum jitter to be configured in Receive->IP Services (it includes the primary stream and the FEC stream). On unmanaged networks, we recommend to configure a higher value as the jitter may evolve and reach higher values.
Measured jitter	Jitter measured for the considered stream (primary or FEC). If no FEC stream is received, this value defines the minimum jitter to be configured

	in Receive->IP Services (it includes the primary stream and the FEC stream). On unmanaged networks, we recommend to configure a higher value as the jitter may evolve and reach higher values.
Receive packets	Number of IP frames received for the considered stream (primary or FEC). If this value does not increase regularly, the IP stream is not received.
Lost packets	Number of IP frames that have not been received.
Late packets	Number of IP frames that have been received late.
Duplicated packets	Number of IP frames that are received more than once. IQOYA automatically removes duplicated frames.
Reordered packets	Number of IP frames that have been reordered after being received disordered.
Recovered packets	Number of IP frames that are recovered thanks to the FEC. If "Lost packets - Recovered packets" equals 0, the FEC is adapted to the network path. If "Lost packets > Recovered packets", the selected FEC does not allow to recover all the lost packets. It is then necessary to select another FEC. Make also sure that the jitter value set in Receive-> IP services is higher than the max measured jitter.

8.1.5 Status

The status page displays a synthesis of the statuses of sent IP Services and output programs, and gives access to all the alarms of each IP service and output program.



This page is accessible by clicking on the icon .

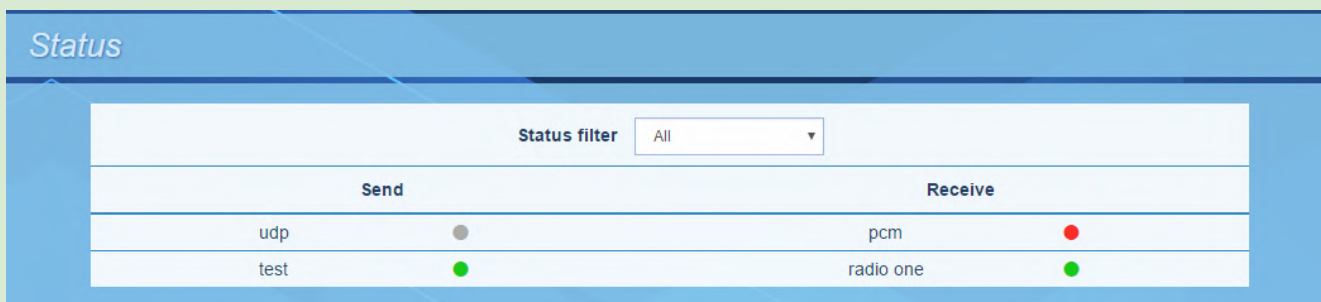

All sent IP services are listed on the left under "Send".

All output programs are listed on the right under "Receive".





The parameter "Status filter" allows filtering on the type of alarms to take into account for the display. Possible values are:

- All: all alarms are taken into account.
Green LED means no alarm is ON.
Orange LED means there are warnings ON.
Red LED means there are alarms and the stream is stopped.
- Warnings: only the warnings are taken into account. They concern the receivers.
- Failures: only failures are taken into account; this is typically when there is a streaming failure (no stream received, no stream sent).

A list of all the alarms can be displayed by click on the IP Service name (Send), and on the output program name (Receive).

8.2 WEB pages organization in “Remote Broadcasting” mode of use

The WEB pages are organized in categories which are always accessible from the left side of the WEB pages.

Icon	Category	Description
	Operations (Home page)	Displays the mosaic of call pages of the different active codec instances.
	Connections	Connection parameters of the unit and of the codec instances: <ul style="list-style-type: none"> - at network level - ethernet and IP - at audio and SIP level - at user level - contacts and call profiles.
	Advanced Settings	System parameters (System properties, clock settings, audio advanced settings, alarm settings, logs, configuration up- and download, firmware and license update, password change, shutdown/restart, mode of use switch). Secondary network service settings (NTP, FTP, SSH). Auxiliary data settings (from/to serial ports, GPIO or UDP sockets).
	Audio I/Os	Audio input and audio output settings: name, type selection, audio level adjustment, vu-meters
	Help	About IQOYA X/LINK and this user manual.

All the web pages has the same header showing the following information:

- On the left, the status of the redundant power supply unit:

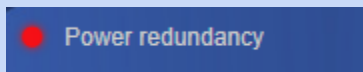



The led is green when the two redundant power supplies work correctly,
 The led is red when one of the two redundant power supplies is out of order.
 The redundant power supplies are hot swappable.

- On the right, the device model and the current mode of use:



8.2.1 “Operations” page

This page presents the call windows of the codec instances currently configured and enabled. Each call window can be expanded clicking on  or collapsed clicking on 

In the example below, the call window of the first IP codec instance is expanded while the call window of the second codec instance is collapsed:

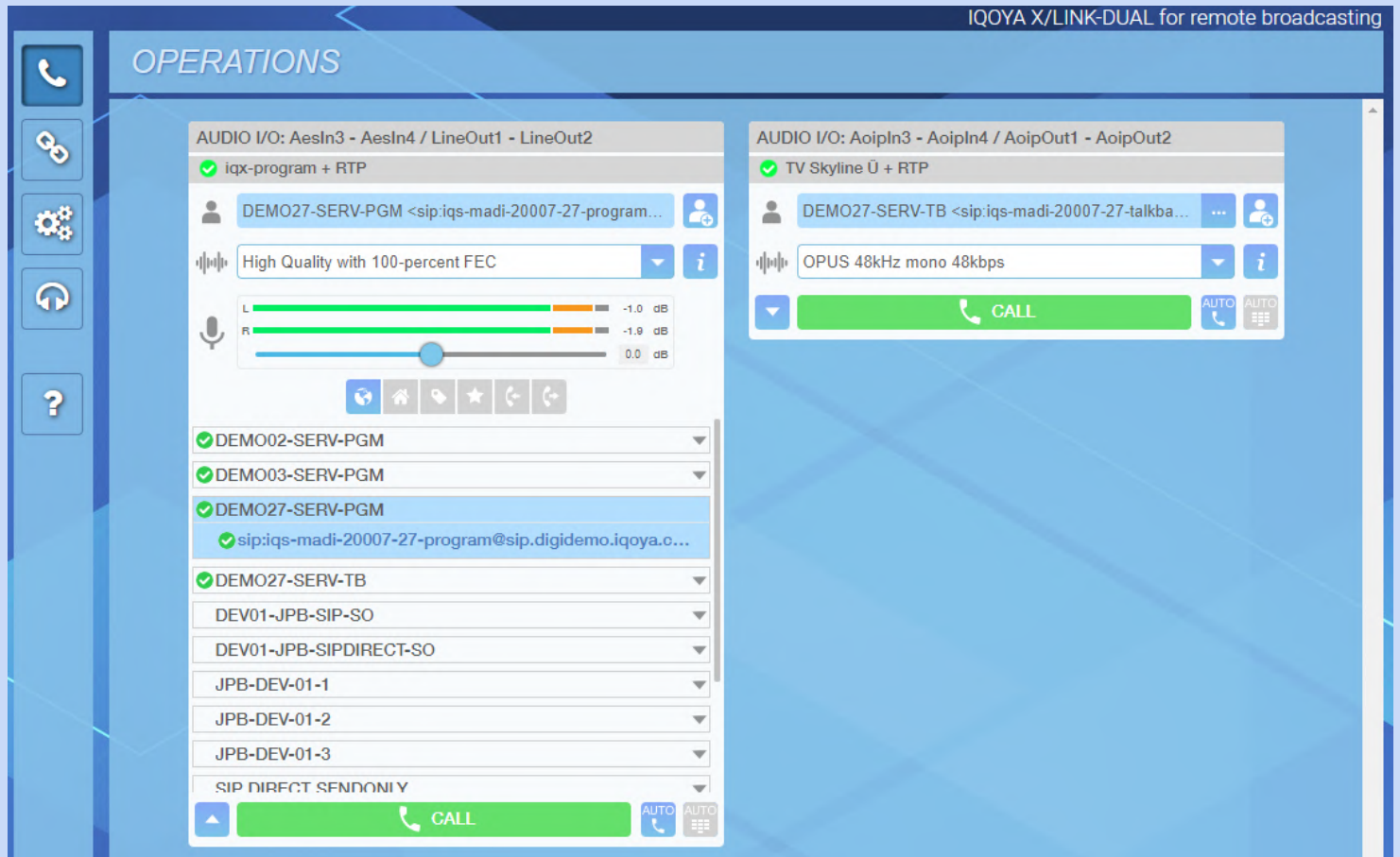

Each call window can be reopened in an independent window by double clicking on its title bar.

8.2.1.1 Call window when no communication is in progress

Call window (expanded version):

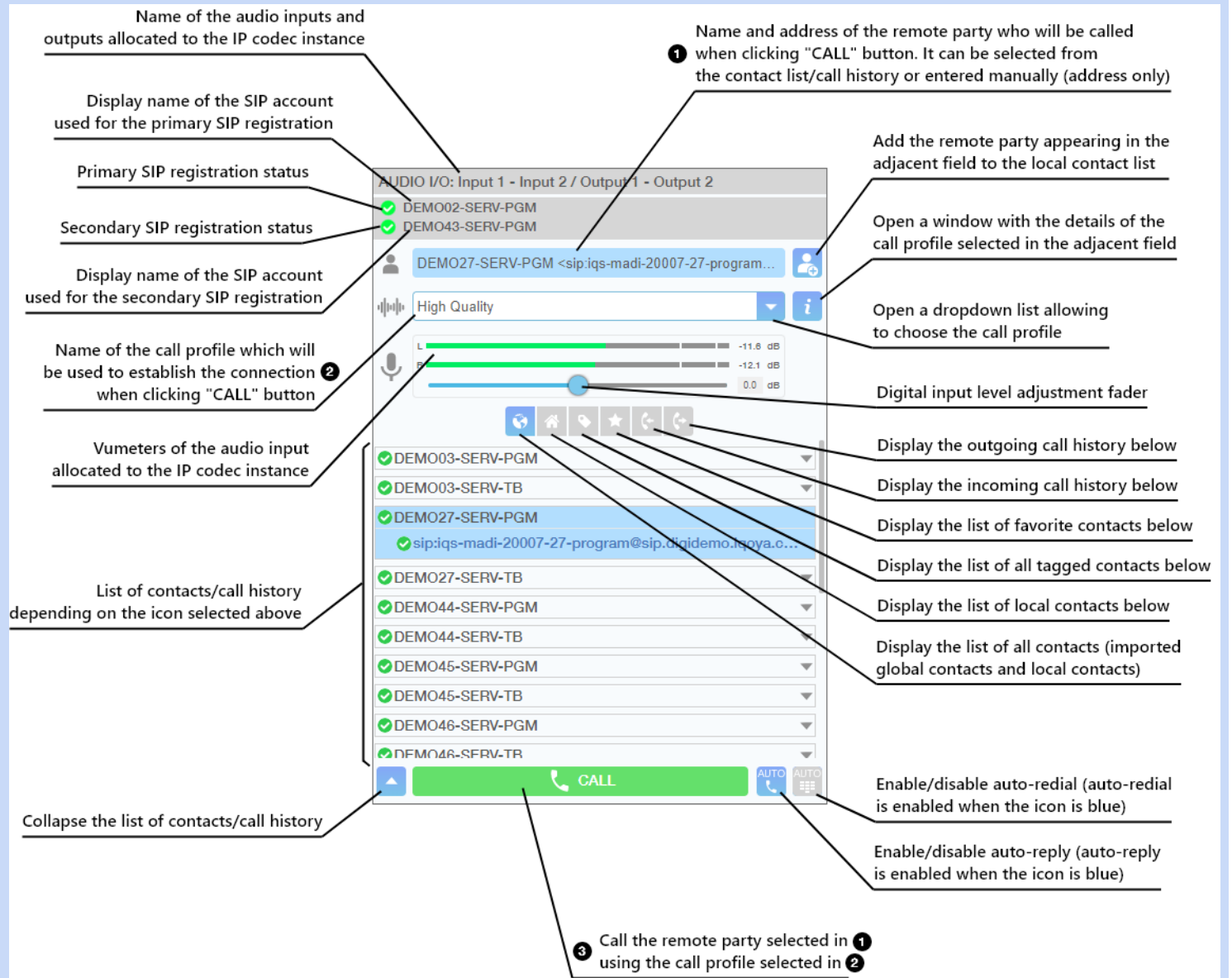

The screenshot shows the call window interface with the following components and labels:

- 1** Name and address of the remote party who will be called when clicking "CALL" button. It can be selected from the contact list/call history or entered manually (address only)
- 2 Name of the call profile which will be used to establish the connection when clicking "CALL" button
- 3 Call the remote party selected in 1 using the call profile selected in 2
- Name of the audio inputs and outputs allocated to the IP codec instance
- Display name of the SIP account used for the primary SIP registration
- Primary SIP registration status
- Secondary SIP registration status
- Display name of the SIP account used for the secondary SIP registration
- Vumeters of the audio input allocated to the IP codec instance
- List of contacts/call history depending on the icon selected above
- Collapse the list of contacts/call history
- High Quality
- Digital input level adjustment fader
- Display the outgoing call history below
- Display the incoming call history below
- Display the list of favorite contacts below
- Display the list of all tagged contacts below
- Display the list of local contacts below
- Display the list of all contacts (imported global contacts and local contacts)
- Enable/disable auto-redial (auto-redial is enabled when the icon is blue)
- Enable/disable auto-reply (auto-reply is enabled when the icon is blue)
- Add the remote party appearing in the adjacent field to the local contact list
- Open a window with the details of the call profile selected in the adjacent field
- Open a dropdown list allowing to choose the call profile

Call window (collapsed version):

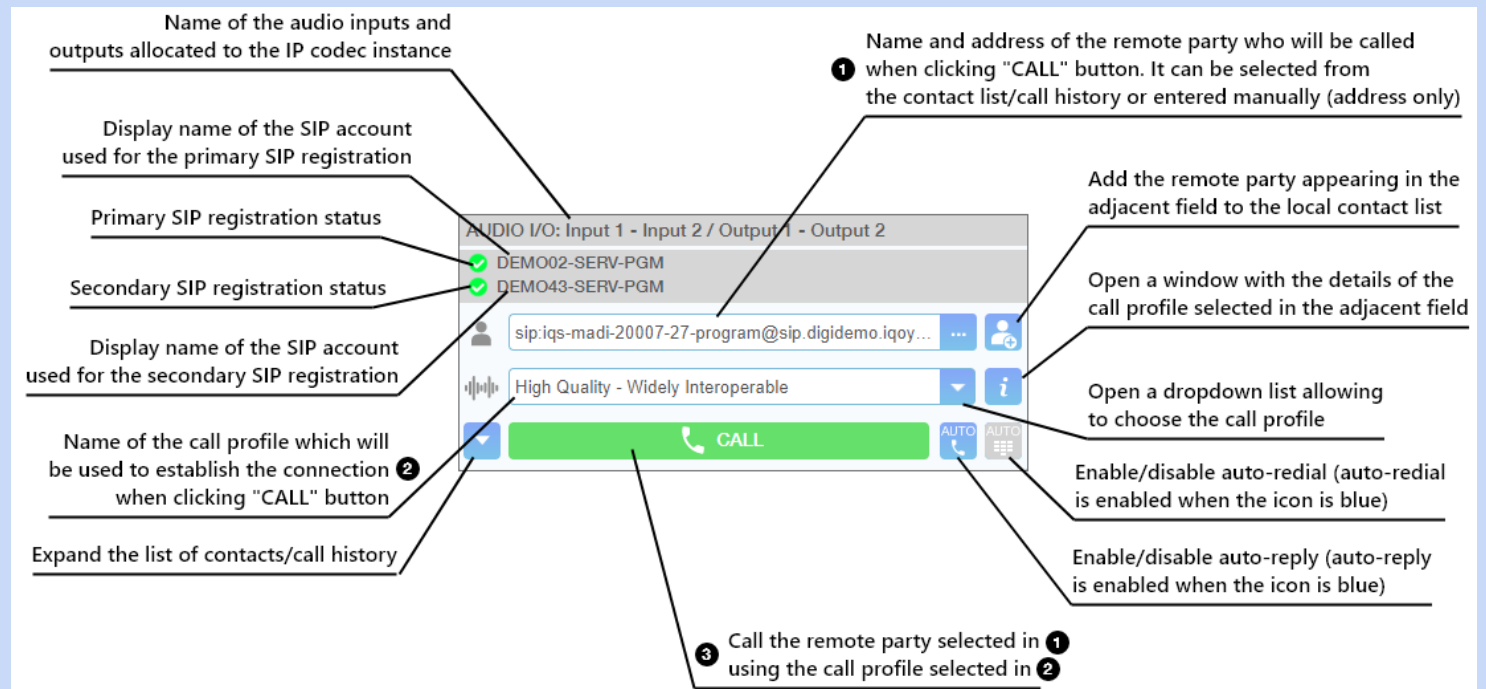

The screenshot shows a call window interface with the following annotated components:

- 1** Name and address of the remote party who will be called when clicking "CALL" button. It can be selected from the contact list/call history or entered manually (address only)
- 2** Name of the call profile which will be used to establish the connection when clicking "CALL" button
- 3** Call the remote party selected in **1** using the call profile selected in **2**
- Display name of the SIP account used for the primary SIP registration
- Primary SIP registration status
- Secondary SIP registration status
- Display name of the SIP account used for the secondary SIP registration
- Name of the audio inputs and outputs allocated to the IP codec instance
- High Quality - Widely Interoperable
- CALL button
- AUTO (auto-redial) button
- AUTO (auto-reply) button
- Expand the list of contacts/call history
- Add the remote party appearing in the adjacent field to the local contact list
- Open a window with the details of the call profile selected in the adjacent field
- Open a dropdown list allowing to choose the call profile
- Enable/disable auto-redial (auto-redial is enabled when the icon is blue)
- Enable/disable auto-reply (auto-reply is enabled when the icon is blue)

8.2.1.2 Place a call

Please refer to the image of the previous paragraph for references to the graphical interface.

To place a call the user (1) select a remote party in the contact list/call history or enter the remote party address, (2) select a call profile and (3) press the CALL button. The CALL button is grayed out until the remote party and the profiles have been specified.

Format of the remote party address

- For a SIP connection, the address is:

```

sip:sip_account_name@sip_server_domain:sip_server_port
      
```

 (the *sip_server_port* is optional, 5060 is used as default).
 The "sip:" prefix must not be forgotten when the SIP address is entered manually.
- For a direct SIP connection, the address is:

```

sip:@remote_party_IP_address:remote_party_SIP_listening_port
      
```

 (the *remote_party_SIP_listening_port* is optional, 5060 is used as default)
- For a symmetric RTP connection, the address is:

```

remote_party_IP_address:remote_party_audio_listening_port
      
```

8.2.1.3 Accept or reject a call

Click ACCEPT button to accept an incoming call or DECLINE button to reject it:

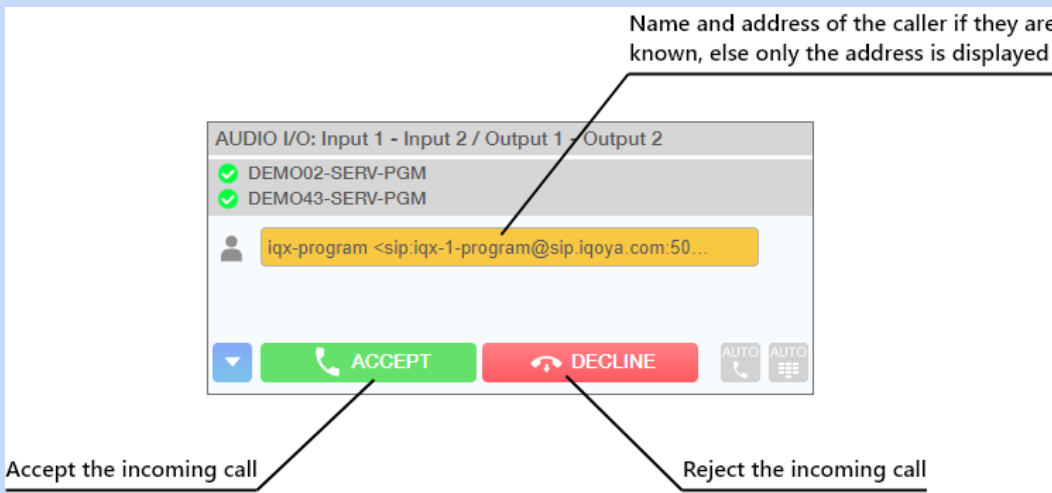

8.2.1.5 Call window when a communication is in progress

Call window (expanded version with network quality selector in QUALITY position):

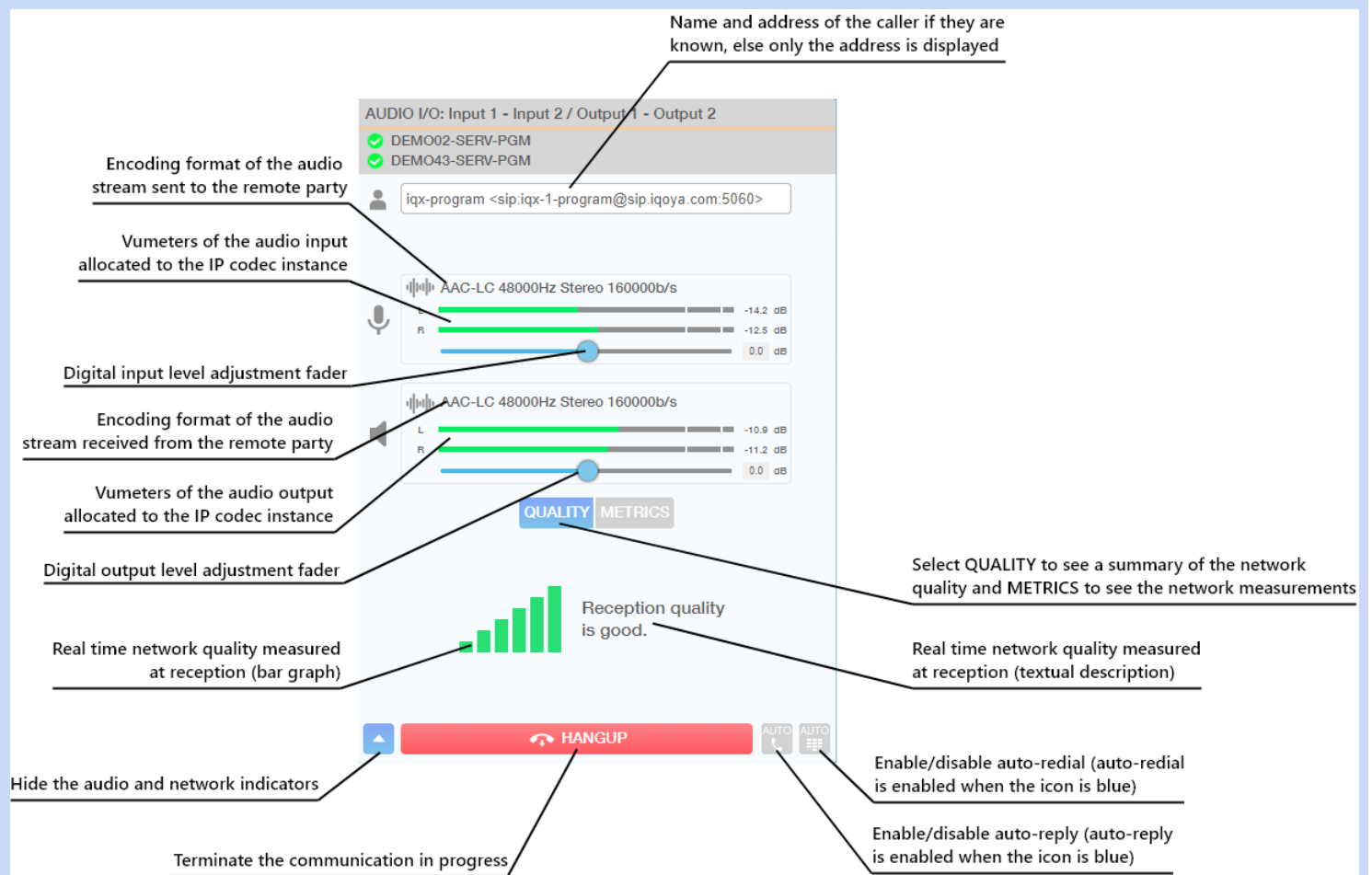

Call window (expanded version with network quality selector in METRICS position):

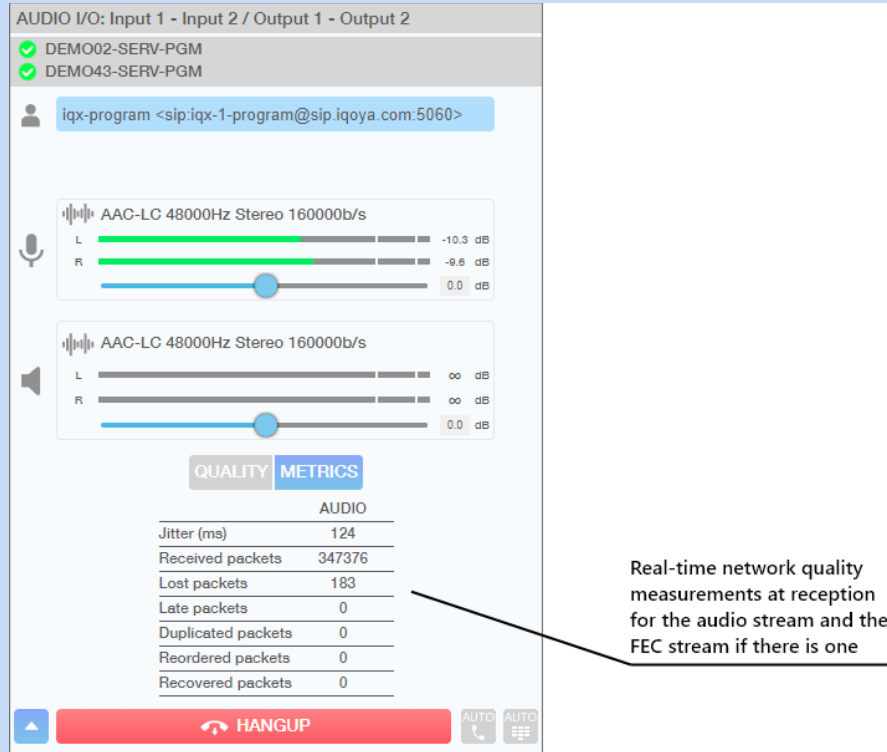

AUDIO I/O: Input 1 - Input 2 / Output 1 - Output 2

DEMO02-SERV-PGM
 DEMO43-SERV-PGM

iqx-program <sip:ixq-1-program@sip.iqoya.com:5060>

AAC-LC 48000Hz Stereo 160000b/s
 L: -10.3 dB
 R: -9.8 dB
 0.0 dB

AAC-LC 48000Hz Stereo 160000b/s
 L: ∞ dB
 R: ∞ dB
 0.0 dB

AUDIO	
Jitter (ms)	124
Received packets	347376
Lost packets	183
Late packets	0
Duplicated packets	0
Reordered packets	0
Recovered packets	0

Real-time network quality measurements at reception for the audio stream and the FEC stream if there is one

Call window (collapsed version):

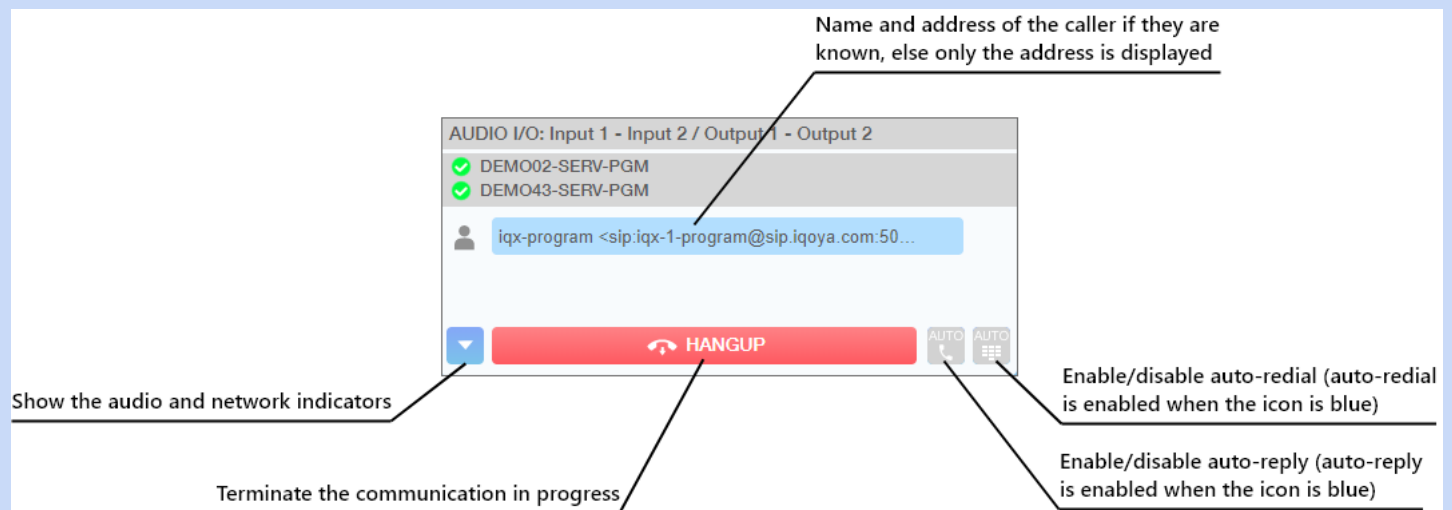

AUDIO I/O: Input 1 - Input 2 / Output 1 - Output 2

DEMO02-SERV-PGM
 DEMO43-SERV-PGM

iqx-program <sip:ixq-1-program@sip.iqoya.com:50...

Name and address of the caller if they are known, else only the address is displayed

Show the audio and network indicators

Terminate the communication in progress

Enable/disable auto-redial (auto-redial is enabled when the icon is blue)

Enable/disable auto-reply (auto-reply is enabled when the icon is blue)

8.2.1.6 Hang up a call

Click HANGUP button to terminate the communication.

When auto-redial is activated on the caller's side, only the caller can terminate the communication. If the callee hangs up, the communication is automatically re-established by the caller device.

8.2.2 “Connections” category of menus

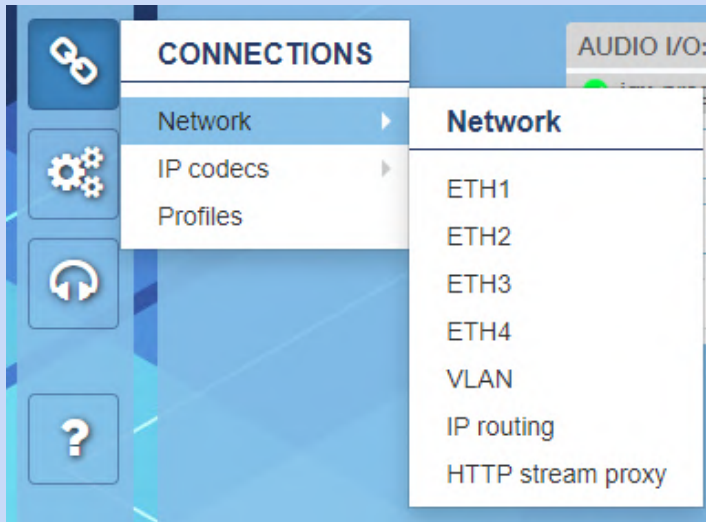

Click on  to display all the available menus. Move the mouse pointer above the menu to display the submenus. Click on a sub-menu to display the corresponding page.

8.2.2.1 Connections -> Network

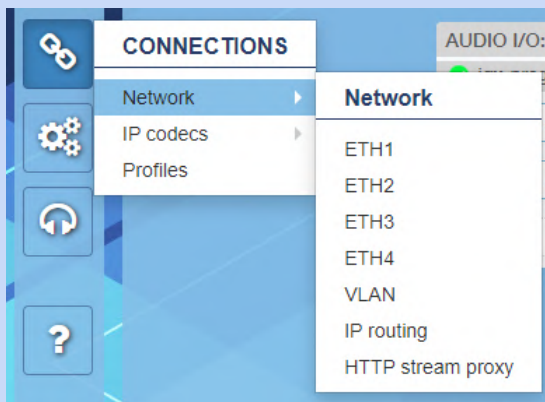

This menu allows accessing the network configuration of IQOYA X/LINK.

8.2.2.1.1 Connections -> Network -> ETHx

These pages allow configuring the four network ports of IQOYA X/LINK.

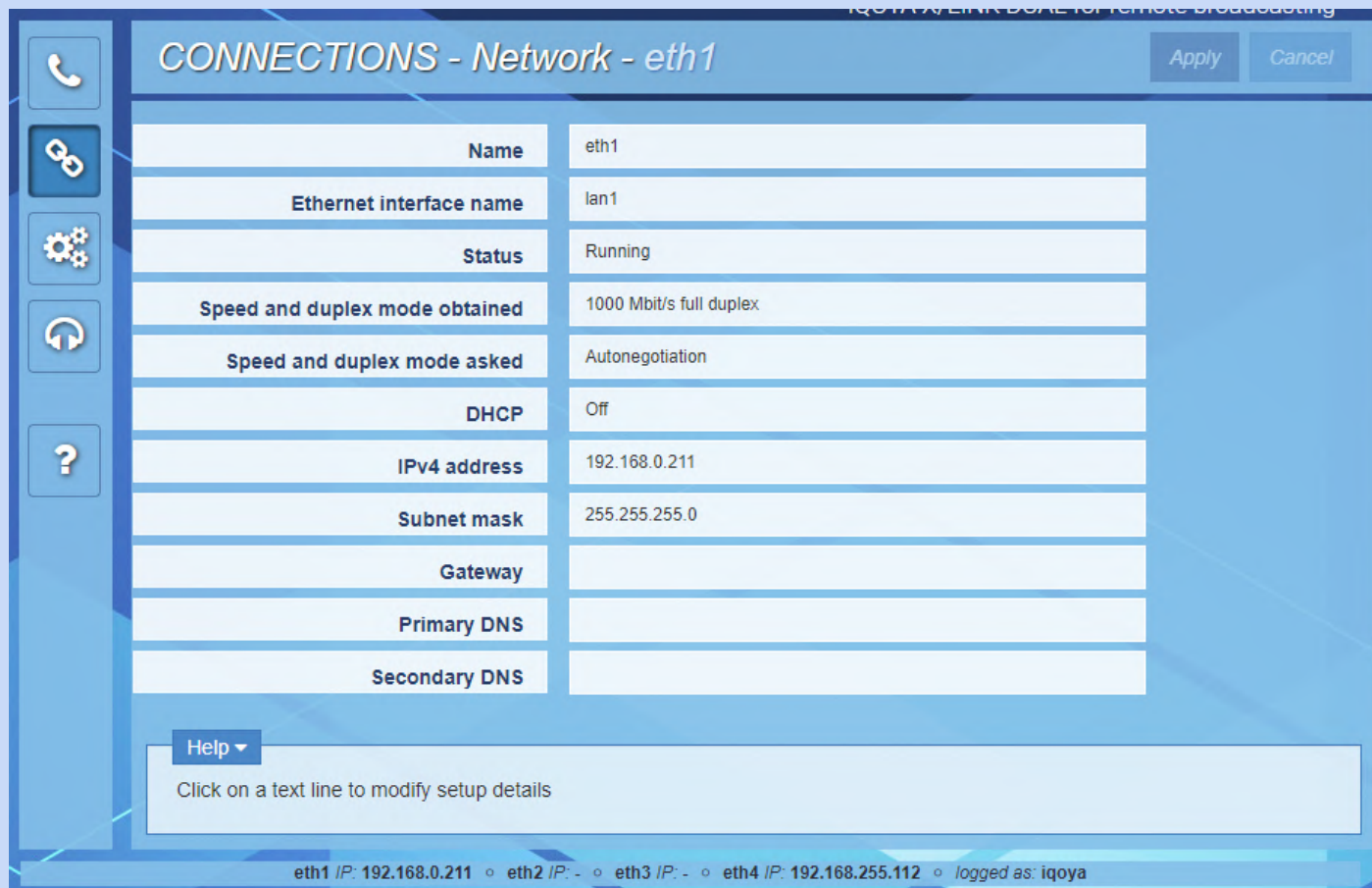

Parameter	Value
Name	eth1
Ethernet interface name	lan1
Status	Running
Speed and duplex mode obtained	1000 Mbit/s full duplex
Speed and duplex mode asked	Autonegotiation
DHCP	Off
IPv4 address	192.168.0.211
Subnet mask	255.255.255.0
Gateway	
Primary DNS	
Secondary DNS	

Click on a parameter field ("Status" for instance) to enter the editing mode.

Parameter	Type	Description
Name	R/W	This is the logical name of the ethernet interface which will be used in all the graphic user interfaces and in particular in the web pages. The names in the factory configuration are ETH1 to ETH4.
Ethernet interface name	Read	Displays the physical name of the ethernet ports. This parameter can't be changed.
Status	Read/Write	This parameter allows enabling/disabling the interface. Default value=Running. Possible values: Running: ethernet port is enabled. Stopped: ethernet port is disabled.
Speed and duplex mode obtained	Read	Displays the current speed and mode of the ethernet interface.
Speed and duplex mode asked	Read/Write	Allows selecting the working mode of the ethernet interface.

		<p>Possible values are as follows:</p> <div style="border: 1px solid black; padding: 5px; margin: 5px 0;"> <p>Autonegotiation</p> <hr/> <p>Autonegotiation</p> <p>1000 Mbit/s full duplex</p> <p>100 Mbit/s full duplex</p> <p>100 Mbit/s half duplex</p> <p>10 Mbit/s full duplex</p> <p>10 Mbit/s half duplex</p> </div> <p>We recommended to avoid the “Auto-negotiation” mode. Select the mode supported by the network node connected to the IQOYA X/LINK.</p>
DHCP	Read/Write	<p>Allows enabling/disabling DHCP (Dynamic Host Configuration Protocol). Default value is OFF (disabled). Click on “On” to enable DHCP. This mode disables the 5 following parameters.</p>
IPv4 address	Read only if DHCP is On Read/Write if DHCP is Off	<p>DHCP Off Default value is: 192.168.0.100 for Eth1, 192.168.1.100 for Eth2, 192.168.2.100 for Eth3, 192.168.3.100 for Eth4 Enter the IP address of this ethernet interface.</p> <p>DHCP On Displays the IP address automatically set by DHCP.</p>
Subnet mask	Read only if DHCP is On Read/Write if DHCP is Off	<p>DHCP Off Enter the mask of the subnetwork this ethernet port belongs to.</p> <p>DHCP On Displays the subnetwork mask automatically set by DHCP.</p>
Default Gateway	Read only if DHCP is On Read/Write if DHCP is Off	<p>DHCP Off Enter the default gateway IP address. Streams sent beyond the subnets configured on LAN1 to 4 will pass through this gateway except if specific routing rules has been defined in the IP routing page.</p> <p> Only one default gateway must be configured for all the ethernet interfaces. If several gateways has to be used, one can be set as default gateway, the others must be the subject of routing rules in the IP routing page.</p> <p>DHCP On Displays the gateway IP address automatically set by DHCP.</p>
Primary DNS	Read only if DHCP is On Read/Write if DHCP is Off	<p>DHCP Off Enter the IP address of the primary DNS (if any).</p> <p>DHCP On Displays the IP address of the DNS automatically set by DHCP.</p>
Secondary DNS	Read only if DHCP	DHCP Off

	is On Read/Write if DHCP is Off	Enter the IP address of the secondary DNS (if any). DHCP On Displays the IP address of the secondary DNS automatically set by DHCP (may be empty).
--	---------------------------------------	---

8.2.2.1.2 Connections -> Network -> VLAN

This page allows declaring VLANs on the ethernet interfaces. No VLAN is declared by default. Multiple VLANs can be declared for each ethernet interface.

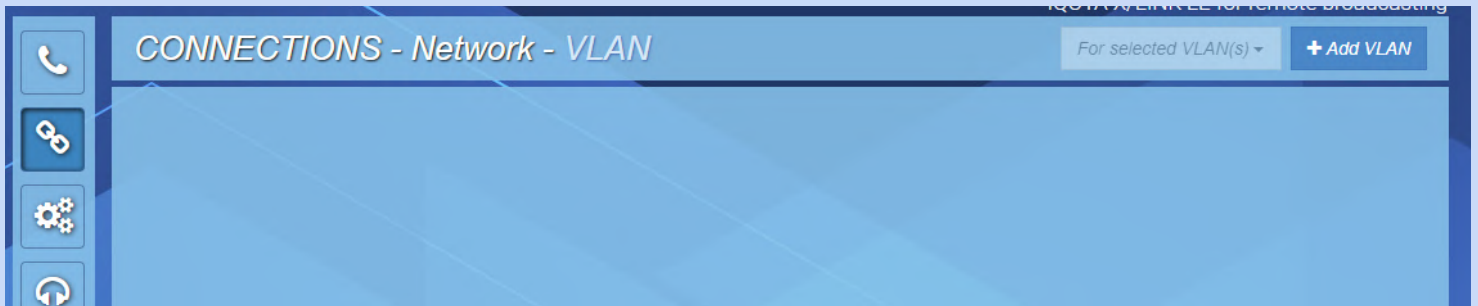

Click on “+Add VLAN” button to declare a new VLAN.

Add VLAN ✕

Network interface: ?

VLAN ID:

Name:

Status: ?

Priority: ?

IPv4 address:

Netmask:

Parameter	Type	Description
Network interface	Read/Write	Select the network interface that will support the VLAN (ETH1 to ETH4)
VLAN ID	Read/Write	Enter the VLAN ID in the ranges 1-4094. Avoid using ids 1002 to 1005 which are reserved.
Name	Read/Write	Enter a logical name for this VLAN
Status	Read/Write	Allows enabling/disabling this VLAN. Select “Running” to enable this VLAN. Select “Stopped” to disable this VLAN.
Priority	Read/Write	Enter the VLAN priority in the range 0-7.

IPv4 address	Read/Write	Enter the IP address of the selected ethernet port in this VLAN. If no value is entered, the IP address is the IP address of the selected ethernet port.
Netmask	Read/Write	Enter the netmask for this VLAN interface. If no value is entered, the netmask is the same as the selected ethernet port netmask.

8.2.2.1.3 Connections -> Network -> IP routing

This page allows viewing the current IP routing table, downloading it, and uploading a modified IP routing table.

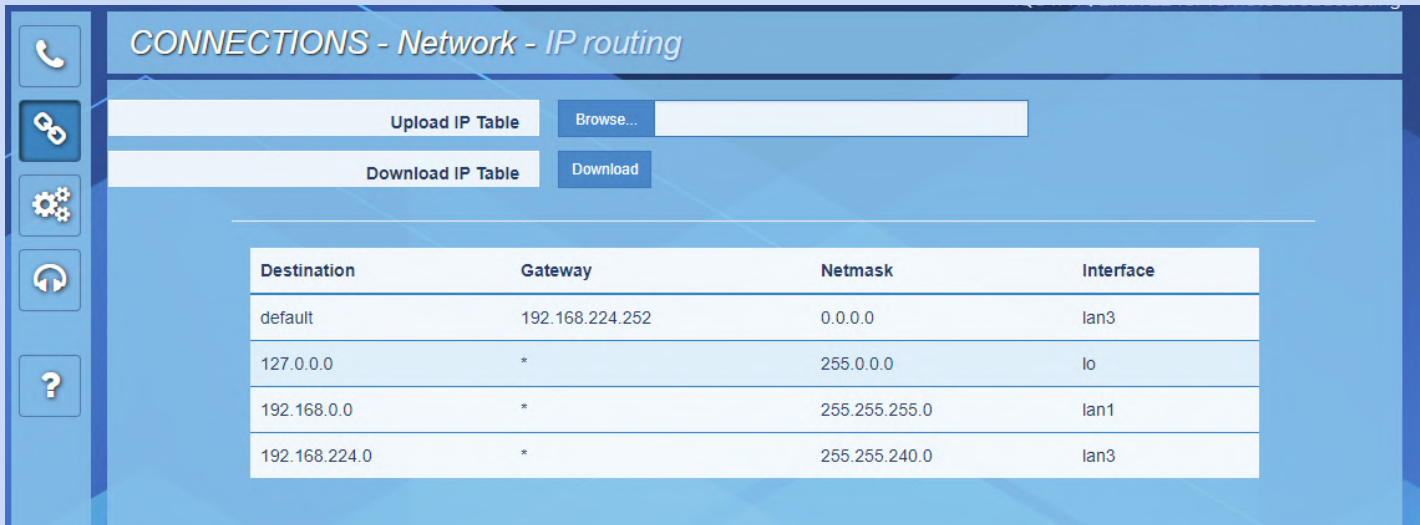

In case the routing table has to be modified, click on “Download”.

The routing table can be edited with a standard text editor (such as notepad). You may add IP routes, as described in the downloaded file. **Only the additional routes must appear in this file. Routes to directly accessible subnets are not present in this file and need not be added to this file.**

Note: In case you use more than one ethernet interface, do not declare several gateways. Declare instead one default gateway, for instance on Eth0, and declare routes on other ethernet interfaces through this routing table.

8.2.2.2 Connections -> IP codecs

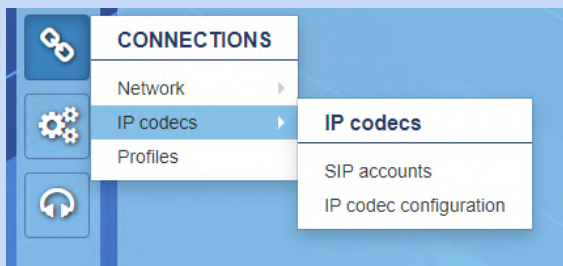

This menu allows accessing the configuration of the IP codec instances.

8.2.2.2.1 Connections -> IP codecs -> SIP accounts



This page shows the declared SIP accounts and allows declaring new SIP accounts or editing/deleting existing ones. The SIP accounts declared in this page can be used by IP codec instances to register on SIP servers.

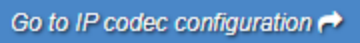

Display name	SIP address
  DEMO02-SERV-PGM	iqs-madi-20007-02-program@sip.digidemo.iqoya.com:5060
  DEMO02-SERV-TB	iqs-madi-20007-02-talkback@sip.digidemo.iqoya.com:5060
  DEMO03-SERV-PGM	iqs-madi-20007-03-program@sip.digidemo.iqoya.com:5060
  DEMO03-SERV-TB	iqs-madi-20007-03-talkback@sip.digidemo.iqoya.com:5060
  DEMO27-SERV-PGM	iqs-madi-20007-27-program@sip.digidemo.iqoya.com:5060
  DEMO27-SERV-TB	iqs-madi-20007-27-talkback@sip.digidemo.iqoya.com:5060

The shortcut  allows to quickly jump to the IP codec configuration page described below.

8.2.2.2.1.1 Declare a new SIP account

To declare a new SIP account, click on , or create it from an existing one by clicking the icon  on the left of this latter. Then provide the requested parameters and click on the "Save" button. To cancel the declaration of a new SIP account, you can click on the "Close" button at any time. The requested parameters are described below:

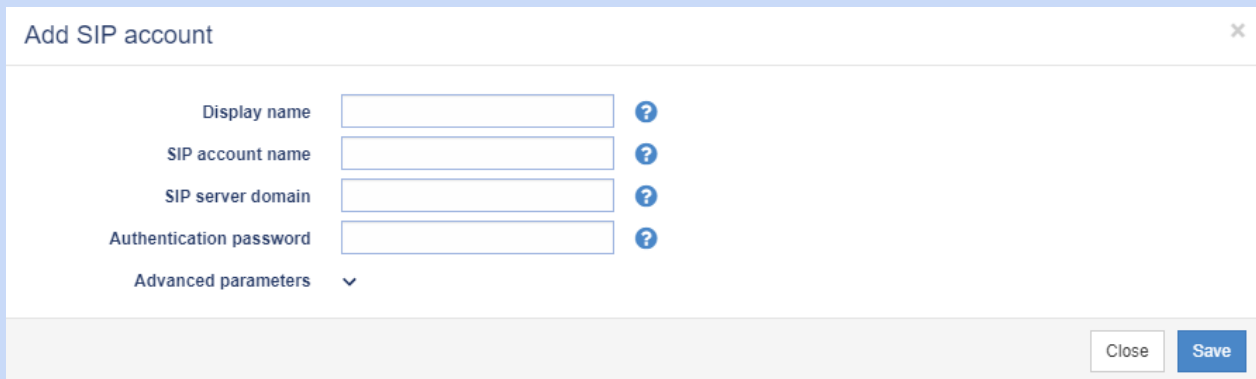

SIP account parameter	Type	Description
-----------------------	------	-------------

Display name	Read/Write	Name given to this SIP account. This name will be presented to the remote party at call time by the codec instance registered with this SIP account.
SIP account name	Read/Write	Name that will be used to register with the SIP server (also called SIP registrar).
SIP server domain	Read/Write	Domain name or the IP address of the SIP server (also called SIP registrar) providing the SIP account.
Authentication password	Read/Write	The access to the SIP server is usually protected by an authentication name and password. This is the password of the SIP account on the SIP server.

With some SIP infrastructures you might have to adjust advanced parameters. Click on the chevron to access to the advanced parameters:

Add SIP account ×

Display name ?

SIP account name ?

SIP server domain ?

Authentication password ?

Advanced parameters ^

Authentication name ?

SIP server port ?

SIP account advanced parameter	Type	Description
Authentication name	Read/Write	The access to the SIP server is usually protected by an authentication name and password. This is the authentication name of the SIP account on the SIP server. This parameter is optional, if no authentication name is provided, the SIP account name will be used.
SIP server port	Read/Write	Listening port of the SIP server providing the SIP account. This parameter is optional, if no listening port is provided 5060 the default SIP listening port is used.

8.2.2.2.1.2 Edit a SIP account

To edit an existing SIP account, click the icon  on the left of this latter.
The edit page is identical to the add page described in the previous paragraph.

8.2.2.2.1.3 Delete a SIP account

To delete a SIP account, click the icon  on the left of this latter.

Only SIP accounts that are not currently used to register IP codec instances can be deleted.

8.2.2.2.2 Connections -> IP codecs -> IP codec configuration

This page shows the IP codec instances and allows creating new IP codec instances or editing/deleting existing ones. The IP codec instances created on this page must be activated to be operational and to appear in the codec mosaic of the “Operations” page.

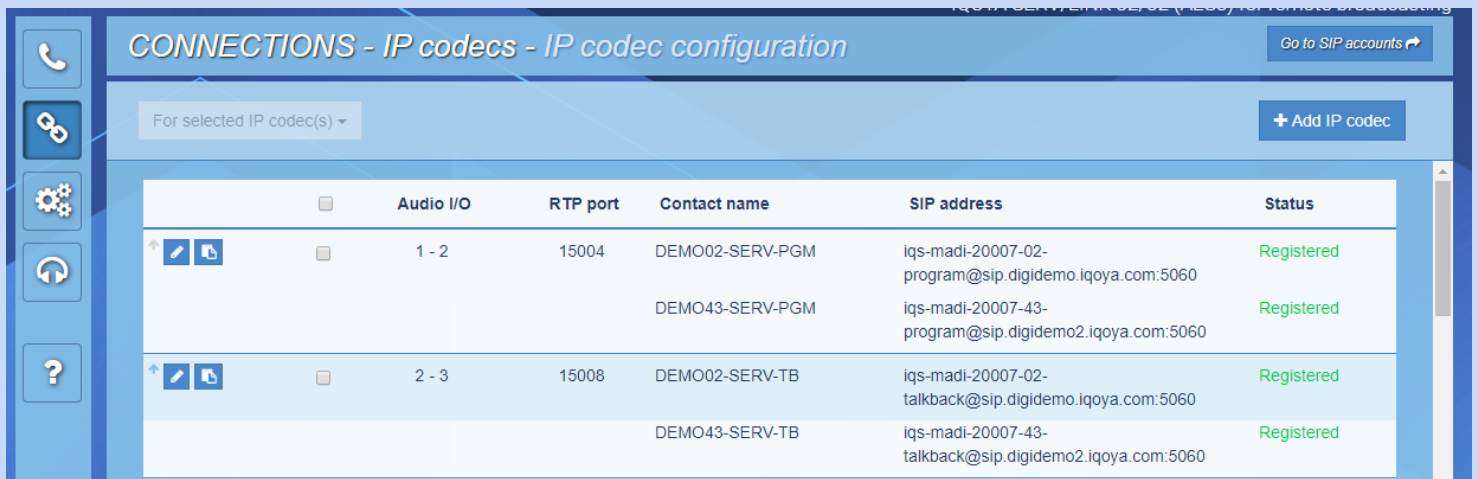





	Audio I/O	RTP port	Contact name	SIP address	Status
<input type="checkbox"/>	1 - 2	15004	DEMO02-SERV-PGM	iqs-madi-20007-02-program@sip.digidemo.iqoya.com:5060	Registered
			DEMO43-SERV-PGM	iqs-madi-20007-43-program@sip.digidemo2.iqoya.com:5060	Registered
<input type="checkbox"/>	2 - 3	15008	DEMO02-SERV-TB	iqs-madi-20007-02-talkback@sip.digidemo.iqoya.com:5060	Registered
			DEMO43-SERV-TB	iqs-madi-20007-43-talkback@sip.digidemo2.iqoya.com:5060	Registered

This page shows the following parameters for each IP codec instance:

- **Audio I/O:** The audio I/Os associated with the IP codec instance.
- **RTP port:** The port used by the the IP codec instance to listen to the IP audio stream coming from the remote party.
- **Contact name:** The display names of the SIP accounts used to register the IP codec instance with SIP servers (only SIP is activated for this instance). There can be up to 2 registrations per IP codec instance.
- **SIP address:** The SIP addresses of the IP codec instance, one per registration.
- **Status:** The status of the IP codec instance is empty when the IP codec instance is disabled else the possible statuses are:
 - **“Registered”:** SIP is activated and the IP codec instance is successfully registered with the SIP server.
 - An error message in red: SIP is activated and the IP codec instance fails to register with the SIP server. The possible error messages are:
 - **“Invalid address, check DNS”:** the SIP domain is wrong,
 - **“Unknown name or user”:** the SIP account name, the SIP authentication name or the SIP authentication password is wrong.
 - **“No remote response”:** The SIP server is unreachable.
 - **“Not registered”:** The user has manually unregistered the IP codec instance.
 - **“Ready”:** SIP is not activated and the IP codec instance is ready for a symmetric RTP connection.

- **“Failed”**: SIP is not activated and the IP codec instance is not ready for a symmetric RTP connection probably because the audio listening port is not available.

8.2.2.2.1 Create a new IP codec instance

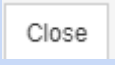
To create a new IP codec instance, click on  button, or create it from an existing one by clicking the icon  on the left of this latter. Then provide the requested parameters and click on the  button. To create several instances successively, click on  rather than on . To cancel the creation of a new IP codec instance, you can click on the  button at any time.

The requested parameters are described below:

- Parameters related to the audio I/Os

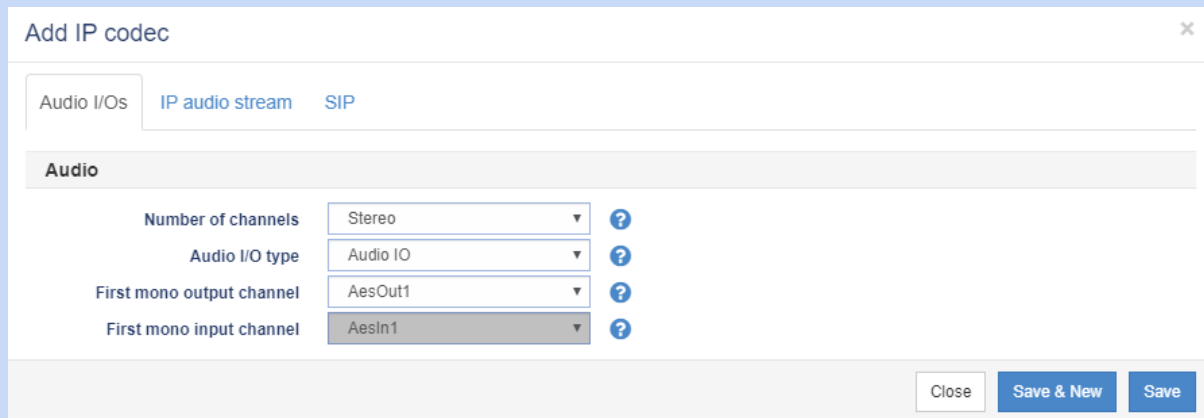

IP codec parameter	Type	Description
Number of channels	Read/Write	Number of audio channels managed by the IP codec instance. It can be Mono or Stereo.
Audio I/O type	Read/Write	Type of the audio I/Os allocated to the IP codec instance. It can be “Audio IO” for Analog or AES/EBU I/Os or “AoIP” for AES67 audio channels.
First mono output channel	Read/Write	First mono audio output allocated to the IP codec instance. If the IP codec instance is stereo, the next mono audio output is also allocated to the instance. Audio outputs already allocated are greyed out in the drop-down menu.
First mono input channel	Read/Write	First mono audio input allocated to the IP codec instance. If the IP codec instance is stereo, the next mono audio input is also allocated to the instance. By default, the input with the same number as the output is allocated.

- Parameters related to the IP audio stream received from the remote party

Add IP codec
✕

Audio I/Os
IP audio stream
SIP

IP audio stream

Use SIP signaling ?

Jitter buffer size(ms) ?

Audio stream listening port ?

FEC stream listening port ?

Advanced parameters ^

RTCP listening port ?

RTCP listening port related to FEC ?

Audio stream loss duration (ms) ?

Close
Save & New
Save

IP codec parameter	Type	Description
Use SIP signaling	Read/Write	Check this box if you want to establish connections via SIP (through a SIP infrastructure or directly). Checking this box brings up the SIP configuration tab.
Jitter buffer size(ms)	Read/Write	Size of the jitter buffer for the IP audio stream received from the remote party in milliseconds. The larger the buffer, the more the IP codec instance is immune to the network jitter but the higher the latency.
Audio stream listening port	Read/Write	Number of the UDP port used by the IP codec instance to listen to the IP audio stream coming from the remote party.
FEC stream listening port	Read/Write	Number of the UDP port used by the IP codec instance to listen to the FEC stream coming from the remote party if there is one.
Click on the chevron to access to these advanced parameters:		
RTCP listening port	Read/Write	Number of the UDP port used to listen to the RTCP traffic related to the audio stream coming from the remote party.
RTCP listening port related to FEC	Read/Write	Number of the UDP port used to listen to the RTCP traffic related to the FEC stream coming from the remote party.
Audio stream loss duration (ms)	Read/Write	When the IP codec instance no longer receives the IP audio stream from the remote party for a duration equal to this parameter value, a hang-up is triggered as if the hang-up button has been pressed. The value is expressed in milliseconds and must be greater than 100ms.

- Parameters related to SIP

Add IP codec
✕

Audio I/Os
IP audio stream
SIP

SIP

Primary SIP account ?

Secondary SIP account ?

Advanced parameters ^

Transport protocol ?

Listening network interface ?

Listening port ?

Auto registration ?

Registration every (secondes) ?

Outbound proxy activation ?

Allows symmetric RTP connections without SIP ?

Presence

Presence activation ?

Notification lease (seconds) ?

Net topology-related settings

Connection to public internet ?

Others

Fallback FEC scheme ?

IP codec parameter	Type	Description
SIP section		
Primary SIP account	Read/Write	Primary SIP account to be used by the codec instance to register with a SIP server
Secondary SIP account	Read/Write	The codec instance can register on 2 SIP servers at the same time. So if one SIP infrastructure breaks down, the codec remains accessible through the other infrastructure. This is useful for example to implement a disaster recovery plan. This is the SIP account to be used by the codec instance to register with a secondary SIP server

Click on the chevron to access to these advanced parameters:

Transport protocol	Read/Write	The protocol to be used to transport SIP signaling. It can be UDP or TCP. The choice depends on your SIP infrastructure. IQOYA CONNECT, Digigram's SIP infrastructure, supports both but UDP is preferable.
Listening network interface	Read/Write	The network interface to be used by the IP codec instance to listen to the SIP signaling. Use "Any" if you do not have instructions from your IT team on this.
Listening port	Read/Write	Port to be used by the IP codec instance to listen to the SIP signaling. The web interface proposes you a free port. Keep the proposed value to avoid port conflicts.
Auto registration	Read/Write	'Yes' enables automatic and periodic SIP registration(s) of the IP codec instance with the SIP server(s). The refresh period of the SIP registration is defined below. 'No' disables the automatic and periodic SIP registration(s) of the IP codec instance with the SIP server(s). Note that manual registration is possible in the call window.
Registration every (seconds)	Read/Write	This is the refresh period of the SIP registration in seconds. It is not recommended to enter a value below 30s. The default value is 120.
Outbound proxy activation	Read/Write	Enable/disable the use of an outbound SIP proxy.
Outbound proxy domain	Read/Write	Visible only if "Outbound proxy activation" is yes. This is the IP address or the domain name of the outbound SIP proxy.
Outbound proxy port	Read/Write	Visible only if "Outbound proxy activation" is yes. This is the listening port of the outbound SIP proxy.
Allows symmetric RTP connections without SIP	Read/Write	Enables/disables the possibility of also establishing or accepting symmetric RTP connections.
Presence		
Presence activation	Read/Write	Enable/disable the SIP presence service. Do not disable the SIP presence service if you use Digigram's SIP infrastructure IQOYA CONNECT.
Notification lease (seconds)	Read/Write	This is the refresh period of the subscription to the presence service. The lease value must be greater than the field 'Registration every (seconds)'. The default value is 3600.
Net topology-related settings		
Connection to public internet	Read/Write	Select the proposition that best matches with your internet connection topology. Ask you IT team if you don't know. If you are using IQOYA CONNECT, Digigram's SIP infrastructure, choose "Direct" because IQOYA CONNECT integrates a NAT traversal solution.
Public IP address	Read/Write	Visible only if "Connection to public internet" is "From behind NAT specifying public address". Enter the public IP address or domain name of the device.

STUN server address	Read/Write	Visible only if “Connection to public internet” is “From behind NAT using STUN”. This is the IP address or domain name of a STUN server.
STUN server port	Read/Write	Visible only if “Connection to public internet” is “From behind NAT using STUN”. This is the listening port of the STUN server.
Others		
Fallback FEC scheme	Read/Write	The IP codec instance enables the FEC scheme given here when the SIP signaling coming from a third party codec requires a FEC stream without specifying any FEC scheme. In this case, the FEC scheme used by the third party codec needs to match this fallback FEC scheme. Note that this field is only relevant with SIP and has no use for a communication between two Digigram’s codecs.

8.2.2.2.2 Enable IP codec instances

After creation, the IP codec instances must be enabled to appear in the “Operations” page.

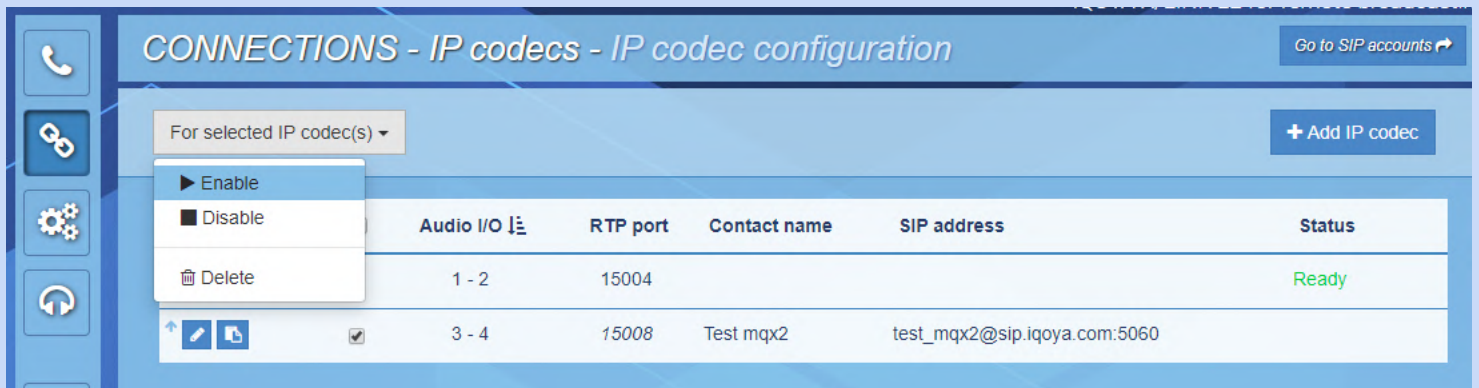

To enable IP codec instances, select them checking the box on the corresponding lines of the list, then open “For selected IP codec(s)” menu at the top of the list and click “Enable” item.

Once enabled, the codec is added to the “Operations” page.

The enabled IP codec instances appear on the “Operations” page in the same order as they appear in the list. It is possible to reorder the list clicking the “up” icon present at the beginning of each line:

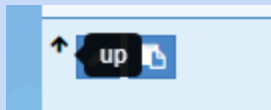

To test an enabled IP codec instance, it is possible to access its call page clicking the call icon at the beginning of the line:

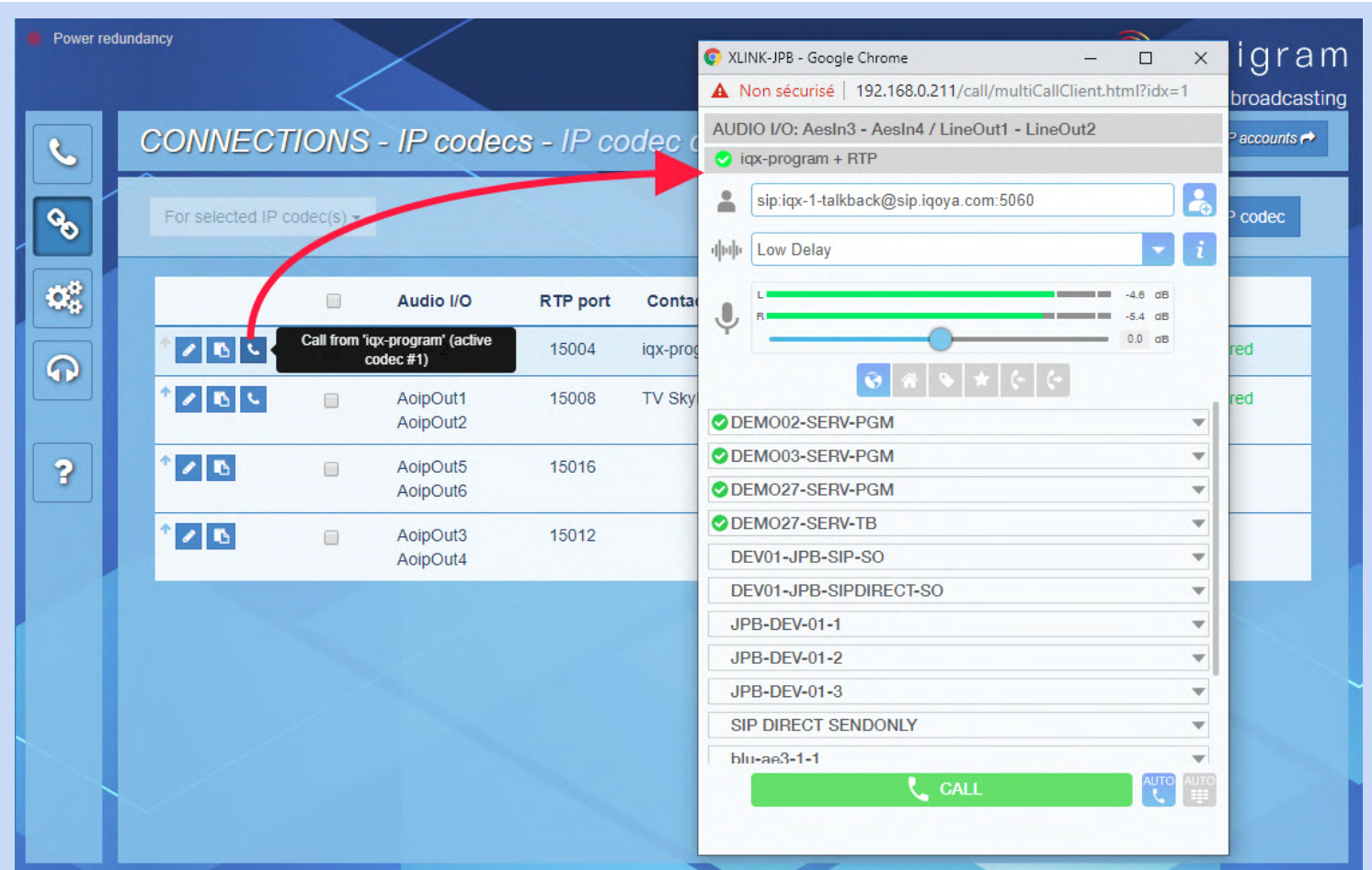

8.2.2.2.3 Edit an IP codec instance

It is possible to edit for modification an existing IP codec instance.

Click the pencil icon  on the line of the IP codec instance you want to modify to start editing. The edition gives access to the same settings pages as the creation:

- Parameters related to the audio I/Os

Edit IP codec configuration
RTP 15004 / in Input 1+Input 2 / out Output 1+Output 2
✕

Audio I/Os

IP audio stream

Audio

Number of channels	<input type="text" value="Stereo"/> ?
Audio I/O type	<input type="text" value="Audio IO"/> ?
First mono output channel	<input type="text" value="Output 1"/> ?
First mono input channel	<input type="text" value="Input 1"/> ?

Refer to the paragraph "Create a new IP codec instance" to know the meaning of the each parameter.

- Parameters related to the IP audio stream received from the remote party

Edit IP codec configuration
RTP 15004 / in Input 1+Input 2 / out Output 1+Output 2
✕

Audio I/Os

IP audio stream

SIP

IP audio stream

Use SIP signaling	<input checked="" type="checkbox"/> ?
Jitter buffer size(ms)	<input type="text" value="200"/> <input type="text" value="ms"/> ?
Audio stream listening port	<input type="text" value="15004"/> ?
FEC stream listening port	<input type="text" value="15006"/> ?
Advanced parameters	<input type="text" value=""/> ?

Refer to the paragraph "Create a new IP codec instance" to know the meaning of the each parameter.

- Parameters related to SIP

Edit IP codec configuration
RTP 15004 / in Input 1+Input 2 / out Output 1+Output 2
✕

Audio I/Os
IP audio stream
SIP

SIP

Primary SIP account ?

Secondary SIP account ?

Advanced parameters

Transport protocol ?

Listening network interface ?

Listening port ?

Auto registration ?

Registration every (seconds) s ?

Outbound proxy activation ?

Allows symmetric RTP connections without SIP ?

Presence

Presence activation ?

Notification lease (seconds) s ?

Net topology-related settings

Connection to public internet ?

Others

Fallback FEC scheme ?

Refer to the paragraph "Create a new IP codec instance" to know the meaning of the each parameter.

8.2.2.2.2.4 Disable IP codec instances

To disable IP codec instances, select them checking the box on the corresponding lines of the list, then open "For selected IP codec(s)" menu at the top of the list and click "Disable" item.

Once disabled, the IP codec instance disappeared from the "Operations" page.

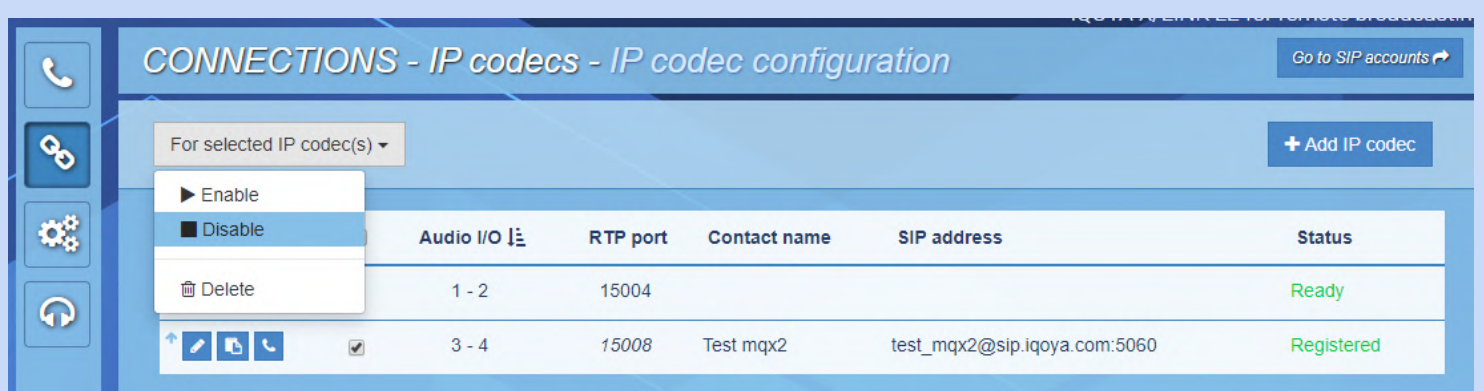

8.2.2.2.2.5 Delete IP codec instances

To delete IP codec instances, select them checking the box on the corresponding lines of the list, then open “For selected IP codec(s)” menu at the top of the list and click “Delete” item.

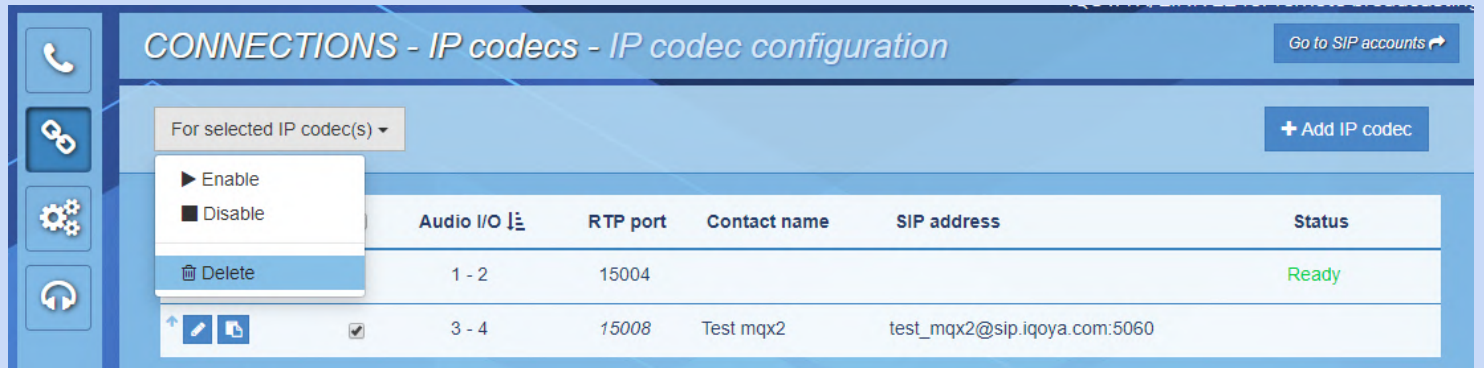

 An IP codec instance must be disabled before it can be deleted.

8.2.2.3 Connections -> Profiles

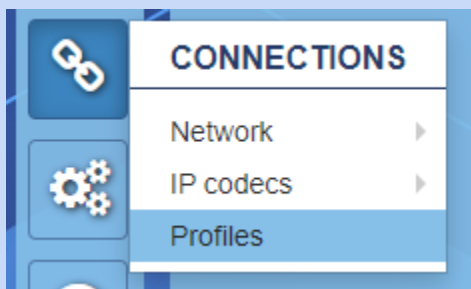

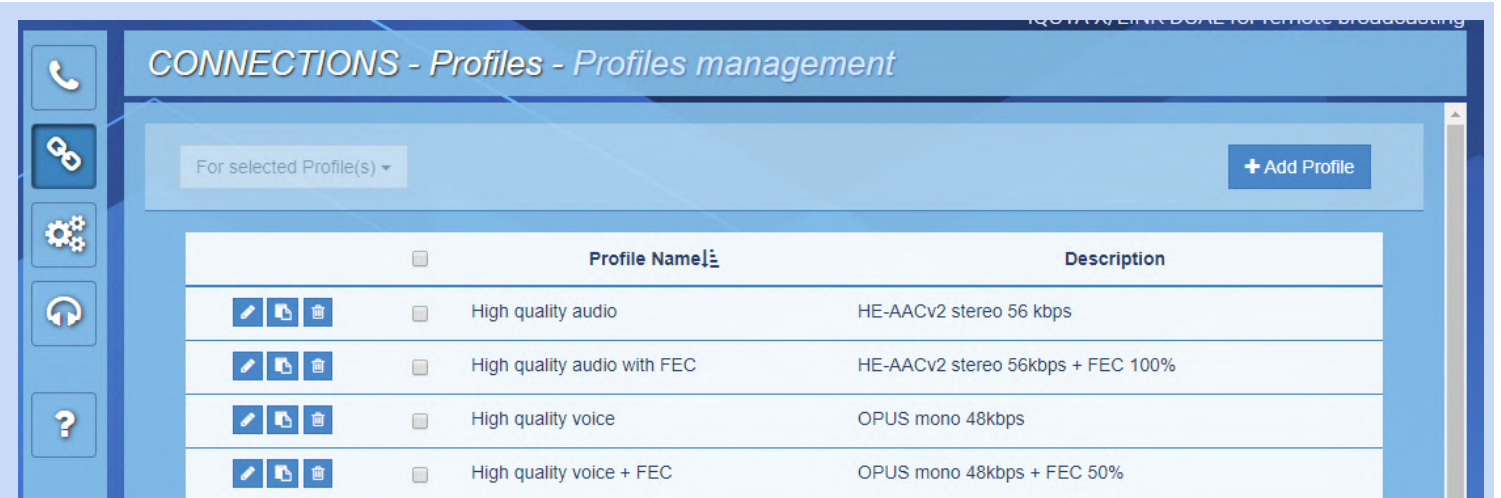

This menu gives access to the call profile management page. This page allows you to add, modify or delete call profiles stored only locally on the device.

The profile management page shows the list of local call profiles currently defined:



8.2.2.3.1 Add a call profile

To create a new call profile, click on , or create it from an existing one by clicking the icon  on the left of this latter. Then provide the requested parameters and click on the "Save" button. To cancel the

creation of a new call profile, you can click on the "Close" button at any time.

Add profile
✕

Name ?

Description ?

Use a specific jitter buffer size ?

Jitter buffer size (ms) ms ?

Sent stream settings

Audio encoding format ?

Forward error correction ?

Advanced parameters ^

Audio stream payload type ?

Packet size (ms) ms ?

FEC stream payload type ?

DSCP ?

Advise jitter buffer size to callee ?

Jitter buffer size to advise (ms) ms ?

Received stream settings

Asymmetric settings ?

Audio encoding format ?

Forward error correction ?

Advanced parameters ^

Audio stream payload type ?

Packet size (ms) ms ?

FEC stream payload type ?

The parameters requested at creation are described below:

SIP account parameter	Type	Description
Name	Read/Write	Name of the call profile
Description	Read/Write	Call profile description
Use a specific jitter buffer size	Read/Write	This parameter defines the jitter buffer size to be used when the user selects the profile at call time: - Checked: the specific jitter buffer size specified below will be used, - Unchecked: the default jitter buffer size defined at IP codec instance level will be used.
Jitter buffer size (ms)	Read/Write	Visible only if "Use a specific jitter buffer size" is checked.

		Size of the jitter buffer to be allocated by the IP codec instance when the user selects this profile at call time.
Sent stream settings section		
Audio encoding format	Read/Write	Audio encoding format of the stream sent to the remote party.
Forward error correction	Read/Write	<p>Forward Error Correction (FEC) is a technique used to reduce data transmission errors on unreliable networks by sending additional information allowing to correct them.</p> <p>This parameter allows to select the FEC scheme for the FEC stream sent to the remote party. Possible values are:</p> <ul style="list-style-type: none"> • No FEC stream • +50% bandwidth, recovery 2, 1 stream (audio) • +100% bandwidth, recovery 3, 2 streams (audio + FEC) • +100% bandwidth, recovery 4, 2 streams (audio + FEC) • +50% bandwidth, recovery 1/2, 2 streams (audio + FEC) • +33% bandwidth, recovery 1/3, 2 streams (audio + FEC) • +25% bandwidth, recovery 1/4, 2 streams (audio + FEC) • +20% bandwidth, recovery 1/5, 2 streams (audio + FEC) • +10% bandwidth, recovery 1/10, 2 streams (audio + FEC) <p>'recovery N' means that up to N consecutive lost IP packets can be reconstructed thanks to the FEC scheme, 'recovery 1/N' means one lost IP packet out of N consecutive packets can be reconstructed thanks to the FEC scheme.</p>
Advanced parameters:		
Audio stream payload type	Read/Write	Payload type of the audio stream sent to the remote party. It's an integer between 0 and 127.
Packet size (ms)	Read/Write	<p>Defines the size in ms of the audio packets sent to the remote party or 0 to use the default value.</p> <p>The packet size is the amount of audio data to be put in the network packets, expressed in ms.</p> <p>For PCM, G711, G722, and aptX formats: The entered value is adjusted to the nearest greater or equal multiple of the processing granularity. It is the amount of audio samples processed by the audio engine at each cycle.</p> <p>For MPEG formats: The entered value is adjusted to the nearest greater or equal multiple of the MPEG frame.</p> <p>For AAC formats: The entered value is adjusted to the nearest greater or equal multiple of the AAC frame.</p>
FEC stream payload type	Read/Write	Payload type of the FEC stream sent to the remote party. It's an integer between 0 and 127.
DSCP	Read/Write	<p>Defines the Quality of Service (QoS) class for the audio stream as defined in the Differentiated Services Code Point (DSCP) standard.</p> <p>Possible values are:</p> <ul style="list-style-type: none"> • Default • Class 1

		<ul style="list-style-type: none"> • Class 2 • Class 3 • Class 4 • Class 5 • Class 6 • Class 7 • Assured Forwarding 11 (AF 11) • Assured Forwarding 12 (AF 12) • Assured Forwarding 13 (AF 13) • Assured Forwarding 21 (AF 21) • Assured Forwarding 22 (AF 22) • Assured Forwarding 23 (AF 23) • Assured Forwarding 31 (AF 31) • Assured Forwarding 32 (AF 32) • Assured Forwarding 33 (AF 33) • Assured Forwarding 41 (AF 41) • Assured Forwarding 42 (AF 42) • Assured Forwarding 43 (AF 43) • Expedited Forwarding (EF)
Advise jitter buffer size to callee	Read/Write	This parameter can be checked to recommend a size for the receiving jitter buffer of the remote party's device.
Jitter buffer size to advise (ms)	Read/Write	Visible only if "Advise jitter buffer size to callee" is checked. This parameter is the recommended size for the receiving jitter buffer of the remote party's device. The size is in milliseconds.
Receive stream settings section		
Asymmetric settings	Read/Write	<p>This parameters allows to negotiate different settings for the audio stream sent by the remote party than for the audio stream sent to the remote party.</p> <ul style="list-style-type: none"> - Checked: The settings for the audio streams sent by the remote party and to the remote party are different. - Unchecked: The settings for the audio streams sent by the remote party and to the remote party are the same.
Audio encoding format	Read/Write	Visible only if "Asymmetric settings" is checked. Audio encoding format of the stream sent by the remote party.
Forward error correction	Read/Write	<p>Visible only if "Asymmetric settings" is checked. Forward Error Correction (FEC) is a technique used to reduce data transmission errors on unreliable networks by sending additional information allowing to correct them.</p> <p>This parameter allows to select the FEC scheme for the FEC stream sent by the remote party. Possible values are:</p> <ul style="list-style-type: none"> • No FEC stream • +50% bandwidth, recovery 2, 1 stream (audio) • +100% bandwidth, recovery 3, 2 streams (audio + FEC) • +100% bandwidth, recovery 4, 2 streams (audio + FEC) • +50% bandwidth, recovery 1/2, 2 streams (audio + FEC) • +33% bandwidth, recovery 1/3, 2 streams (audio + FEC)

		<ul style="list-style-type: none"> +25% bandwidth, recovery 1/4, 2 streams (audio + FEC) +20% bandwidth, recovery 1/5, 2 streams (audio + FEC) +10% bandwidth, recovery 1/10, 2 streams (audio + FEC) <p>'recovery N' means that up to N consecutive lost IP packets can be reconstructed thanks to the FEC scheme, 'recovery 1/N' means one lost IP packet out of N consecutive packets can be reconstructed thanks to the FEC scheme.</p>
Advanced parameters:		
Audio stream payload type	Read/Write	Visible only if "Asymmetric settings" is checked. Payload type of the audio stream sent by the remote party. It's an integer between 0 and 127.
Packet size (ms)	Read/Write	Visible only if "Asymmetric settings" is checked. Defines the size in ms of the audio packets sent by the remote party or 0 not to negotiate the packet size.
FEC stream payload type	Read/Write	Visible only if "Asymmetric settings" is checked. Payload type of the FEC stream sent by the remote party. It's an integer between 0 and 127.

8.2.2.3.2 Edit a call profile

To edit an existing call profile, click the icon  on the left of this latter.
The edit page is identical to the add page described in the previous paragraph.

8.2.2.3.2 Delete call profiles



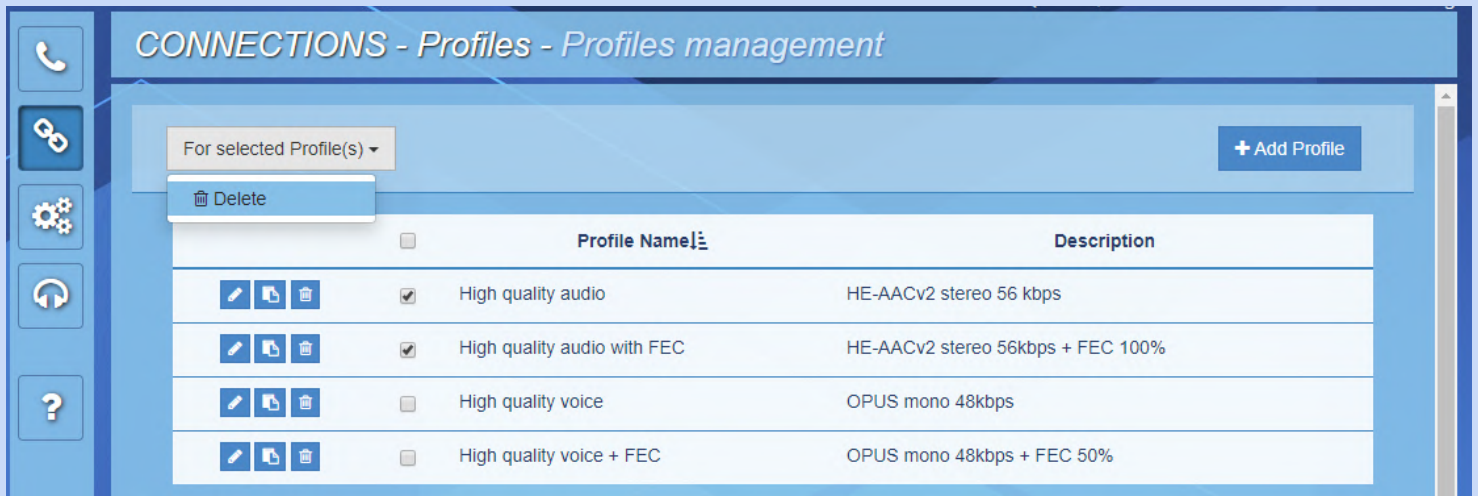









To delete a call profile, click the icon  on the left of this latter.
To delete several call profiles at the same time, check the box of the call profiles you want to delete then click "Delete" item in the "For selected Profile(s)" menu at the top of the page:



CONNECTIONS - Profiles - Profiles management

For selected Profile(s) + Add Profile

Delete

	<input type="checkbox"/>	Profile Name	Description
  	<input checked="" type="checkbox"/>	High quality audio	HE-AACv2 stereo 56 kbps
  	<input checked="" type="checkbox"/>	High quality audio with FEC	HE-AACv2 stereo 56kbps + FEC 100%
  	<input type="checkbox"/>	High quality voice	OPUS mono 48kbps
  	<input type="checkbox"/>	High quality voice + FEC	OPUS mono 48kbps + FEC 50%

8.2.3 “Advanced settings” category of menus

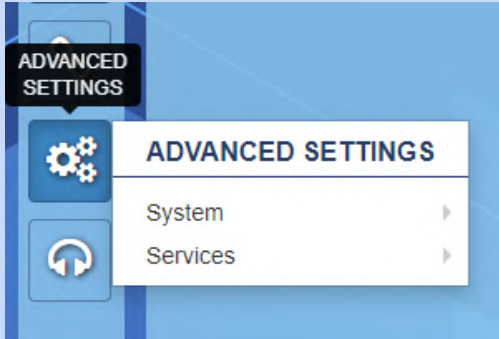

8.2.3.1 Advanced settings -> System

8.2.3.1.1 Advanced settings -> System -> Properties

This page displays the system properties:

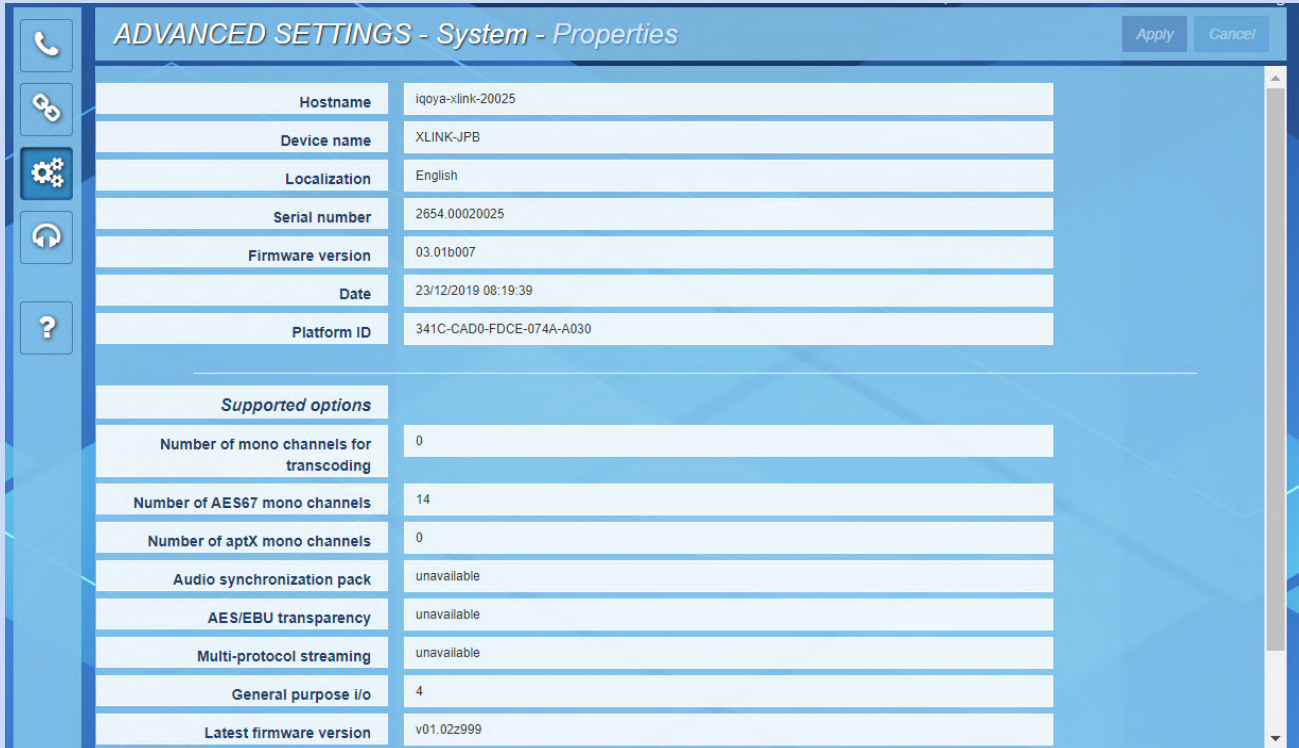

Description of the parameters:

Parameter	Read/Write	Meaning
Hostname	R / W	Logical name given to the device on the network.
Device Name	R / W	Name given to the equipment
Localization	R / W	Language

Serial number	R	Serial number of the unit. This number is set in factory and cannot be changed.
Firmware version	R	Version of the firmware running on the unit. The firmware can be update.
Date	R / W	Date and time of the unit.
Platform ID	R	Identifier of the unit. this number is required for applying firmware options.
Supported Options		
Number of mono channels for transcoding	R	Number of mono channels supported for transcoding through internal buses.
Number of AES67 mono channels	R	Number of mono input and output channels on AES67 or Ravenna, or Livewire
Number of aptX mono channels	R	Number of mono channels to be processed in aptX
Audio synchronous pack	R	Value 1: the codec features the audio synchronization via NTP, PTP, or 10 MHz / 1PPS, and the clock synchro on 10 MHz. Value 0 : the option is not installed.
AES/EBU transparency	R	Value 1: the codec allows for AES transparency transport. Value 0; the option is not installed.
Multiprotocol streaming	R	Value 1: the codec features the multiprotocol streaming. Value 0: the option is not installed
Latest firmware version	R	Maximum firmware version number authorized by the ongoing support contract.
Support contract validity date	R	Defines the date until when the firmware can be updated/upgraded according to the purchased support contract.

8.2.3.1.2 Advanced settings -> System -> Audio Clock

This page allows defining the X/LINK sampling clock source:

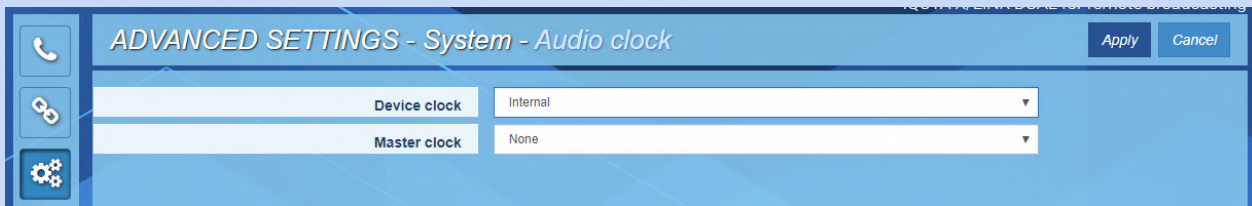

ADVANCED SETTINGS - System - Audio clock	
Device clock	Internal
Master clock	None

Device clock

The clock source can be:

- Internal: on-board clock
- Extracted from an AES/EBU input (not available on X/LINK-AES67)
- A PTP clock (AES67, RAVENNA)
- A Livewire clock

The clock sampling frequency value is set from Preferences->Audio setup.

Master clock

Allows defining if the codec generates a PTP clock.

8.2.3.1.2.1 PTP clock source

The following parameters appear when the mode "PTP AES67 Slave" is selected:

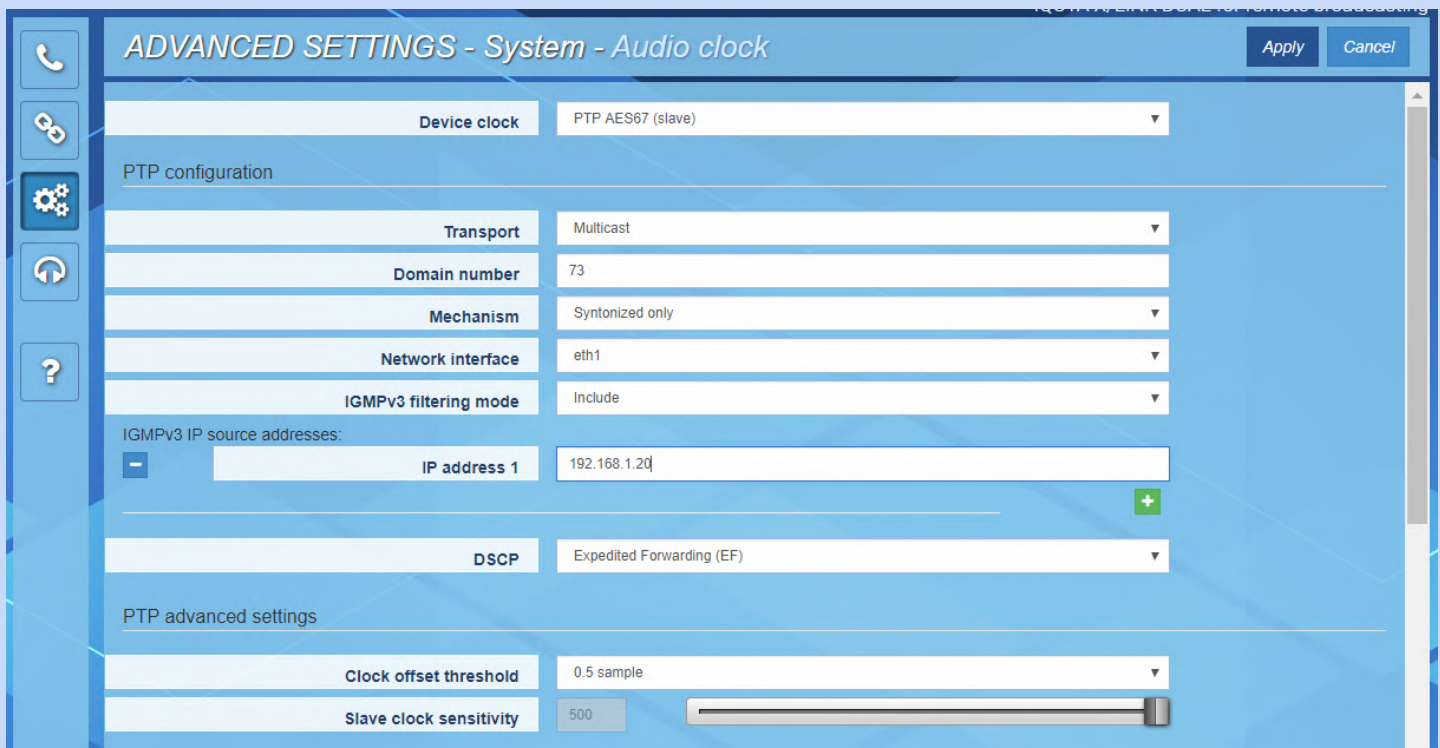

ADVANCED SETTINGS - System - Audio clock	
Device clock	PTP AES67 (slave)
PTP configuration	
Transport	Multicast
Domain number	73
Mechanism	Syntonized only
Network interface	eth1
IGMPv3 filtering mode	Include
IGMPv3 IP source addresses:	
IP address 1	192.168.1.20
DSCP	Expedited Forwarding (EF)
PTP advanced settings	
Clock offset threshold	0.5 sample
Slave clock sensitivity	500

Description of the parameters:

Parameter	Read/Write	Meaning
Transport	R/W	Allows specifying if the PTP clock is unicast or multicast.
Domain number	R/W	PTP clock domain number (from 0 to 128)
Mechanism	R/W	<p>Syntonized: means that IQOYA's clock is the same as the Grandmaster PTP, but they are not synchronous (delay between the two clocks). Synchronous clock is obtained thanks to E2E or P2P modes, which serve to compensate the delay between Grandmaster PTP clock and IQOYA.</p> <p>E2E is a more universal setting (it consists of requests and answers between the node (IQOYA) and the Grandmaster PTP clock unit).</p> <p>P2P provides higher clock sync precision but requires full PTP support from all participating switches (between IQOYA and related clock master.)</p> <p>In case the PTP clock is generated by an IQOYA, the PTP mechanism must be the same as in the IQOYA master: syntonized.</p>
Network interface	R/W	Select the network interface that receives the PTP
IGMPv3 filtering mode	R/W	<p>Off: X/LINK subscribes to the multicast PTP clock which can be generated by any source IP address.</p> <p>Include: X/LINK subscribes to the multicast PTP clock which is generated only by the listed source IP addresses.</p> <p>Exclude: X/LINK subscribes to the multicast PTP clock which is generated by any source IP address, with exception of the listed IP addresses..</p>
IGMPv3 IP source addresses		
IP address x	R/W	Allows declaring the source IP addresses to be included or excluded. Click on  to add an IP@ to the list.
DSCP	R/W	QoS assigned to the PTP frames. Select the value from the drop down list. For optimal QoS on PTP, "Expedited forwarding (EF)" value is recommended.
PTP advanced settings		
Clock offset threshold	R/W	This parameter defines the condition for being synchronized to the PTP clock. The lower the value, the better the phase with the PTP clock. Lower values require a deterministic network. For networks that introduce an erratic jitter to the PTP frames, the value must be increased. Default value is 0.5 sample. It can be increased up to 64 samples.

Slave clock sensitivity	R/W	It defines the sensibility of the slave clock to the PTP packet jitter. Enter a value between 500 (for a high sensitivity) and 100 (for a low sensitivity). Default value is 500
-------------------------	-----	--

The *clock offset distribution* section displays information about the received PTP clock.

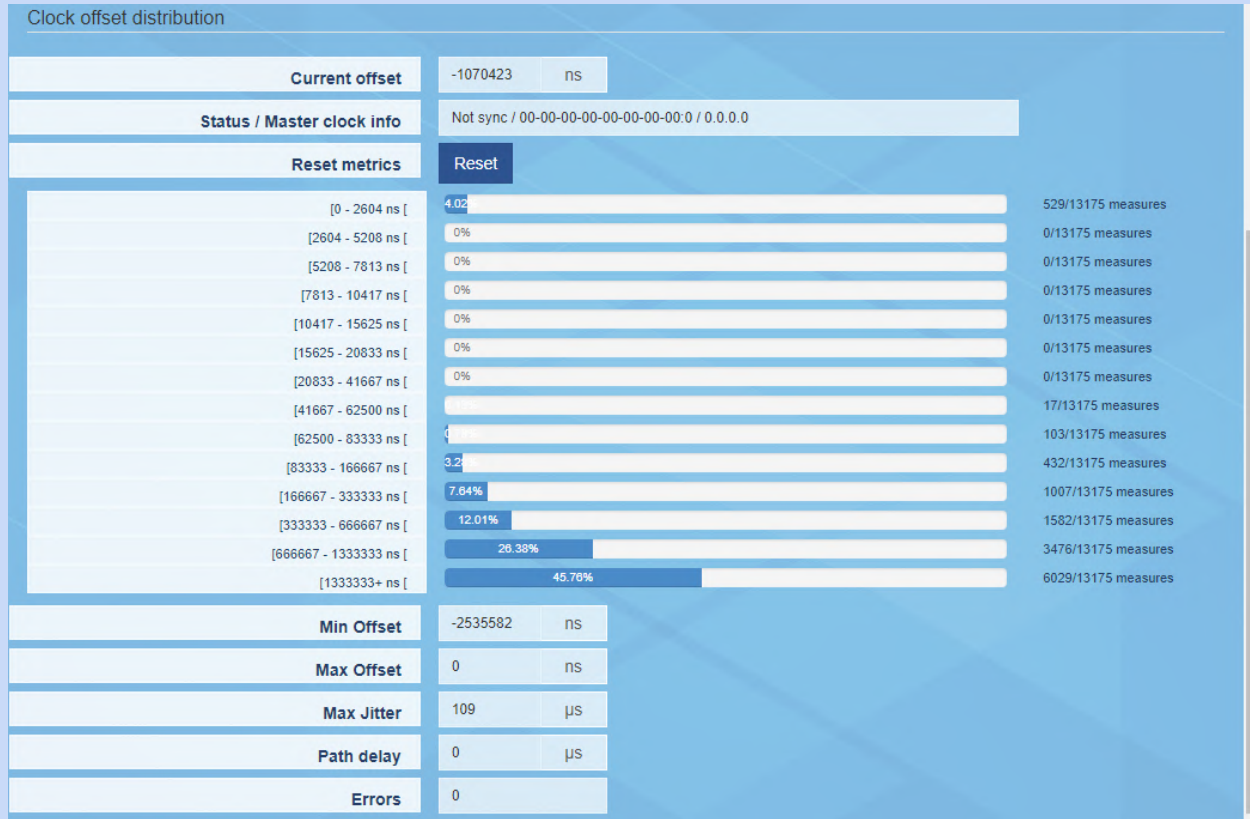

8.2.3.1.2.2 Livewire (Slave)

The following parameters appear when the mode “Livewire Slave” is selected:

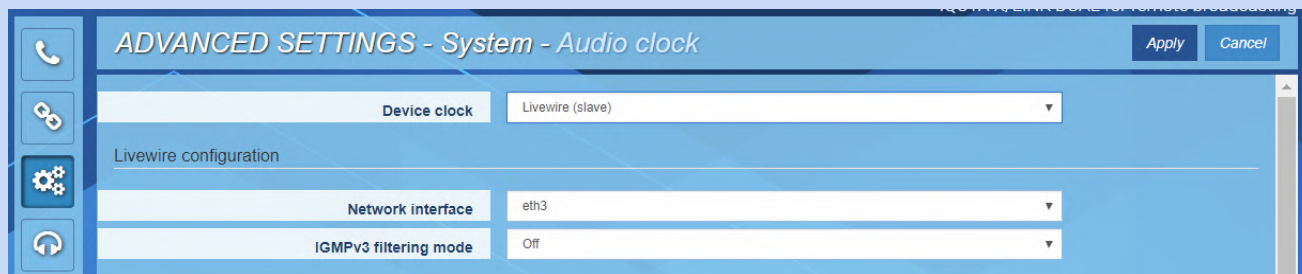

Description of the parameters:

Parameter	Read/Write	Meaning
-----------	------------	---------

Network interface	R/W	Select the network interface that receives the livewire clock.
IGMPv3 filtering mode	R/W	Off: X/LINK subscribes to the Livewire clock which can be generated by any source IP address. Include: X/LINK subscribes to the Livewire clock which is generated only by the listed source IP addresses. Exclude: X/LINK subscribes to the Livewire clock which is generated by any source IP address, with exception of the listed IP addresses..
IGMPv3 IP source addresses		
IP address x	R/W	Displayed if IGMPv3 filtering mode is set to “Exclude” or “Include”. Allows declaring the source IP addresses to be included or excluded. Click on  to add an IP@ to the list.

The *clock offset distribution* section displays information about the received Livewire clock.

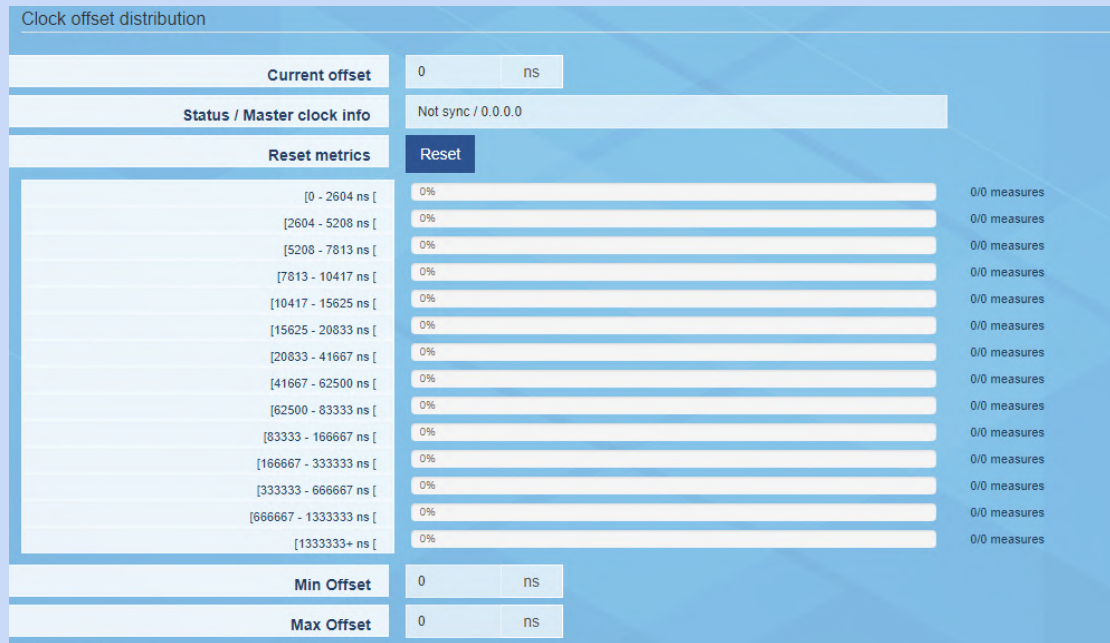

Click on “Apply” to confirm your choice.

8.2.3.1.3 Advanced settings -> System -> Audio setup

This page allows setting the processing granularity and the working sampling frequency:

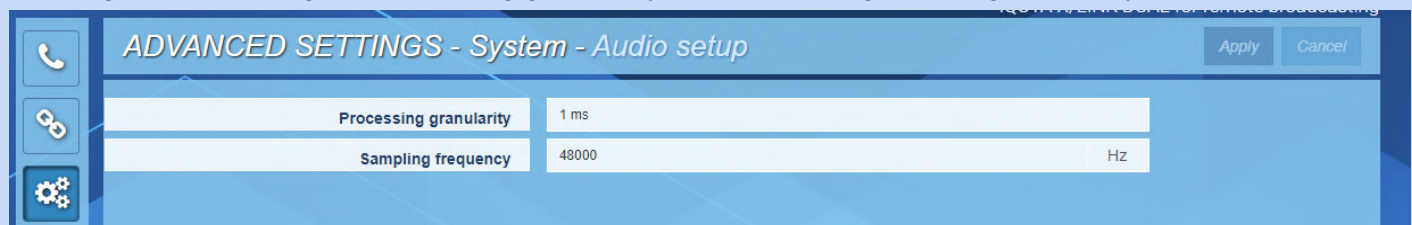

Click on a parameter field to be able to change the values.

Parameter	Description
<i>Processing granularity</i>	This is the smallest amount of data processed at a time by IQOYA. The lower the processing granularity, the lower the latency. Possible values are 1ms, 2ms, 3 ms, 4 ms. However, a value of 1ms may lead to audio underruns, depending on the features enabled on IQOYA. In case this happens, it is necessary to increase the processing granularity value. Note: the payload size of an IP frame is adjustable via parameter Payload size, from the Send page (see paragraph Encoder parameters configuration).
<i>Sampling frequency</i>	It defines the working sampling frequency of IQOYA. Note that received and generated IP streams can carry audio at a different sampling frequencies (in which case a high quality frequency change is applied). When sampling frequency is set to 48 kHz, IP streams can be at 48 kHz, 32 kHz, 16 kHz (G722), and 8 kHz (G711). Note that 44.1 kHz is allowed for a HTTP stream. When sampling frequency is set to 44.1 kHz, IP streams must be at 44.1 kHz.

Click on “Apply” to confirm your changes.

8.2.3.1.4 Advanced settings -> System -> Logs

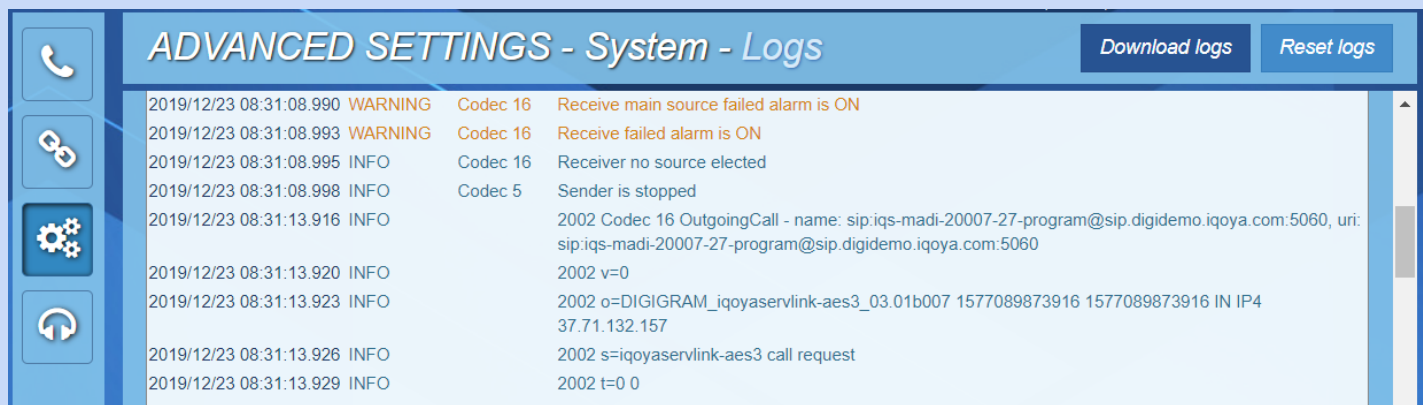

This page allows viewing and downloading the log file of IQOYA X/LINK. This log file gives information about the internal behaviour of IQOYA, and is useful for advanced diagnostics. Traces of enabled alarms are written into this log file (alarm ON, alarm OFF). This log file is stored internally and is persistent to a power cycle, a restart or reboot.

Event Type: allows selecting the category of traces to be displayed: Infos, Warnings, Errors, Errors & Warnings.

Codec: allows selecting one of the codecs so that only log traces related to this codec are displayed. The number of the codec can be seen from the Send/IP Services page, and from the Receive/ Programs page.

Auto refresh: The page content is refreshed automatically if this parameter is set to “Yes”.

Date & Time: clicking on this icon allows to sort out the traces by date and time, starting by most recent traces or starting by oldest traces.

Reset logs: resets all the traces.

Download logs: allows remotely downloading the log traces.

8.2.3.1.5 Advanced settings -> System -> Download / Upload

This page allows downloading the IQOYA configuration to a remote PC, or uploading a configuration from a remote PC to IQOYA.

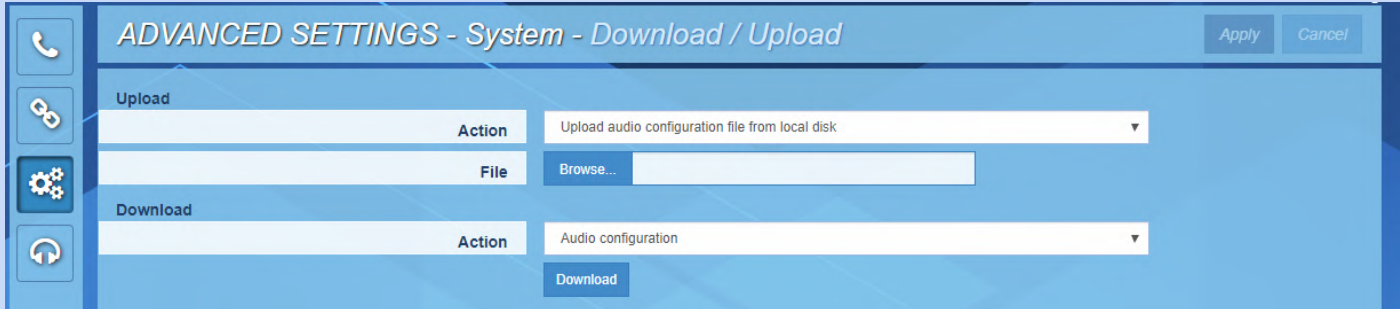

To save the current configuration of IQOYA to a remote PC, click on “ Download”.

To apply a configuration to IQOYA, click on “ Browse” to select the configuration file, and click on “Apply”.

The configuration that can be uploaded/downloaded can be:

- The audio configuration only (includes the programs and IP services)
- The full codec configuration
- The connection book: The connection book is the concatenation of the contact list and the call profile list.

In addition, the html file which allows to view all the parameters of the codec can be downloaded. From the download section, select “ Device Information”, and download.

8.2.3.1.6 Advanced settings -> System -> SD card

This page allows:

- mounting an SDHC card if it is inserted while the unit is running,
- unmounting it before removing it from the front panel.
- Viewing the SDHC card status: mounted/unmounted

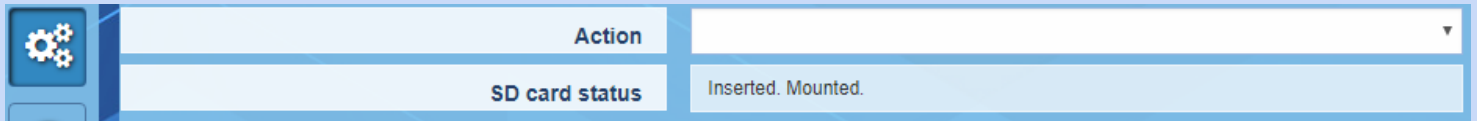

8.2.3.1.7 Advanced settings -> System -> SD card backup

The codec configuration can be saved to SDHC card or loaded from it.

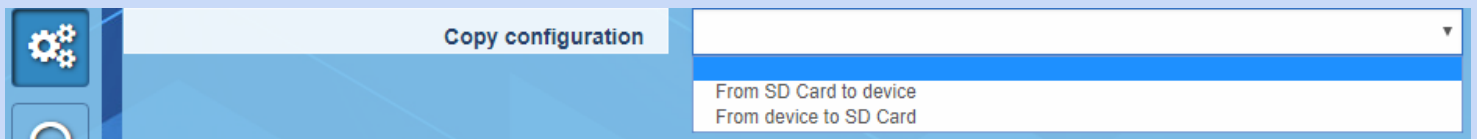

- From the “Copy configuration” field, select whether the configuration has to be copied from the SDHC card to IQOYA’s internal memory or from the internal memory to the SDHC card.

Notes:

- Audio activity is stopped when the configuration is loaded from the SDHC card.
- The unit is restarted to apply the new configuration.
- On the SDHC card, the configuration file “IQOYA_Configuration_save.tar” is stored in folder \IQOYA_LINK\Config.
- The current configuration of the IQOYA codec can also be displayed from a WEB browser by selecting the file \IQOYA_LINK\ Config.html, accessible via FTP.
- The configuration saved on the SDHC card can be loaded from the IQOYA X/LINK front panel LCD display and keyboard (menu System)
- This configuration on SDHC card can also be loaded when starting IQOYA with the SD card inserted. The file “/SDCARD/iqoya_link/run_once/ boot_commands.txt” must contain the following line: `RESTORE_FULLCONFIG_FROMSD=Yes`

8.2.3.1.8 Advanced settings -> System -> Firmware & License update

IQOYA can be updated with a new firmware, a patch, or an optional license. The first phase of the update consists in uploading and checking the software package; during this phase, the audio activity is not stopped. The second phase consists in applying the uploaded package; audio activity is stopped during this phase. Two firmware versions are stored locally: the currently running version, and the previous version. This allows to go back to the previous firmware version if an issue is experienced with the more recent version, without having to go through an upload.

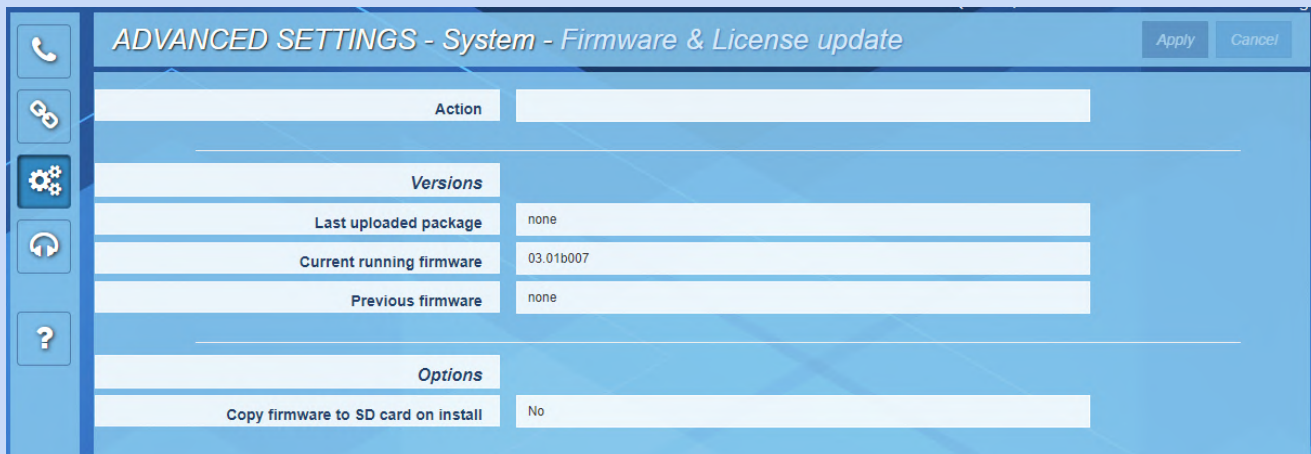

Click on the “Action” field, and click on the arrow to display the list of possible actions.

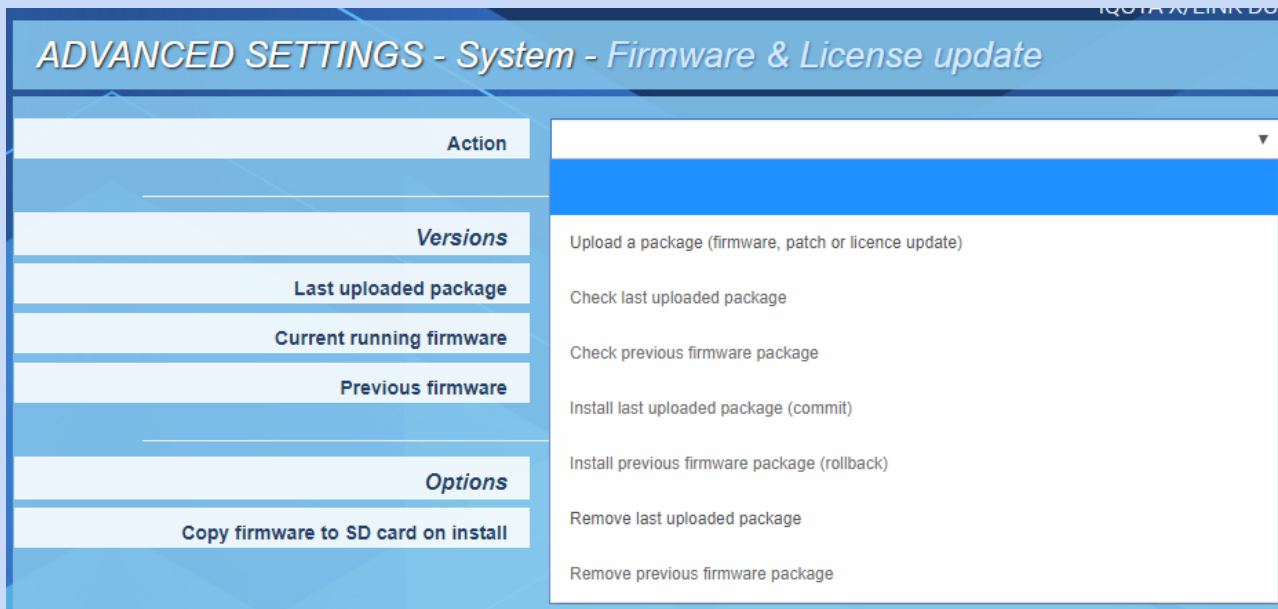

The screenshot shows a web interface titled "ADVANCED SETTINGS - System - Firmware & License update". On the left, there is a sidebar with several sections: "Action", "Versions", "Last uploaded package", "Current running firmware", "Previous firmware", "Options", and "Copy firmware to SD card on install". The "Action" section is currently selected, and a dropdown menu is open to its right. The dropdown menu contains the following options: "Upload a package (firmware, patch or licence update)", "Check last uploaded package", "Check previous firmware package", "Install last uploaded package (commit)", "Install previous firmware package (rollback)", "Remove last uploaded package", and "Remove previous firmware package".

Select the appropriate action through the list.

For a firmware update, select “Upload a package”, and click on “Browse” to select the file to be uploaded.

Click on “Apply” to start the upload. Audio activity is not stopped during the upload.

Once the package upload is completed, select the action “Install last uploaded firmware”, and click on “Apply”.

Applying the firmware stops the audio activity. The equipment restarts automatically.

The following operations are also possible from the “Action” drop-down menu:

- **Check previous firmware package:** this allows checking that the previous firmware version that is stored locally is correct.
- **Check last uploaded package:** this allows checking that the last uploaded firmware version is correct. This operation is done automatically during the upload phase.
- **Install previous firmware package (rollback):** this allows installing a previous version of the firmware that is stored locally. This is a firmware downgrade.
- **Remove last uploaded package:** this allows deleting the last uploaded package. This means that this package will not be installed.
- **Remove previous uploaded package:** this allows deleting the previous uploaded package. This means that an upload is necessary for a firmware downgrade.

Copy firmware to SD card on install

Set to Yes, this parameter allows copying to the SD card the firmware to be installed to facilitate a future possible firmware rollback. Exemple:

- Firmware to be upload and applied: version A
- Copy to SD card set to Yes
- Firmware to upload and applied: version B

- Copy to SD card set to Yes
=> Current firmware = version B / Previous firmware = version A
At this point version A can be re-installed without the upload phase.

8.2.3.1.9 Advanced settings -> System -> Password

This page allows changing the username and password for a given user category. This can be done when logged to the IQOYA as Administrator.

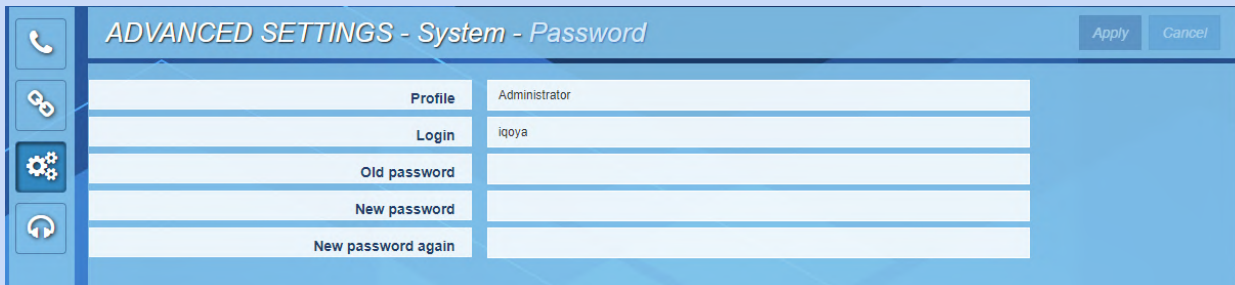

First select the profile for which credentials have to be changed.

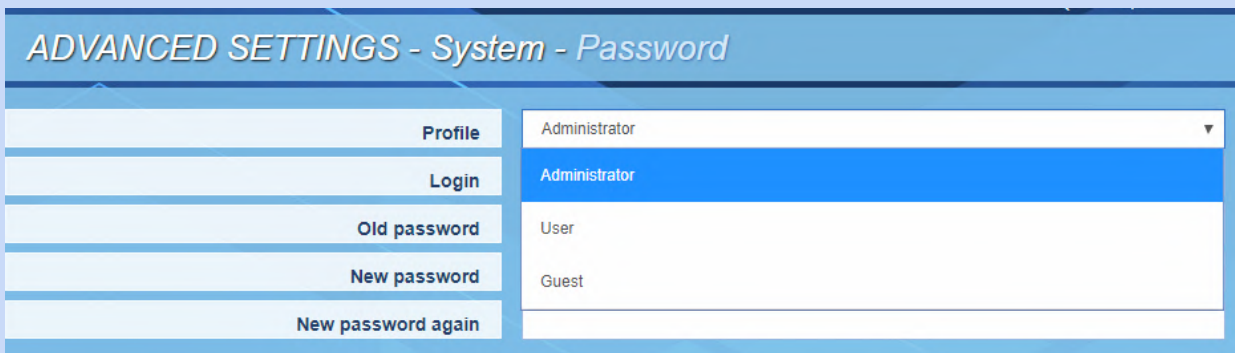

Login: allows configuring the username to be used in order to log to the WEB GUI with the selected profile.

Old password: Type the current password

New password: Type the new password

New password again: confirm the new password

Click on "Apply" to confirm the changes.

8.2.3.1.10 Advanced settings -> System -> Shutdown / Restart

This page allow to restart or shutdown IQOYA.

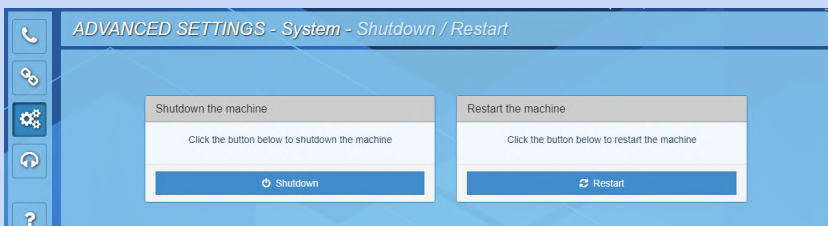

Click on the appropriate action.

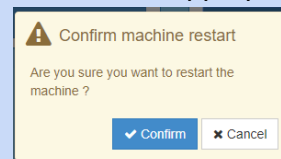

Confirm or cancel your choice through the

displayed confirmation window.

8.2.3.1.11 Advanced settings -> System -> Switch mode of use

This page allows switching from “Remote Broadcasting” mode of use to “Program Distribution” mode of use and vice versa:

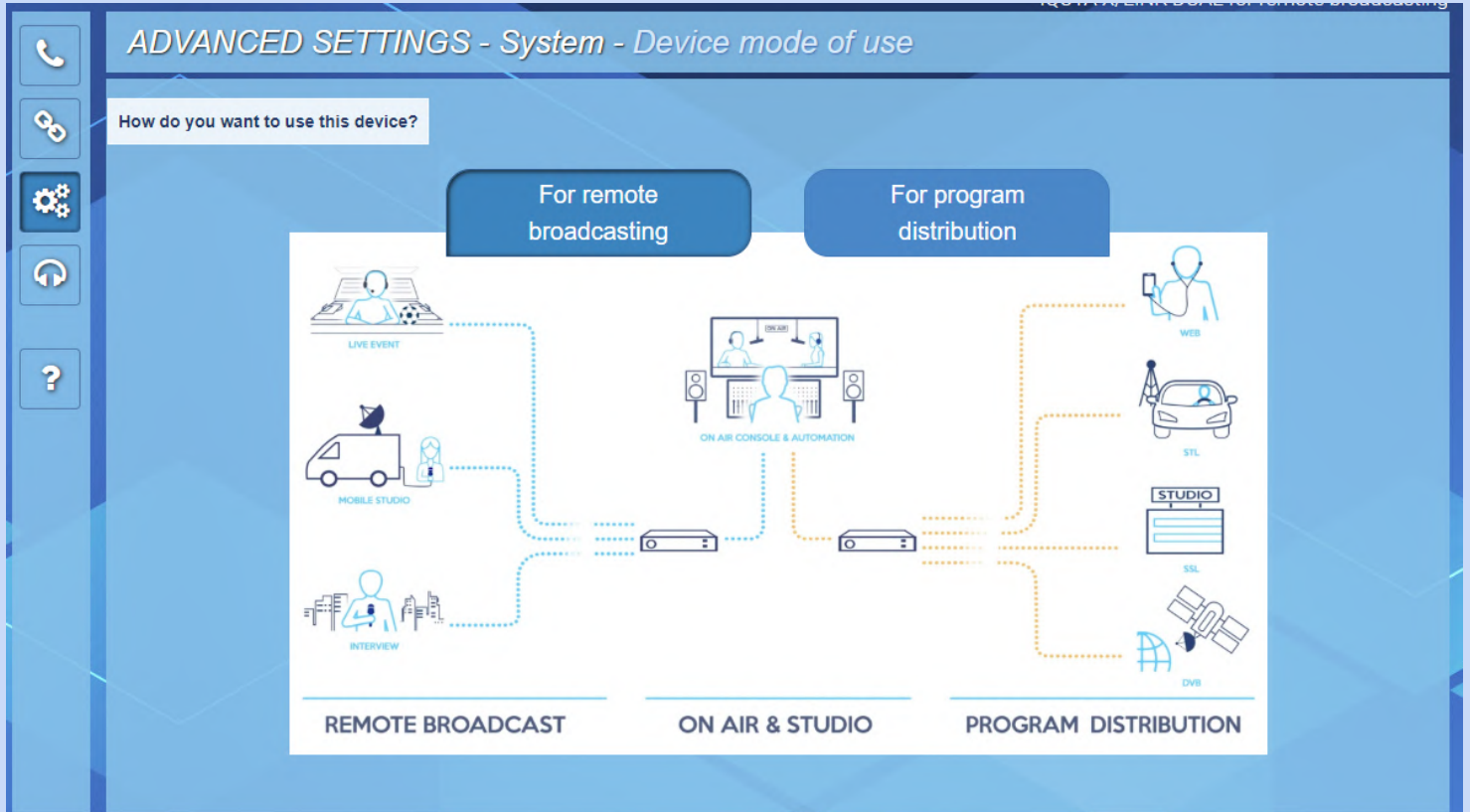

To switch to “Program Distribution” mode of use, click

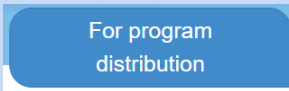

button then confirm your choice through the displayed confirmation window:

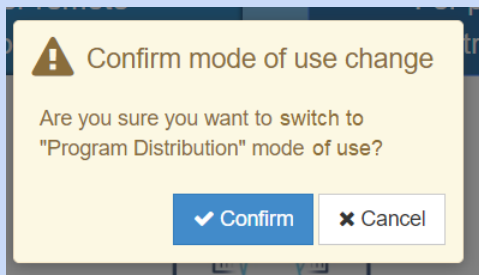

8.2.3.2 Advanced settings -> services

8.2.3.2.1 Advanced settings -> services-> NTP

This page allows:

- configuring the date and time synchronization to an NTP server.
- enabling the optional feature “audio synchronization on NTP clock”.

NTP service is disabled by default.



Click on the “**service activation**” field to activate/deactivate the NTP service. Select “Yes” to activate it. Enter then the IP address of the NTP server.

In case you just need to activate the date and time NTP synchronization, click on “Apply”. The status of the service is displayed in the field “Service status”.

For activation of the NTP based audio synchronization, select “Yes” for parameter “**Sync audio on NTP clock**”.

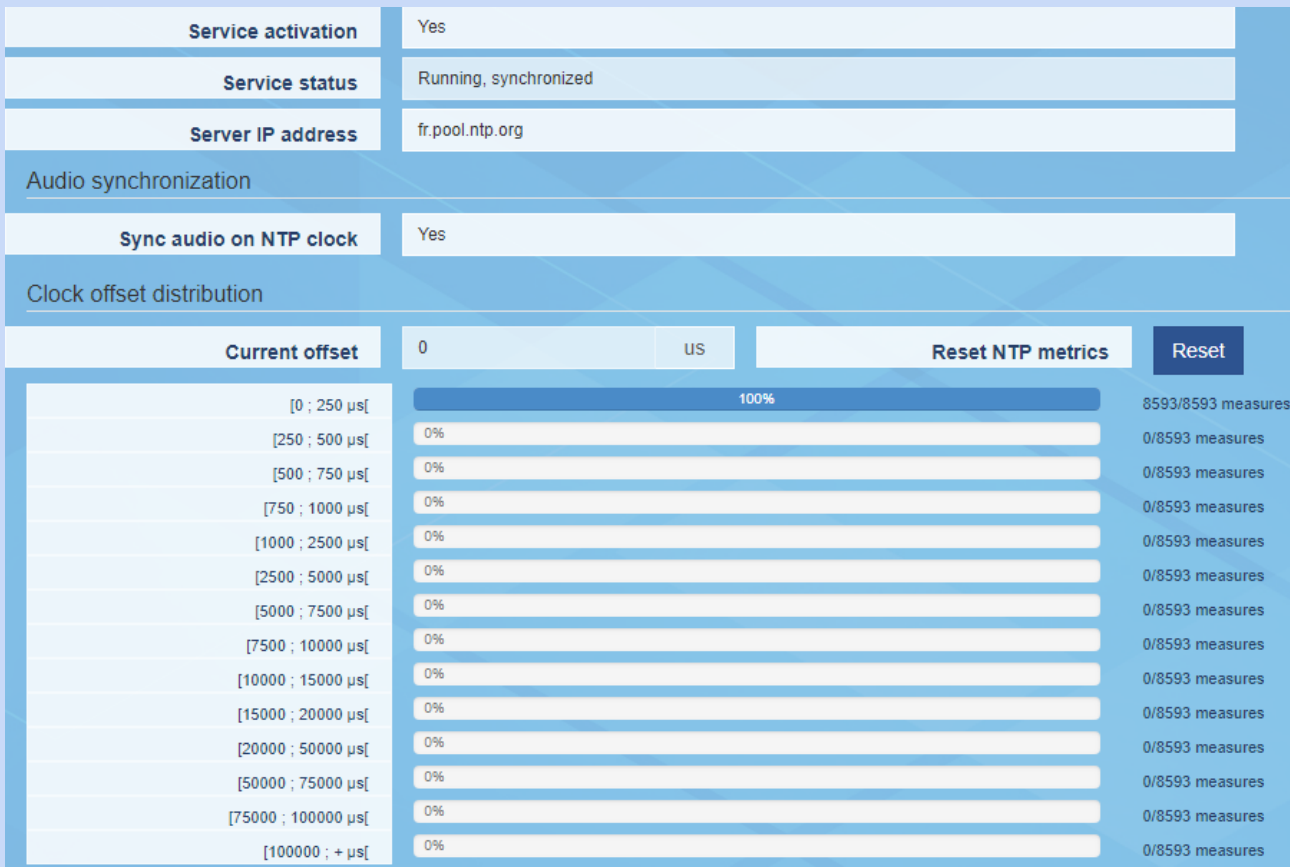

Once IQOYA is synchronized on the NTP server, the field “Service status” displays “Running, synchronized”. This requires that the software option is installed on the IQOYA X/LINK, as well as on the associated IQOYA decoders.

8.2.3.2.2 Advanced settings -> services-> FTP

FTP is useful typically for managing the backup playlists and sound files on IQOYA's internal storage (uploading/deleting).

FTP service is disabled by default.

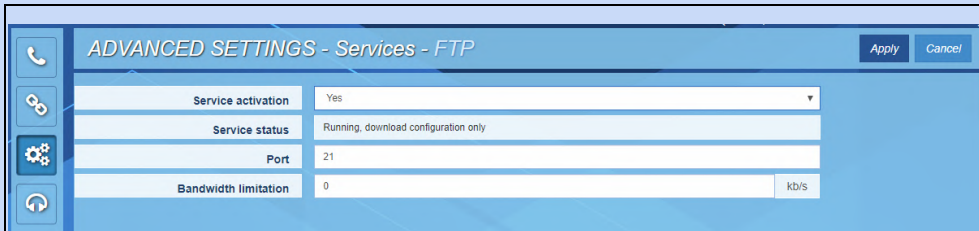

ADVANCED SETTINGS - Services - FTP	
Service activation	Yes
Service status	Running, download configuration only
Port	21
Bandwidth limitation	0 kb/s

Click on the “Service activation” field. Select “Yes” to enable the FTP service, “No” to disable it. If necessary, you may change the port used for FTP (default value is 21). Parameter “Bandwidth limitation” allows limiting the network bandwidth of the FTP traffic. Click on “Apply” to confirm the changes. Note that a username and password are required to establish an FTP connection to IQOYA X/LINK. Username is: ftp. Password is the administrator password, by default: iqoya.

Note that backup playlists and sound files have to be stored in folder `DEVICE_STORAGE`.

8.2.3.2.3 Advanced settings -> services-> SSH

This page allows enabling/disabling the SSH service on IQOYA.

SSH is mainly to be used by Digigram technical support for advanced diagnostics.

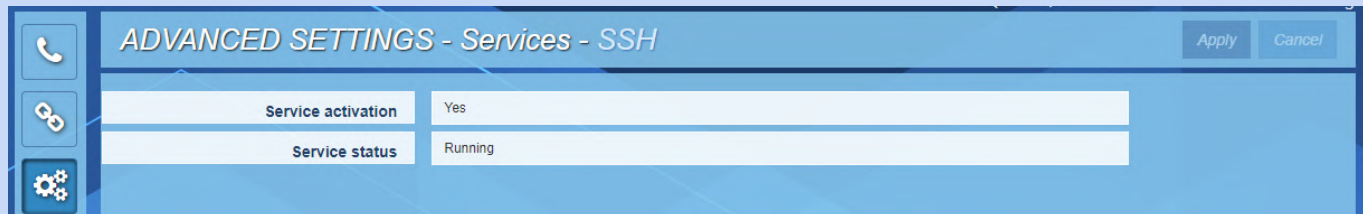

ADVANCED SETTINGS - Services - SSH	
Service activation	Yes
Service status	Running

8.2.3.2.4 Advanced settings -> services-> HTTPS

This page allows setting a bandwidth limitation to the HTTP traffic.

In case the IP audio stream takes almost all the available network bandwidth, the HTTP traffic generated when accessing the WEB pages may disturb the IP audio frames transmission, because the total bandwidth necessary for the IP audio stream plus HTTP traffic may exceed the available network bandwidth.

To avoid this problem, IQOYA offers the possibility to set a bandwidth limitation for the HTTPS traffic.

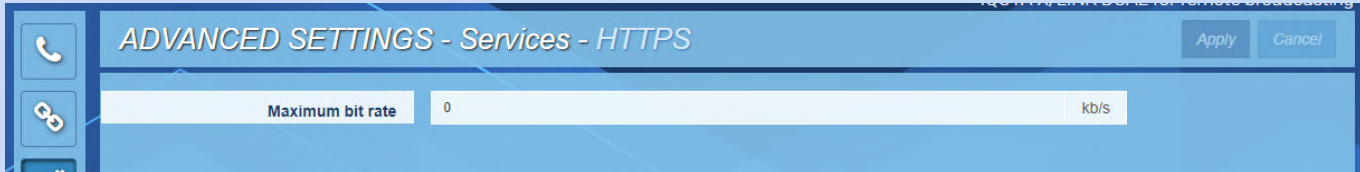

Click on the “Maximum bit rate” field, and enter the maximum bit rate allowed for HTTPS traffic.

Default value is 0, which means no limitation on HTTPS traffic.

The smaller the value, the longer it takes to load the WEB page!

Click on “Apply” to confirm the settings.

8.2.3.2.5 Advanced settings → services → Publish / Discover

This page allows enabling the automatic discovery and publishing of AES67 or RAVENNA streams.

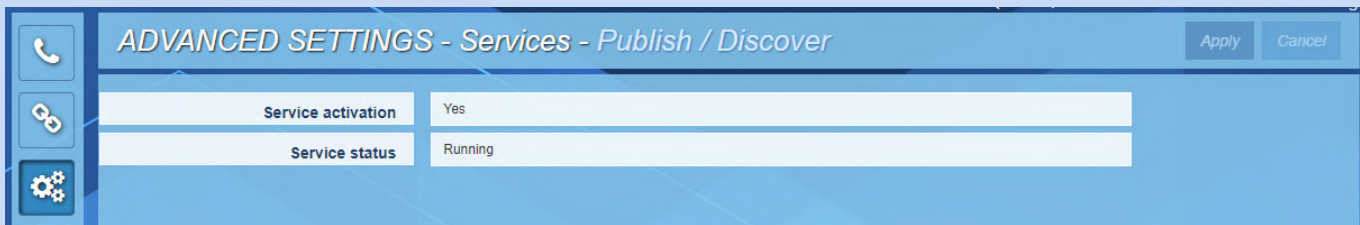

In case you do not use AES67 or RAVENNA audio I/Os, there is no need to activate this service.

8.2.4 Audio I/Os category of menus

This category of menus and the pages they allow to reach are identical in "Remote Broadcasting" mode of use and in "Program Distribution" mode of use. Please refer to their descriptions in the “Program Distribution” section of this manual, paragraph [8.1.2 Audio I/Os category of menus](#).

9 Managing sound files and playlists via FTP

Available in “Program Distribution” mode of use only.

Local sound files and playlists on the SDHC card can be uploaded and removed via FTP.

Connect to IQOYA X/LINK via an FTP software application. Login is as follows:

- username: ftp
- password: iqoya

These are default username and passwords. Note that the username and password may be changed.

Playlists (.m3u) and sound files must be stored in folder “SDCARD”.

10 Specifications

10.1 IQOYA X/LINK-LE and X/LINK-ST

10.1.1 CONFIGURATION

Dimensions	19", 1RU
Weight	~ 3.1 kg (~6.85 lbs)
Power supply	2 internal redundant PSU 100-250VAC, Optional: 100-250VAC / -48VDC
Temperature / Humidity non-condensing	Operating: 0°C – 50°C / 0% – 95% Storage: -5°C – 70°C / 0% – 95%
Power consumption	Max 21W

10.1.2 CONNECTIVITY

	X/LINK-ST X/LINK-LE	X/LINK-DUAL	X/LINK-AES67
WAN / LAN Ethernet ports	1 x 100 Mbps (Eth2) + 3 x 10/100/1000 Mbps RJ-45 (Eth1, 3,4)		
Analog and AES/EBU audio inputs	Female XLR on breakout cables		
Analog and AES/EBU audio outputs	Male XLR on breakout cables		
Serial data	1 x RS232 port Sub-D 9		
GPIO's	8 Opto-Isolated GPIs (4 with <i>factory option "Sync option for X/LINK"</i>) 8 relay GPOs (4 with <i>factory option "Sync option for X/LINK"</i>): : - 3 SPDT outputs: common, norm. open, .norm. closed - max 220 VDC/250 VAC, - max 60 W, 62.5 VA - max. continuous/switching current: 2 A/3 A	4 Opto-Isolated GPIs 4 relay GPOs: : - 3 SPDT outputs: common, norm. open, .norm. closed - max 220 VDC/250 VAC, - max 60 W, 62.5 VA - max. continuous/switching current: 2 A/3 A	8 Opto-Isolated GPIs (4 with <i>factory option "Sync option for X/LINK"</i>) 8 relay GPOs (4 with <i>factory option "Sync option for X/LINK"</i>): : - 3 SPDT outputs: common, norm. open, .norm. closed - max 220 VDC/250 VAC, - max 60 W, 62.5 VA - max. continuous/switching current: 2 A/3 A

10.1.3 ANALOG INPUTS

	X/LINK X/LINK-LE	X/LINK-DUAL	X/LINK-AES67
Type	2 balanced	4 balanced	-
A/D converter resolution	24 bits		-
Maximum level/ impedance	+24 dBu/ >10 k Ω		-
Adjustable gain	From -94.5dB to +24 dB; 0.5 dB steps Maximum sensitivity: 0 dBu input signal -> 0 dBfs		-
Adjustable digital gain	From -15 dB to +15 dB; 0.1 dB steps		-

10.1.4 ANALOG LINE OUTPUTS

	X/LINK X/LINK-LE	X/LINK-DUAL	X/LINK-AES67
Type	2 Line balanced	4 Line balanced	-
D/A converter resolution	24 bits		-
Maximum input level/ impedance	+24 dBu/ <100 Ω		-
Adjustable analog gain	From -94.5dB to +24 dB; 0.5 dB steps		-
Adjustable digital gain	From -15 dB to +15 dB; 0.1 dB steps		-

10.1.5 AES/EBU INPUTS

	X/LINK X/LINK-LE	X/LINK-DUAL	X/LINK-AES67
Type	1 balanced. Zin = 110 Ohms	2 balanced. Zin = 110 Ohm	-
Hardware sample rate converters	Sample rate conversion = 7.5:1 to 1:8, up to 192 kHz		-
Adjustable digital gain	from -15 dB to +15 dB		-

10.1.6 AES/EBU OUTPUTS

	X/LINK X/LINK-LE	X/LINK-DUAL	X/LINK-AES67
Type	1 balanced. Zout = 110 Ohms	2 balanced. Zout = 110 Ohms	-
Sample rate	32 kHz, 44.1 kHz, or 48 kHz		-

10.1.7 AES67/RAVENNA

	X/LINK X/LINK-LE	X/LINK-DUAL	X/LINK-AES67
Inputs / outputs	2 mono channels (1 stereo)	4 mono channels (2 stereo)	2 mono to 16 mono (1 stereo to 8 stereo)
Sample rate	44.1 kHz, or 48 kHz		
PTP slave	Yes		
PTP Master	Yes		
Clock source	PTPv2 (IEEE1588-2008) from network or internal clock or Word Clock or local clock eligible as GrandMaster PTP		
Samples per packet	48 / 192		
Audio payload formats	PCM16 / PCM24 / PCM32 / AM824 (PCM24+AES3 channel status)		

10.1.8 Livewire

	X/LINK X/LINK-LE	X/LINK-DUAL	X/LINK-AES67
Inputs / outputs	2 mono channels (1 stereo)	4 mono channels (2 stereo)	2 to 16 mono channels (1 to 8 stereo)
Sample rate	48 kHz		
Mode	Standard (240 samples)	Standard (240 samples)	Standard (240 samples)

10.1.9 HEADPHONES OUTPUT

	X/LINK X/LINK-LE	X/LINK-DUAL	X/LINK-AES67
--	---------------------	-------------	--------------

Type	1 balanced (6.35mm jack)
Power	max 2x50 mW / 2x32 ohms load

10.1.10 OTIONAL SYNCHRONIZATION INPUTS

	X/LINK X/LINK-LE	X/LINK-DUAL	X/LINK-AES67
10 MHz / 1 PPS	BNC connectors on breakout cable		

10.1.11 ANALOG AUDIO PERFORMANCES

Frequency response	20 Hz-20 kHz +/- 0,1 dB at 48 kHz
Signal to Noise	>108 dBA
Dynamic range (A-weighted)	Analog In: >104 dB / Analog Out: >106 dB
THD + noise 20-20kHz at -1 dBfs	<-90 dB
Channel phase difference: 20/20kHz	0.1° / 0.27°
Crosstalk (Analog in or out) 1 kHz at 22 dBu	1 kHz: < -120 dB 10 kHz: <-110 dB 20 kHz: <-107 dB
Internal clock precision	Better than 10 PPM

11 APPENDIX C: GPIO's CONNECTORS

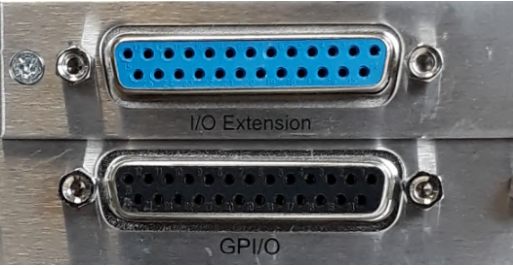
	<p>IQOYA X/LINK codecs provide four of eight GPIOs and GPOs on two female Sub-D 25 connectors. The lower connector named "GPIO" provides 4 GPIO's.</p> <p>The upper connector named "I/O Extension" provides 4 additional GPIO's (except on X/LINK-DUAL), when it is not used for other types of I/Os</p>
--	---

GPIO pinout

Upper Sub-D 25

Pin	13	12	11	10	9	8	7	6	5	4	3	2	1
GPIO	-	-	-	GPO_4	GPI_4	GPO_3	GPO_3	-	GPO_2	GPI_2	GPO_1	GPO_1	-
Label	unused	GND	GND	N.C.	K	N.O.	COM	unused	N.C.	K	N.O.	COM	unused

Pin	25	24	23	22	21	20	19	18	17	16	15	14
GPIO	-	-	GPO_4	GPO_4	-	GPO_3	GPI_3	GPO_2	GPO_2	-	GPO_1	GPI_1
Label	unused	GND	N.O.	COM	unused	N.C.	K	N.O.	COM	unused	N.C.	K

Lower Sub-D 25

Pin	13	12	11	10	9	8	7	6	5	4	3	2	1
GPIO	-	-	-	GPO_8	GPI_8	GPO_7	GPO_7	-	GPO_6	GPI_6	GPO_5	GPO_5	-
Label	unused	GND	GND	N.C.	K	N.O.	COM	unused	N.C.	K	N.O.	COM	unused

Pin	25	24	23	22	21	20	19	18	17	16	15	14
GPIO	-	-	GPO_8	GPO_8	-	GPO_7	GPI_7	GPO_6	GPO_6	-	GPO_5	GPI_5
Label	unused	GND	N.O.	COM	unused	N.C.	K	N.O.	COM	unused	N.C.	K

- GND:** connected to ground
- N.C.:** contact normally closed
- N.O.:** contact normally open
- COM:** common contact
- unused:** not used, DO NOT CONNECT!
- K:** optocoupler cathode

General Purpose Inputs (GPIs)

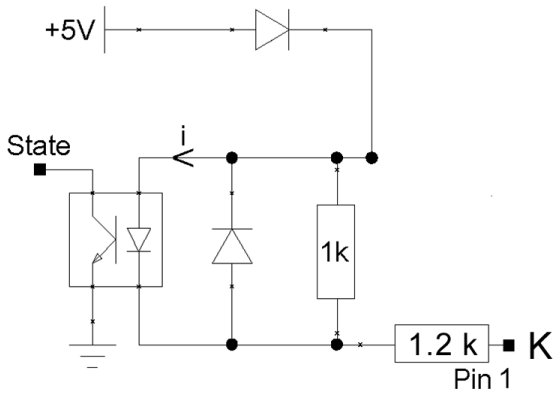

The IQOYA X/LINK GPI's are compatible TTL 5 V.

They do not require any external power.

GPI status is "open" (1) when pin K is not connected to the ground for at least 20ms.

GPI status is "closed" (0) when pin K is connected to the ground for at least 20ms. (ground is on pins 11-12-24 on the upper Sub-D connector, and pins 10-12-24 on the lower Sub-D

connector).

GPI optocoupler specifications

Minimum current i_{min} to switch GPI	1 mA
Maximum current i_{max} supported	60 mA
Maximum voltage V_K supported	11 V _{DC}

General Purpose Outputs (GPOs)

The IQOYA X/LINK GPO's are opto-isolated SPDT type relays (Single Pole, Double Throw).

Each GPO features 3 pins:

- COM : Common
- N.C. : normally closed
- N.O. : normally open

According to the status applied to the GPO, pin N.C. is connected to pin COM, or pin N.O. is connected to pin COM.

GPIO tunneling in direct mode (status not inverted)

When GPI tunneling is enabled, an open GPI (pin K not connected to the ground) is reflected on the distant GPO by pin N.O connected to pin COM.

GPIO tunneling in inverted mode (status inverted)

An “open” GPI (pin K not connected to the ground) is reflected on the distant GPO by pin N.O connected to pin COM. Pin N.C is left unconnected.

A “closed” GPI (pin K connected to the ground) is reflected on the distant GPO by pin N.C. connected to pin COM. Pin N.O is left unconnected.

Alarms notification

Alarms can also be notified on GPOs. See chapter “Alarms management”.

GPO relay specifications

Maximum power switching capability	60 W/62.5 VA
Maximum switching current	5 A _{DC}
Maximum carrying current	2 A _{DC}
Maximum switching voltage*	220 V _{DC} /0.24A-60 W 250 V _{AC} /0.25-62.5 V _{AC} 125 V _{AC} /0.5A-62.5 V _{AC} 30 V _{DC} /2 A-60 W
Typical life expectancy (switching max power)	10 ⁶ operations

*** Note: The maximum voltage makes it possible to control devices (up to 60 W. max) directly through the power outlet.**

12 APPENDIX D: SERIAL PORT (RS232 ON DB9)

Pin	Description
1	Not connected
2	RxD (received data)
3	TxD (transmitted data)
4	Not connected
5	Signal ground
6	Not connected
7	RTS (request to send)
8	CTS (clear to send)
9	Not connected

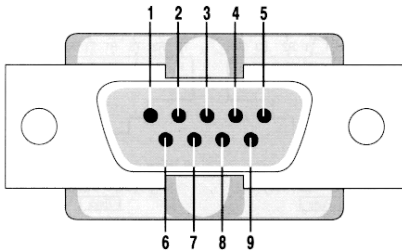

IQOYA X/LINK codecs provide an RS232 serial port on a male DB-9 connector on the back panel. Use this port to connect any compatible device. For pinout allocation details, please refer to the figure and table above.

The port may be used for tunneling serial data between encoder and decoder (RDS data, commands). Set-up is done through a web browser .

13 APPENDIX E: TYPICAL LATENCY VALUES

The back to back latency between two IQOYA X/LINK devices depends on the selected audio format, the network quality, and the enabled functionalities (backup, half/full duplex, FEC).

See the table underneath for maximum latency values in half-duplex, using neither failover configurations nor FEC, with the jitter buffer size set to 0, and with an optimized network.

Audio Type	Audio format	Latency (processing granularity set to 1ms)	Description
PCM	24 bit	9ms	
MPEG Layer II	256 kbps	90ms	
MPEG Layer III	128 kbps	152ms	
AAC-4 LC	256 kbps	105ms	
AAC-4 LC+SBR	96 kbps	210ms	aka HEv1
AAC-4 LC+SBR+PS	56 kbps	251ms	aka HEv2
AAC-4 LD	160 kbps	51ms	
AAC-4 ELD	160 kbps	45ms	
Opus	256 kbps	73ms	

All measurements taken on stereo samples at 48 kHz

Impact of the processing granularity

Add about 4 ms to the latency each time the processing granularity is increased of 1ms.

Impact of the network on latency

Latency highly depends on the quality of the network. Network jitter and packets loss typically have a direct impact on latency.

- Network jitter compensation is achieved by buffering audio data on the decoder. A good quality network generally offers a low jitter, then requiring low buffering on the decoder, which means a low increase of latency. But a network with a high jitter requires increasing the decoder buffering accordingly, leading to a significant increase of latency.
- In case of packets loss on the network, it is necessary to enable an FEC, which allows recovering lost packets thanks to redundant frames. FEC increases the latency.

Impact of features on the latency

The amount of features used in IQOYA directly impacts the latency. For a given audio format, the lowest latency is obtained in half duplex mode, with no backup defined and no FEC. As soon as one of these features is used, the latency increases a bit.

APPENDIX F: AAC SETTINGS FOR STEREO SAMPLES

AAC type	Sampling frequency (Hz)	Audio bit rate (bit/s)	IP stream bit rate (bit/s)
AAC-LC	16000	32000 – 39999	8250+ Audio bit rate
AAC-LC	22050	32000 – 39999	11369+ Audio bit rate
AAC-LC	24000	32000 – 39999	12375+ Audio bit rate
AAC-LC	32000	40000 – 320000	16500+ Audio bit rate
AAC-LC	44100	40000 – 320000	22739+ Audio bit rate
AAC-LC	48000	40000 – 320000	24750+ Audio bit rate

HE-AACv1 (SBR)	16000		
HE-AACv1 (SBR)	22050		
HE-AACv1 (SBR)	24000		
HE-AACv1 (SBR)	32000	24000 – 96000	8250+ Audio bit rate
HE-AACv1 (SBR)	44100	24000 – 96000	11369+ Audio bit rate
HE-AACv1 (SBR)	48000	24000 – 96000	12375+ Audio bit rate

HE-AACv2 (SBR+PS)	16000		
HE-AACv2 (SBR+PS)	22050		
HE-AACv2 (SBR+PS)	24000		
HE-AACv2 (SBR+PS)	32000	14000 – 56000	8250+ Audio bit rate
HE-AACv2 (SBR+PS)	44100	18000 – 56000	11369+ Audio bit rate
HE-AACv2 (SBR+PS)	48000	18000 – 56000	12375+ Audio bit rate

AAC type	Sampling frequency (Hz)	Audio bit rate (bit/s)	IP stream bit rate (bit/s)
AAC-LD	16000		
AAC-LD	22050		
AAC-LD	24000	80000 – 111999	24750 + Audio bit rate
AAC-LD	32000	112000 – 320000	33000 + Audio bit rate
AAC-LD	44100		45478 + Audio bit rate
AAC-LD	48000		49500 + Audio bit rate

AAC-ELD	16000		
AAC-ELD	22050		
AAC-ELD	24000	64000 – 97999	24750 + Audio bit rate
AAC-ELD	32000	64000 – 135999	33000 + Audio bit rate
AAC-ELD	44100	76000 – 256000	45478 + Audio bit rate
AAC-ELD	48000	98000 – 256000	49500 + Audio bit rate

AAC-ELD + SBR	16000		
AAC-ELD + SBR	22050		
AAC-ELD + SBR	24000		
AAC-ELD + SBR	32000		
AAC-ELD + SBR	44100	48000 – 96000	45478 + Audio bit rate
AAC-ELD + SBR	48000	48000 – 96000	49500 + Audio bit rate

14 APPENDIX H: AVAILABLE FEC

FEC (Forward Error Correction) is a mechanism which consists in sending redundant information (redundant frames) to the decoder so that it can compensate packet transmission errors on unreliable networks.

An FEC can be selected when defining the parameters of the stream to be generated (Send page) and/or to be received (Receive page).

FEC requiring no additional stream

Redundant frames are sent in the same stream as the IP audio stream.

The FEC to be selected is “**+50% bandwidth, recovery 2, 1 stream (audio)**”.

Its characteristics are: +50% bandwidth, additional delay of 2 frames, recovers 1 lost packet at 100%, recovers 2 consecutive lost packets at 75%.

FEC requiring an additional stream

Standard FECs

Redundant frames are sent as a second stream of data. The used UDP port is: port of the IP audio stream + 2.

Selectable FECs are:

- **+100% bandwidth, recovery 3, 2 streams (audio + FEC)**
+100% bandwidth, additional delay of 1 frame, recovers 2 consecutive lost packet at 100%, recovers 3 consecutive lost packet at 75%
- **+100% bandwidth, recovery 4, 2 streams (audio + FEC)**
+100% bandwidth, additional delay of 3 frames, recovers 3 lost packet at 100%, recovers 4 consecutive lost packet at 80%
- **+50% bandwidth, recovery 1/2, 2 streams (audio + FEC)**
+50% bandwidth, additional delay of 1 frame, recovers 1 lost packet over 2 consecutive packets.
- **+33% bandwidth, recovery 1/3, 2 streams (audio + FEC)**
+33% bandwidth, additional delay of 2 frames, recovers 1 lost packet over 3 consecutive packets.
- **+25% bandwidth, recovery 1/4, 2 streams (audio + FEC)**
+25% bandwidth, additional delay of 3 frames, recovers 1 lost packet over 4 consecutive packets.
- **+20% bandwidth, recovery 1/5, 2 streams (audio + FEC)**
+20% bandwidth, additional delay of 4 frames, recovers 1 lost packet over 5 consecutive packets.
- **+10% bandwidth, recovery 1/10, 2 streams (audio + FEC) – From firmware 2.31**
+10% bandwidth, additional delay of 9 frames, recovers 1 lost packet over 10 consecutive packets.

Redundant dual streaming

Redundant dual streaming is activated by selecting an appropriate “Dual stream” FEC. A dual stream FEC consists in considering the redundant stream as an FEC.

In addition, the duplicated stream can be delayed to offer time diversity, thus avoiding that a network disturbance affects the same frames on the primary stream and on the FEC stream. Selectable delay is from 0 to 3000 ms, by steps of 100 ms.

Notes:

- When in-band audio format signaling is enabled, FEC stream is sent to the same IP address as the primary stream, and on UDP port + 2.
- When in-band audio format signaling is disabled, it is possible to define the destination address and port of the FEC stream.

15 APPENDIX I: REDUNDANT DUAL STREAMING

Spatial diversity

IQOYA X/LINK can be configured to send the same AoIP stream on two distinct networks, typically through Eth0 and Eth1 interfaces. On the decoding side, IQOYA automatically synchronizes both received streams. Using separate network paths ensures that potential network failures are statistically uncorrelated, enabling the reconstruction of a unique unperturbed stream.

Terminology used for the two redundant streams is: primary stream, and FEC “dual” stream for the duplicate stream.

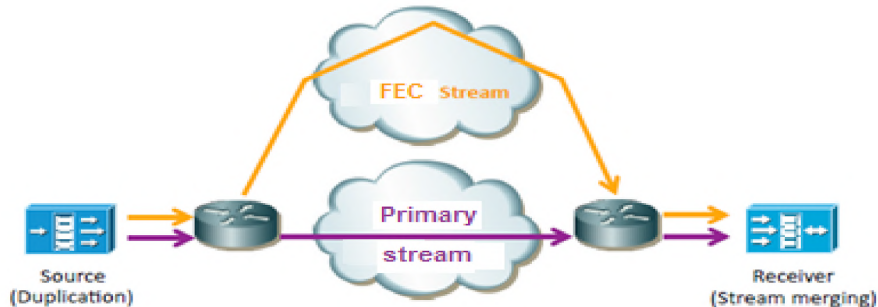

Time diversity

IQOYA doesn't only propose passive duplication as on most codecs. It also allows delaying the duplicate stream compared to the primary stream. Although the primary stream and the FEC stream are configured to use different networks, it is quite common that some network components are common to both networks (last mile router for instance). The selected delay avoids that temporary failures occurring on common network components impact both a primary frame and its duplicate frame.

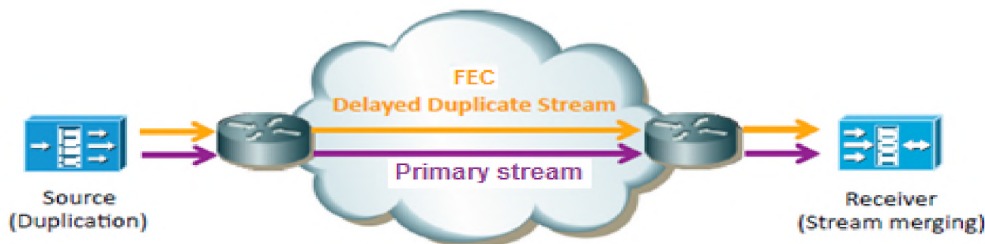

Multicast and unicast can be used for redundant dual streaming, and different UDP ports can also be used for the primary stream and the FEC stream.

A typical redundant dual streaming configuration is as follows:

- Enter the destination IP address and UDP port of the primary stream. The IP address can be the public IP address of the Eth interface of the IQOYA that decodes the stream, or a multicast address. Select the IP interface used to send the stream in case of multicast.
- Select a “Dual stream” FEC, with or without time delay. Enter if necessary the destination IP address and UDP port of the FEC stream. The IP address can be the public IP address of another Eth interface of the

IQOYA that decodes the stream, or a multicast address. Select the IP interface used to send the FEC stream.

Notes:

- When in-band audio format signaling is enabled, FEC stream is sent to the same IP address as the primary stream, and on UDP port + 2.
- When in-band audio format signaling is disabled, it is possible to define the destination address and port of the FEC stream.