



RemoteAmp™
Stereo Headphone Amplifier
User Guide

JK Audio

Welcome

Thank You

Thank you for purchasing the JK Audio RemoteAmp. Please read this guide for instructions on setting up and using your new product.

Getting Assistance

If you have any questions, call us **M-F: 8:30am-5:00pm (CT)**

In the US & Canada (Toll-Free)

800-552-8346

All other countries dial:

815-786-2929

Email us at:

support@jkaudio.com

Or, check out our FAQ section for answers to common questions.

Limited Warranty

RemoteAmp is covered by a 1 year warranty to be free from defective workmanship and materials. To obtain service, contact JK Audio by phone or email for return authorization.

Once authorized, you will carefully pack and ship the faulty product and all accessories to us. You will pay for shipping to us and we will pay for return back to you.

This warranty does not cover damages due to accident, weather, fire, flood, earthquake, misuse, unauthorized repairs or modifications, or damages occurred in shipping, only defective workmanship or materials.

There are no expressed or implied warranties which extend beyond the warranty here made.

Safety Precautions



Caution: To prevent possible hearing damage, avoid listening at high volume levels for long periods.

RemoteAmp contains a headphone amplifier that is more powerful than the typical consumer product.

JK Audio products are designed for the broadcast industry. The broadcast professional must be able to hear headphone signals over the ambient noise level. From the cheering crowd at a football game to trackside at a car race, the program material or cues must be heard at high volumes without distortion.



Road Safety

Never use headphones while driving or cycling, etc. It can be dangerous to turn up the volume even while walking. Doing so may hinder your hearing and can be hazardous on the roadways or at pedestrian crossings.



Handle with Care

While RemoteAmp was designed to be very rugged and durable, it is not waterproof and care should be taken to keep the unit dry.

Welcome

Overview	1
Setup	2
Operation	4
FAQs	5
Technical Information	7

Introducing RemoteAmp

The RemoteAmp is a simple battery-powered personal headphone amplifier. Use the RemoteAmp as an IFB earpiece or headphone amplifier, or as an on-stage monitor headphone amplifier. This low-distortion, ½ watt amplifier will cut through the crowd noise without distortion.

Features

Compatible with TW (Two-Wire)
Party-Line Intercoms (Listen-Only)

XLR Line level Input Jack

1/8" (3.5mm) Stereo Line Input Jack

Master Level Control

1/4" Stereo Headphone Jack

1/8" (3.5mm) Stereo Headphone Jack

Battery Test Indicator

Stainless Steel Belt Clip

>20 Hours on one 9V Battery

Setup



1. Level Control

Controls the level of audio from both the mono XLR and stereo 1/8" (3.5mm) inputs.

2. 1/8" Stereo Headphone Jack

The 1/8" (3.5mm) Stereo Headphone Jack provides a mix of the XLR Line input and the 1/8" (3.5mm) Stereo Line Input.

3. 1/4" Stereo Headphone Jack

The 1/4" Stereo Headphone Jack provides a mix of the XLR Line input and the 1/8" (3.5mm) Stereo Line Input.

4. Power Switch

Flip this switch Up to activate the unit. Flip this switch Down to turn the unit off.

5. 1/8" Stereo Line Input

Connect the headphone output of any device to this low impedance unbalanced stereo 1/8" (3.5mm) Line Input jack.

6. XLR Line Input

The input XLR accepts line level signals from your mixer, distribution amplifier or phone line hybrid.

The balanced input XLR is wired:

Pin 1	Pin 2	Pin 3
Ground	Signal +	Signal -

This is a transformer balanced input. If you are using an unbalanced source, you must connect your signal lead to Pin 2 and then connect your ground to Pins 1 and 3.

Operation

Gain Adjustment

Behind the back cover of the RemoteAmp you will find two jumpers on the circuit board — J7 for the Left channel and J8 for the Right channel. These jumpers allow you to adjust the maximum amount of gain the RemoteAmp delivers. In the factory default open position you will receive a maximum of 25 dB gain. If the jumpers are set to the optional closed position, a maximum of 40 dB gain will be delivered.

Battery

An alkaline battery is strongly recommended. The battery test indicator shows the strength of the battery power remaining. A bright light indicates plenty of power, a dim light reminds you to be prepared with a fresh battery. Once the LED stops responding to the test switch, you will begin to hear signal breakup and distortion as the battery is drained of its last breath which may mean minutes or hours depending on the circumstances.

Will the RemoteAmp work with my QuickTap IFB?

Yes. The RemoteAmp will take the balanced output from the QuickTap IFB and send it to a 1/4" Stereo Headphone Jack as well as a 1/8" (3.5mm) Stereo Headphone Jack. You can now use headphones, an earpiece or both.

Can I get more gain out of my RemoteAmp?

Yes. Take the back off of the RemoteAmp and install both jumpers (J7,J8). This will give you enough gain to boost a healthy microphone level signal to headphone level output.

Block Diagram

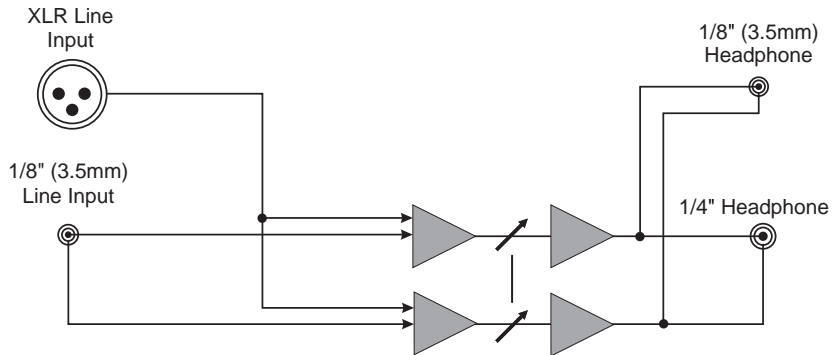

Specifications

Line Input

Female XLR:	4k ohms / 100 mV RMS (-18 dBu nom, +4 dBu max) Max Gain: 46 dB
-------------	--

1/8" (3.5mm) Line In:	50 ohms, -10 dBu nom, +12 dBu max
-----------------------	-----------------------------------

Headphones

1/4" Stereo Headphone:	8 ohms, 500 mW per channel
------------------------	----------------------------

1/8" (3.5mm) Stereo Headphone:	10 ohms, 430 mW per channel
-----------------------------------	-----------------------------

Misc.

Stereo Separation:	46 dB
--------------------	-------

Frequency Response:	50 Hz - 20 kHz \pm 1 dB
---------------------	---------------------------

Power:	One 9 volt Alkaline Battery
--------	-----------------------------

Size:	5.1" x 2.7" x 1.3" (13 x 6.9 x 3.3 cm)
-------	--

Weight:	10 oz. (275 g)
---------	----------------

RemoteAmp™

Stereo Headphone Amplifier



User Guide Version 4/16/22

JK Audio, Inc.

1311 E 6th St.

Sandwich, IL 60548

United States

Telephone: 815.786.2929

Toll Free: 1.800.jkaudio

Fax: 815.786.8502

www.jkaudio.com

© 2022 JK Audio, Inc. All rights reserved.

JK Audio