



RemoteMix 4™ Broadcast Field Mixer



User Guide

Welcome

Thank You

Thank you for purchasing a JK Audio RemoteMix 4 Broadcast Field Mixer. Please read this guide for instructions on setting up and using your new product.

Getting Assistance

If you have technical or application questions, call us **M-F: 8:30am-5:00pm (CT)**

In the US & Canada (Toll-Free)
800-552-8346

All other countries:
815-786-2929

Email us at:
support@jkaudio.com

Or check out our **FAQ** section for answers to common questions.

Warnings & Safety Precautions

- Read and keep these instructions.
- Follow all instructions.
- Clean only with a soft dry cloth.
- Refer all servicing to qualified service personnel.
- Heed all warnings



Caution: To prevent possible hearing damage, avoid listening at high volume levels for long periods.

RemoteMix 4 contains a headphone amplifier that is more powerful than the typical consumer product.

JK Audio products are designed for the broadcast industry. The broadcast professional must be able to hear headphone signals over the ambient noise level. From the cheering crowd at a football game to trackside at a car race, the program material or cues must be heard at high volumes without distortion.



Road Safety

Never use headphones while driving or cycling, etc. It can be dangerous to turn up the volume even while walking. Doing so may hinder your hearing and can be hazardous on the roadways or at pedestrian crossings.



Handle with Care

While RemoteMix 4 was designed to be very rugged and durable, it is not waterproof and care should be taken to keep the unit dry.

Overview	1
Getting to know your RemoteMix 4™ 2 Controls & Indicators 4 Inputs & Outputs	2
Getting Connected Setting Up Making a Call	6
Operation	7
Bluetooth Wireless Technology 8 Status LED, Pairing 9 Reconnecting, and Disconnecting	8
FAQs	10
Technical Information	12

Limited Warranty

The RemoteMix 4 is covered by a 1 year warranty to be free from defective workmanship and materials. To obtain service, contact JK Audio by phone or email for return authorization. Once authorized, you will carefully pack and ship the faulty product and all accessories to us. You will pay for shipping to us and we will pay for return back to you.

This warranty does not cover damages due to accident, weather, fire, flood, earthquake, misuse, unauthorized repairs or modifications, or damages occurred in shipping, only defective workmanship or materials.

There are no expressed or implied warranties which extend beyond the warranty here made.

Features

HD Voice Compatible
(7 kHz Wide-Band Speech)

Works with Analog and Digital PBX
or VoIP Phones

Connects to Wireless Phones
& Notebooks

Bluetooth Wireless Technology

4-conductor 3.5mm Headset Interface

Four XLR Mic Jacks

Mic/Line Pad Switch

Individually Switchable 48v Phantom
Power

¼" Headphone Jacks with Individual
Level Controls

Individual Headphone Source
Selector

3.5 mm Send and Receive Jacks

LED VU Meter

Phone Line Hybrid with DTMF
Keypad

Redial Button

Handset Selector Switch (Electret,
Carbon, Dynamic)

Bass Boost

Hot Swappable Dual 9V Batteries and
120-240 VAC External Power Supply

In the Box

Universal Power supply with
detachable cord

3.5 mm 4-conductor Wireless
Interface Cable

18" RJ22 Modular Handset Cord

60" RJ11 Phone Cord

HD Voice

While standard phone calls have a narrow bandwidth of 300 Hz to 3.4 kHz, HD Voice calls offer 50 Hz to 7 kHz bandwidth. The additional 1.5 octaves on the low end gives voice a more natural sound, while the additional upper octave dramatically improves speech clarity and intelligibility.

Wireless HD Calls

HD Voice is available on many third party headsets and cell phones. To take advantage of this extended bandwidth, both phones on the call must support HD Voice, and both phones must be on the same carrier, in coverage areas that support HD Voice.

Introducing the RemoteMix 4™

JK Audio introduces RemoteMix 4, a three-channel field mixer and headphone amplifier. More than just a field mixer, this is a universal communications interface. RemoteMix 4 features a phone line hybrid and keypad, a PBX handset interface, and both wired and wireless cell phone interfaces. These parts were designed to work together, saving setup time in the field.

Radio – RemoteMix 4™ is perfect for sports remotes. Use it as a phone line hybrid, calling into your studio talk show hybrid. Use it as a front-end mixer for your POTS, ISDN, IP or smart phone codec.

TV – RemoteMix 4™ gives you the ultimate phone connectivity with four ¼" IFB headphone feeds. Send and receive interview audio and pull IFB out of any business phone system, even your cell phone or notebook.

Great Sound – A soft limiter prevents overdriving the phone line interfaces, while the mixer XLR output is pre-limiter (full range). Convenient 3.5mm send and receive jacks for recording the show, or mixing in your MP3 player.

Bluetooth Wireless Technology – Route audio through your cell phone or notebook using Bluetooth Wireless Technology. RemoteMix 4 will connect in Hands-Free mode allowing a two-way 3.4 kHz telecom bandwidth connection. RemoteMix 4 can also connect in A2DP mode offering a 20 kHz audio bandwidth, listen-only connection.

Wireless Phones and Notebooks – Simply plug RemoteMix 4 into the 3.5 mm headset jack of your wireless phone or notebook computer. Your cell phone will recognize RemoteMix 4 as a headset which will disable the internal mic and speaker.

ISDN, PBX, and VoIP Systems – Unplug the handset from any phone and plug the coily cord into RemoteMix 4. You can now send and receive audio through the ISDN, PBX, or VoIP telephone set.

Monitoring – Convenient 3.5 mm send and receive jacks for recording the show, or mixing in your MP3 player. Separate headphone level and source selection controls. Monitor just the clean mixer output, or the communication return plus the mix.

Power Smart Design – Phantom power is not always needed, yet it can be a real drain on batteries. The phantom power generator only runs if any of the rear panel 48 V switches are set to "ON" position. Low noise, low power ICs are used throughout to preserve battery life. The 100-240 VAC desktop style power supply (included) overrides the battery power only when the supply is actually providing power. If the power goes out, the batteries automatically cut in. Use one battery or two. Separate compartments for hot swapping batteries.

Getting to Know Your RemoteMix 4



Controls & Indicators

1. Mic Level Controls

Each of the four XLR inputs has a level control knob with a separate red **<Peak>** LED to indicate clipping on each channel. If you see more than an occasional flash of the **<Peak>** LED you should decrease the level for that channel.

2. Master Level Control

The **<Master>** control knob will set the overall level of the sum of all the mic and line inputs. The LED meter for the master audio level ranges from -30 dB to +3 dB.

3. Keypad

The telephone keypad provides DTMF tone dialing. You may use the keypad at anytime during a call but keep in mind that both transmit and receive telephone audio are muted during a keypress.

4. Redial

Press this button to instantly redial the last telephone number that was keyed in.

5. Headphone Controls

Each of the four headphone outputs has a separate level control so each listener can adjust their audio level independently.

Controls & Indicators Cont'd

6 Cue Control

The <Cue> input control adjusts the signal going to the headphones from the 1/4" <Cue Input>. When using the 1/4" Cue Input Wireless Interface, the individual headphone level control adjusts the overall level of your headphones while the <Cue> input control adjusts the level of the person on the other side of the call in all headphones. You should keep in mind that your wireless telephone also has level control. If you are having level problems that cannot be corrected with the controls on the RemoteMix 4, try adjusting the level on the wireless telephone itself.

7 Bluetooth Wireless Technology

This switch activates the Bluetooth Wireless Technology. The blue LED directly above this switch indicates when it is on.

8 Keypad Switch

This switch disables the DTMF keypad to prevent unwanted tones from being transmitted down the phone line during a broadcast.

9 Ringer

RemoteMix 4 does not have an audible ringer but there is a visual ring indicator that will flash for incoming calls. This red LED is located directly below the keypad.

10 Phone Line Switch

When using the RJ-11 analog phone jack, this switch acts as the switch-hook for the telephone line. The *On Hook* position is when you are not using the line or you are waiting for a call. When you want to place a call, or when a call comes in, switch to the *Dial/Talk* position.

11 Power

This is the main power switch that turns the unit on. Whenever the power is turned on, the red LED above this switch will be lit. The green <AC> LED will be lit whenever a live AC power source is connected, even if the main power switch is off.

Getting to Know Your RemoteMix 4

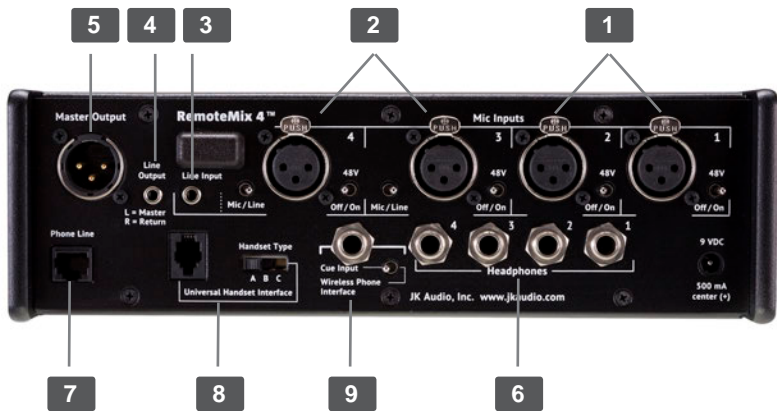

Inputs & Outputs

- 1. Mic Inputs 1 and 2**
Balanced XLR jacks with low-noise pre-amplifiers.
- 2. Mic Inputs 3 and 4**
Balanced XLR jacks with low-noise pre-amplifiers. A **<Mic/Line>** selector switch adds a 40 dB pad for a line level balanced input.
- 3. Stereo 3.5 mm Line Level Input**
The stereo 3.5 mm line level input can be used instead of or in addition to the channel 4 XLR input. You can connect either a mono or stereo signal to this mini jack. If you use a stereo input, both channels will immediately be summed together. Then the audio from the mini jack and the XLR would be added together and treated as one mono signal on channel 4
- 4. Stereo 3.5mm Line Level Output**
Can be connected to your mini disk or other recording device. The **<Master Output>** will be on the Left channel and the Receive mix from the phone line and/or **< Cue input >** on the Right channel.
- 5. The Master Output**
A balanced XLR jack that contains the sum of all four input XLRs and the 3.5 mm input. This audio signal has a full 20 Hz to 20 kHz bandwidth.
- 6. Headphone Jacks**
Headphone output is a mix of local mic and line inputs including the return from the phone line.

Phone Line Connection

7. Phone Line

The RemoteMix 4 has an RJ-11 jack that can be connected to any standard, single line analog telephone line. This jack should not be connected directly to digital PBX or ISDN phone systems.

8. Handset Interface

If you do not have access to an analog phone line or if the phone system is a digital or analog PBX, ISDN, VOIP or a key telephone system, you can use the built-in handset interface. Disconnect the telephone handset from the coily cord and plug the cord into the RemoteMix 4 **<Universal Handset Interface>** jack. Now select the handset type on the 3 position switch.

Trial and error works faster than a chart of handset types, but this basic description may help.

Switch Position	Handset Microphone Type
A	Electret
B	Dynamic
C	Carbon

9. Cue Input / Wireless Phone Interface

RemoteMix 4 comes equipped with a **<Wireless Phone Interface>** built in to the 1/4" **<Cue Input>**. This 1/4" wireless interface accepts a specially designed 1/4" to 3.5mm cable provided with the unit. This interface works with any wireless phone or notebook that accepts standard third party headsets and earpieces. Your product has been supplied with a 1/4" TRS to 3.5mm TRRS interface cable. While the majority of current wireless phones use a 4 conductor, 3.5mm TRRS headset jack, some older phones use a 2.5mm TRS headset jack. If your phone uses this smaller 2.5mm headset jack, you may contact our support department to request a compatible interface cable.

When using the wireless interface, it is important to keep your wireless telephone 12" - 24" away from the RemoteMix 4 and any microphone or headphone cables. This will help prevent unwanted RF noise from entering the unit.

Getting Connected

Setting Up

1. Connect your audio equipment, microphones, cue input, and headphones to the input and output jacks on RemoteMix 4.
2. There are 4 ways to connect the RemoteMix 4 to the phone line:

- A. **For Analog Phones:** Connect the jack marked **<Phone Line>** to any standard analog telephone line, **or**
- B. **If there is no access to an Analog Phone Line:** Disconnect the handset on an existing telephone and plug the coily cord from the phone into the **<Universal Handset Interface>** jack on RemoteMix 4, **or**
- C. **If there is no Land Line:** Connect the **<Wireless Phone Interface>** jack to the headset jack on your cellular telephone using the supplied JK Audio interface cable.

The 1/4" Wireless Interface jack also serves as a **<Cue Input>** that feeds the headphones. Connect any line level output here, such as the output from your personal audio player. This signal does not reach the XLR output but will be present on the right channel (return) of the stereo output.

- D. **Bluetooth Wireless Technology.** See page 8.

Making a Call

There are also 3 ways to initiate an outbound call with the RemoteMix 4. First turn on the power switch and flip the **<Phone Line>** switch to *Dial/Talk*.

- A. **When connected to an analog line:** Flip the **<Keypad>** switch to *On* and dial your call. You are now ready to broadcast or record a telephone interview.
- B. **When connected via the Universal Handset Interface on the RemoteMix 4:** Take the handset off of the cradle of the phone you are connected to and dial with the keypad on the base of that phone. The handset must stay off-hook for the duration of the broadcast or the call will be disconnected.
- C. **When connected via the 1/4" Cue Input / Wireless Phone Interface:** Dial the call with your cellular phone handset. Audio will automatically be transmitted and received through the RemoteMix 4 audio inputs and outputs. The phone's internal speaker and microphone will be disabled during the call. Feel free to leave your phone connected to power throughout the broadcast to conserve battery power.

IFB

If using the phone line or handset interface for an IFB feed, the balanced male XLR output may be used to feed an IFB earpiece or other device. If using the 1/4" cue input / wireless adapter jack for the telephone connection, the IFB feed must be taken from one of the 1/4" headphone jacks. This also applies if you are planning to record both sides of the conversation while using the 1/4" wireless adapter jack for the telephone connection.

Power

RemoteMix 4 is powered by two 9 volt alkaline batteries located on the side of the unit. The red **<Power>** LED on the front of the device will gradually dim as the battery runs down, then extinguish about a half hour before the unit shuts down. Since these two batteries are in separate drawers and wired in parallel, you can hot swap one battery at a time so you never lose power.



It is important to replace both at the same time with identical batteries. If two fresh batteries are not available, it is better to run using only one good battery. Since the battery fixtures are wired in parallel, it does not matter which one gets the single battery.

We also provide a high quality, regulated AC to DC adapter to power RemoteMix 4 when AC power is available. Simply plug it into the back of RemoteMix 4 and plug the transformer into a wall outlet. This is a switching power supply so you can connect to a 110 or 220 VAC power source. When the power connector is inserted into the jack, the batteries are bypassed. The AC adapter does not charge the batteries. If you lose power during your broadcast, the RemoteMix 4 automatically reverts to battery power so your broadcast will not be interrupted.

Make sure you use only the supplied AC power adapter with the RemoteMix 4. Using any other adapter could damage the unit.

WARNING! It is strongly recommended that this product be connected to an adequate surge protection device for the power line as well as the telephone line at all times.

Bluetooth Wireless Technology

When attempting to put the unit into Idle or Pairing mode, you should power the unit off then back on before pressing the <  > switch. If you put the unit into the wrong state due to releasing the <  > switch at the wrong time, holding the <  > switch for “X” seconds will not put it into the desired mode.

Pairing Mode

Pull up the <  > switch for **5** seconds while the unit is on.

In *Pairing Mode*, any Bluetooth enabled device within range can pair with your RemoteMix 4. When you're first connecting to a new device, you should be in an environment with no other Bluetooth wireless technology enabled devices within range that might also be in Pairing Mode.

Once the pairing process is complete the unique device ID is stored in Connection History. Subsequent connections can be made automatically from *Idle Mode*.

Idle Mode

Pull up the <  > switch for **2** sec when the unit is on. In *Idle Mode*, RemoteMix 4 searches for paired devices.

Connected Mode

After bonding is complete, the connection to that device is secure. RemoteMix 4 returns to *Idle Mode* when a connection is dropped or terminated.

Bluetooth Status LED

The blue LED on the front of the unit flashes in different sequences to indicate the current connection status.

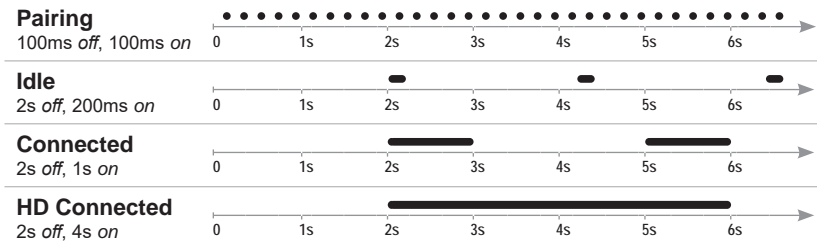

Pairing to a Device with Bluetooth Wireless Technology

1. Set your Bluetooth device to Pairing Mode following the manufacturer's instructions.
2. On the RemoteMix 4, pull up on the switch and hold for approximately 5 seconds. The blue LED will begin to flash rapidly as RemoteMix 4 enters **Pairing Mode**. *Pairing Mode* will time out in 2 minutes.
3. On your Bluetooth device, from the list of Bluetooth connections, select "**JKRM4xxxx**" where "**xxxx**" corresponds to the last 4 digits of the unit's serial number. Enter "**Yes**" when asked to bond with this device. The pin is "**0000**".
4. When bonding is completed, the blue LED will flash at a rate of 2 secs *off*, 1 sec *on*.

Reconnecting to a Device with Bluetooth Wireless Technology

Once RemoteMix 4 has been added to your Bluetooth device, subsequent connections can be made more quickly from *Idle Mode*. Simply hold the switch up >2 seconds to reach *Idle Mode* for faster connection. *Idle Mode* will time out in 2 minutes if the device is left unused or call is disconnected.

Disconnecting from a Device with Bluetooth Wireless Technology

To disconnect from the Bluetooth device, simply pull up on the switch and hold for 5 seconds.

Bluetooth Wireless Technology

RemoteMix 4 will first attempt to connect in Hands-Free mode offering a 3.4 kHz mono duplex connection. If both phones on the call support HD voice, Hands-Free mode supports a 7 kHz mono duplex connection. If a Hands-Free connection is not available, RemoteMix 4 will attempt to connect in A2DP mode with a 20 kHz, one-way, stereo connection. Consult your cell phone or portable device for more details.

FAQs

1) Why do I keep getting an error message when I try to pair with my Bluetooth enabled cell phone?

There is a difference between *Idle Mode* and *Pairing Mode*. The first time you make a connection with a new Bluetooth enabled device, you must be in *Pairing Mode*. Please read carefully through the instructions on page 8 of this User Guide for detailed information.

2) What is the range of the Bluetooth transmitter/receiver?

The RemoteMix 4 will transmit and receive audio signals up to 33 feet from your Bluetooth device. The maximum range of this product is achieved when a clear line of sight is maintained between connected devices, but may also be limited by interference due to the environment. While this product offers extended range capabilities, maximum usable range is limited by the weaker of the two paired/connected devices. Transmitting signals over longer distances will require more power, therefore you should keep RemoteMix 4 as close as possible to your Bluetooth device to conserve battery power.

3) How long will the batteries last in my RemoteMix 4?

There are many variables that affect battery life, such as the number of headphones, and the use of Bluetooth. All of our battery life tests included 3 headphones playing music at average listening levels. These tests use standard alkaline batteries. Lithium batteries can add 3 to 4 times the battery life, at 3 to 4 times the cost.

The following numbers are from lab tests and may not represent your usage:

7 hours of broadcast through a cell phone using Bluetooth Wireless Technology at a distance of 1 meter.

10 hours of broadcast through the phone line hybrid, using dynamic microphones.

4) Why doesn't my RemoteMix 4 ring when a call comes in?

The audible ringer found on some of our other RemoteMix units was replaced with a visual ring indicator on the RemoteMix 4. This red LED flashes when a call comes in. The Ring indicator is located directly below the keypad on the front of the unit.

5) Will any cellular telephone work with RemoteMix 4?

The wireless interface on the RemoteMix 4 works very well with most cellular telephones. However, some wireless telephones generate excessive RF noise which can be heard as a "chattering" or "motor boat" sound. The noise from these particular telephones will be unacceptable for most broadcast applications.

RemoteMix 4 is supplied with a 1/4" TRS to 3.5mm TRRS interface cable. While the majority of current wireless phones use a 4 conductor, 3.5mm TRRS headset jack, some older phones use a 2.5mm TRS headset jack. If your phone uses this smaller 2.5mm headset jack, you may contact our support department to request a compatible interface cable.

6) What kind of device can I connect to the Cue Input?

Setting the switch for the dual-purpose 1/4" input to *Cue Input* will provide a standard line level input for connection to another audio device, such as a portable radio. The audio signal will be sent to all three of the headphone outputs. This way, your announcers can listen for a cue from their radio station at the end of a station break.

7) The cellular interface cable was left behind at our last event. Can I get a replacement at our local audio supply store?

This is a custom made cable and is not wired the same as those that may be available at your local electronics store. Please contact your JK Audio dealer or our Customer Service department and ask for a CN113 replacement cable. The CN113 has a 3.5 mm TRRS headset plug. Most newer phones, especially those that include a mp3 player, have a 3.5mm TRRS headset jack and therefore require the CN113 cable.

8) The output from Mic 4 is very low but the other mics are fine.

Check the position of the <Mic/Line> switch near <Mic 4>. This input can be switched to accept a line level signal from a mixer or other equipment.

9) How can I tell how much battery life is remaining?

The red <Power> LED functions as a battery life gauge that will gradually dim as the battery runs down. This red LED will go completely dark about a half hour before the unit shuts down. Keep in mind that the VU meter, Bluetooth, and clipping LEDs will remain bright until the unit stops functioning.

10) Does the AC power supply charge the batteries?

No. You may use rechargeable batteries, but you must remove and recharge the batteries outside of the RemoteMix 4.

11) I have lost my power supply for my RemoteMix 4 unit. I have a power supply that fits from a different product. Can I use this instead?

No! Never use a power supply other than the one that was supplied by your manufacturer. Power supplies are available in either AC or DC output with many combinations of voltage and available current. Most consumer power supplies are not regulated. This could invariably damage your equipment, and also create a great deal of noise. Our products are designed for and tested with their respective power supplies for optimum operation. If you have lost your power supply, please contact your JK Audio dealer or our Customer Service department and ask for a PS009 power supply for your RemoteMix 4.

Technical Information

Block Diagram

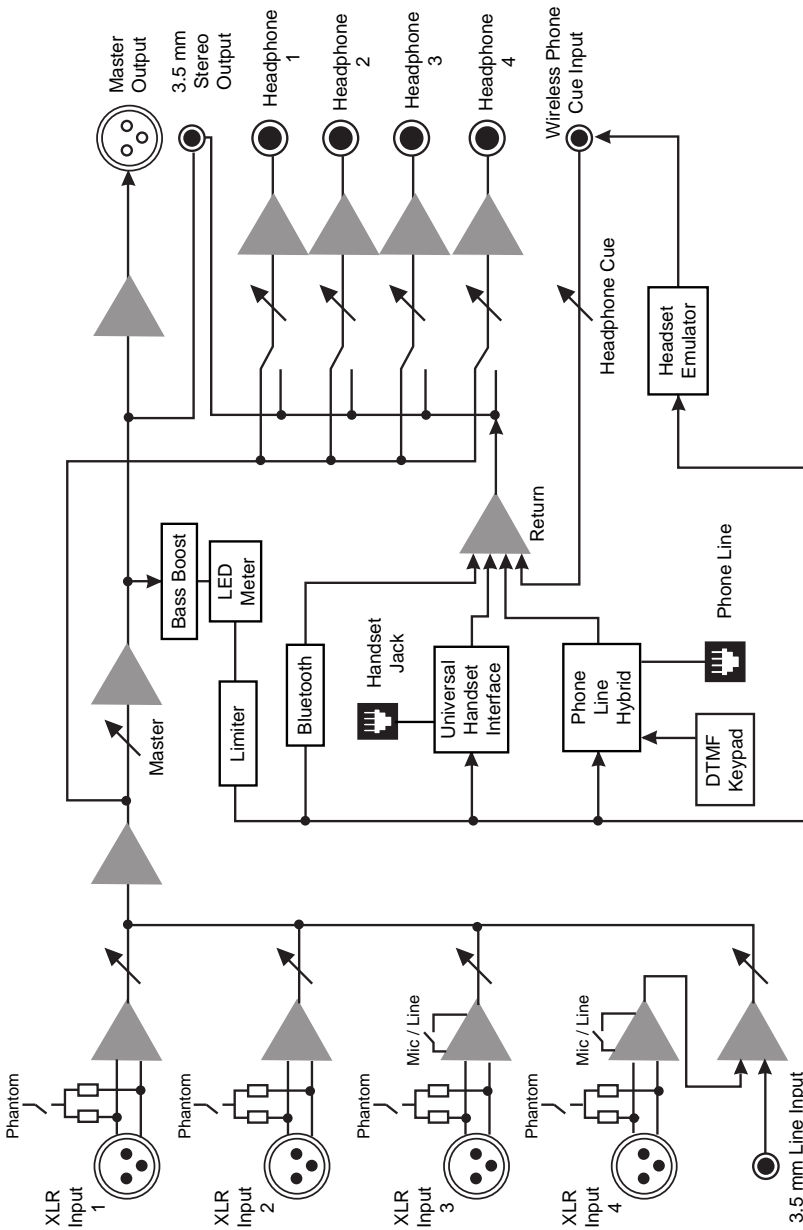

Specifications

Input	Impedance / Level
Female XLR (4) Mics:	2k ohms / -25 dBu nom (Channel 3 & 4: Mic/Line pad switch = +6 dBu max)
1/8" (3.5mm) Stereo Line:	20k ohms / -10 dBm nom
Headphone Cue 1/4":	20k ohms / -10 dBu nom

Output

Balanced Male XLR:	+16 dBu max, 20 Hz - 20 kHz, +/- 1dB
1/8" (3.5mm) Stereo:	100 ohms, -10 dBu nom
Headphone 1/4" Stereo:	8 ohms / 1/3 watt per channel

Bluetooth Wireless Technology

Standard:	Bluetooth 3.0
Frequency Response:	Hands-Free (phone): 300 Hz - 3.4 kHz Hands-Free (HD Voice): 50 Hz -7 kHz A2DP Mode: 30Hz - 17 kHz
Range:	33 ft (10 meters)

Misc.

Phone Line Connector	RJ11C
PBX Interface	RJ22
Ringer	0.5B REN
Isolation	1500 VAC
Power	100-240 VAC, 50-60Hz or Two 9 VDC batteries
Size	9.5" x 8" x 3"
Weight	3.8 lbs

Declaration of Conformity

Manufacturer's Name:	JK Audio, Inc.
Manufacturer's Address:	1311 E 6 th Street Sandwich, Illinois 60548 USA

Declares that the product:

Product Name:	RemoteMix 4 Broadcast Field Mixer
Model Numbers:	RemoteMix 4

Conforms to the following Product Specifications:

Safety:	AS/NZS 60950.1:2003 CAN/CSA-C22.2 No. 60950-01-03 UL Standard 60950-01 1st edition
ESD:	EN 55024:1998; EN 61000-3-2; EN 61000-3-3

FCC Registration

Declaration of Conformity Cont'd

Emissions:	EN 55022:1998 AS/NZS CISPR 22 (2002) FCC Part 15, Subpart B ICES-003 EN 300 328 FCC Part 15.247 FCC ID R47F2M03MLA IC Radio Standards RSS-210 Annex 8
Telecom:	AS/ACIF S002:2005 FCC CFR 47, Part 68 TIA968 A-1, A-2, A-3, A-4

The product herewith complies with the requirements of the following Directives and carries the CE marking accordingly:

LVD 2006/95/EC (Safety)
R&TTE 1999/5/EC (Telecom)
EMC 89/336/EEC (EMC)
RoHS Directive 2015/863

The Technical File containing supporting documentation is maintained at:

JK Audio, Inc (Corporate Headquarters)
Compliance Manager
1311 E 6th Street
Sandwich, Illinois 60548 USA
815-786-2929 phone
815-786-8502 fax

FCC Registration

Your new JK Audio product has been registered with the Federal Communications Commission (FCC). This product complies with the standards in Part 68 of the FCC rules.

1. Connection and use with the nationwide telephone network

The FCC requires that you connect this telephone equipment to the national telephone network through a USOC RJ-11C modular telephone jack. This equipment may not be used with Party Line Service or Coin Telephone Lines. This equipment is hearing aid compatible.

2. Information for the telephone company

Upon request from your local telephone company, you are required to provide the following information:

- A. The "line" to which you will connect the telephone equipment (that is, your telephone number), and
- B. The telephone equipment's FCC registration number. This can be found on the bottom of your telephone equipment, and,
- C. The ringer equivalence number (REN) for this equipment. The REN is used to determine the quantity of devices which will be connected to the telephone line. Excessive RENs on the telephone line may result in the devices not ringing in response to an incoming call. In most, but not all areas, the sum of the RENs should not exceed 5.0. To be certain of the number of devices that may be connected to the line, as determined by the total RENs, contact the local telephone company.

3. Repair Instructions

If it is determined that your telephone equipment is malfunctioning, the FCC requires that it not be used and that it be unplugged from the modular outlet until the problem has been corrected. Repairs to this telephone equipment can only be made by the manufacturer or its authorized agents or by others who may be authorized by the FCC. For repair procedures, follow the instructions outlined under the warranty section of the manual.

4. Rights of the telephone company

If telephone equipment is causing harm to the network, the telephone company may temporarily discontinue your telephone service. If possible, they'll notify you before they interrupt service. If advanced notice isn't practical, you'll be notified as soon as possible. You'll be given the opportunity to correct the problem, and you'll be informed of your right to file a complaint with the FCC. Your telephone company may make changes in its facilities, equipment, operations or procedures that could affect the proper functioning of your JK Audio product. If such changes are planned, you'll be notified by your telephone company.

FCC Part 15 Subpart A Compliance

This equipment has been tested and found to comply with the limits for a Class A digital device, pursuant to Part 15 of the FCC Rules. These limits are designed to provide reasonable protection against harmful interference when the equipment is operated in a commercial environment. This equipment generates, uses, and can radiate radio frequency energy and, if not installed and used in accordance with the instruction manual, may cause harmful interference to radio communications. Operation of this equipment in a residential area is likely to cause harmful interference in which case the user will be required to correct the interference at his/her own expense.

Changes or modifications not expressly approved by JK Audio can void the user's authority to operate the equipment.

FCC Part 15 Subpart B Compliance

This device has been tested and found to comply with the limits for a Class B digital device, pursuant to Part 15 of the FCC rules. These limits are designed to provide reasonable protection against harmful interference when the equipment is operated in a commercial environment. This equipment generates, uses and can radiate radio frequency energy and, if not installed and used in accordance with the instruction manual, may cause harmful interference to radio communication. Operation of this equipment in a residential area is likely to cause harmful interference, in which case the user will be required to correct the interference at his/her own expense.

Changes or modifications not expressly approved by JK Audio can void the user's authority to operate the equipment.

Shielded interface cables and AC power cord, if any, must be used in order to comply with the emission limits.

The internal antennas used for this mobile transmitter must not be colocated or operated in conjunction with any other antenna or transmitter.

RemoteMix 4™
Broadcast Field Mixer



User Guide Version 7/5/22

JK Audio, Inc.
1311 E 6th St.
Sandwich, IL 60548
United States
Telephone: 815.786.2929
Toll Free: 1.800.jkaudio
Fax: 815.786.8502
www.jkaudio.com

© 2022 JK Audio, Inc. All rights reserved.

JK Audio