



Voice Path™
Telephone Handset Audio Tap
User Guide

JK Audio

Welcome

Thank You

Thank you for purchasing the JK Audio Voice Path. Please read this guide for instructions on setting up and using your new product.

Getting Assistance

If you have any questions, call us **M-F: 8:30am-5:00pm (CT)**

In the US & Canada (Toll-Free)

800-552-8346

All other countries dial:

815-786-2929

Email us at:

support@jkaudio.com

Or, check out our FAQ section for answers to common questions.

Limited Warranty

Voice Path is covered by a 2 year warranty to be free from defective workmanship and materials. To obtain service, contact JK Audio by phone or email for return authorization.

Once authorized, you will carefully pack and ship the faulty product and all accessories to us. You will pay for shipping to us and we will pay for return back to you.

This warranty does not cover damages due to accident, weather, fire, flood, earthquake, misuse, unauthorized repairs or modifications, or damages occurred in shipping, only defective workmanship or materials.

There are no expressed or implied warranties which extend beyond the warranty here made.

Contents

Overview	1
Setup	3
Operation	4
FAQs	6
Technical Information	8

Note: While Voice Path was designed to be very rugged and durable, it is not waterproof and care should be taken to keep the unit dry.

Features

Works with Analog, Digital, PBX, and VoIP Telephones

1/8" (3.5mm) Mono Audio Input

1/8" (3.5mm) Mono Audio Output

Output Level Control

Switch Selects Between Carbon, Dynamic or Electret Handset Types

Passive Design. No Battery or AC Required

In the Box

18" Flat Handset Jumper Cable

Introducing Voice Path

Voice Path continuously routes both sides of your conversation to the mic input of your PC (or Mac) sound card. Simply press in the gray button when you are ready to play audio recordings back into the phone line. With the button in, Voice Path will disconnect the microphone from your handset and send audio down the phone line and into your receiver. You will hear the transmit audio as well as the voice from the other end of the call.

Input to Phone

The cable marked **<To Phone>** accepts a line level signal from your computer sound card to send down the telephone line. This can be audio streaming from the internet, CD audio,

a conversation previously recorded from the Voice Path, or any other audio that would normally play through your computer speakers.

Output to PC

The cable marked **<From Phone>** sends a mic level signal to your computer sound card's mic input. This signal will contain a mix of your voice (or other audio sent down the phone line) and the audio from the other end of the call. This mix ratio is not adjustable, it is a function of the telephone, not our product. As it turns out, this is a suitable mix ratio for most applications.

Overview



Getting Connected

Voice Path connects between the handset and the base of your telephone. Follow these simple steps:

1. Unplug the modular handset cord from your telephone base.
2. Using the black handset jumper cord that we have provided, connect the **<Phone>** jack of Voice Path to the handset jack on the base of your telephone.
3. Plug your handset cord, and handset (or headset), into the **<Handset>** jack on Voice Path.
4. Connect the **<From Phone>** cable to the mic input on your computer.
5. Connect the **<To Phone>** cable to the line output on your computer.

Note: Not for use with telephones that have a keypad in the handset.

Operation

Handset Type Switch

The three position switch on the back of Voice Path selects the type of microphone that is in the handset of your telephone. When you push in the **Record/Play** button, Voice Path replaces the handset microphone signal with a circuit that must match the characteristics of the handset microphone.

Note: Not all telephones are built alike so we cannot guarantee Voice Path will work with every handset design available. We designed the interface to work with most popular designs.

The Handset Type switch can cover the main three microphone types, but keep in mind that there is no industry standard for microphone types or characteristics and therefore we cannot guarantee a perfect match with every telephone. There is no way to tell which type of mic is in your telephone handset. Simply use the position that sounds best without clipping or signal break-up.

A	B	C
Electret	Dynamic	Carbon

Record/Playback Button

The **Record/Playback** button selects which signal will be sent down the phone line; the handset microphone, or the **<To Phone>** cable.

Recording (Position: Out)

1. Make certain the Record / Playback button is in the Out position.
2. Then start your recording from your software controls.
3. The level of the audio sent into your PC can be adjusted from the back of the unit. Place a small screwdriver into the hole marked **To PC ● Vol.** and turn...

Clockwise: Raise Level

Counter-clockwise: Lower Level

This is a passive unit so the signal can not be raised above mic level.

Play (Position: In)

1. Make certain the Record/Playback button is in the **In** position.
2. Start the audio playing on your computer.
3. Select the appropriate position on the **Handset Type** switch.
4. The audio playing on your computer will be sent down the telephone line to the other end of the call and to the handset earpiece. The handset microphone is disconnected while Voice Path is in the **Play** position.

FAQs

The headset I am currently using goes through an amplifier before it connects to my telephone. Will the Voice Path work with this headset?

If the amplifier was designed to connect to any telephone's handset jack then yes. The Voice Path goes between the amplifier and your telephone base. Simply connect the Voice Path modular jack marked **<Phone>** to the handset jack of your telephone base and the Voice Path modular jack marked **<Headset>** to the amplifier's modular jack (that usually connects to the telephone handset jack). Leave your headset connected to the amplifier as usual and it should work fine.

Can I still use my computer speakers when the Voice Path is connected?

Yes. You will need a Y-adapter for your sound card line output. This adapter should have 1 stereo mini plug (male) that splits into 2 stereo mini jacks (female). Plug the adapter into your sound card line output, plug your computer speakers into one of the adapter's mini jacks and the Voice Path "input from PC" cable into the other.

When playing back the recorded conversation, I can only hear the Caller's voice. Why can't I hear my voice?

Voice Path relies on the audio provided by your telephone's handset jack. Some telephones do not

provide audio from both sides of your conversation, only the far side. If your telephone is designed to only provide caller audio in the handset, you will have to try another telephone.

I have a Voice Path connected between my telephone and computer. I can record conversations to my sound card but cannot send audio (from the PC) down the phone line. What should I do?

1. Connect the cable marked **<To Phone>** on Voice Path to the line output or speaker output of your sound card. This is usually where you connect your PC speakers.
2. Make sure your computer volume (software) is at an acceptable level.
3. Complete a call to a friend who can listen and evaluate the signal. You will be able to hear their comments during the call.
4. Set the gray pushbutton on the Voice Path to the in position. This disables the handset microphone and enables the audio input.
5. Play an audio file on your computer. It should be long enough to complete this test (or select "loop playback" from your software).
6. Next, switch between the 3 handset type positions on the **Handset Type** switch on the back of the Voice Path. Select the position with the best audio quality (best does not necessarily mean loudest!). Then adjust the sound card output level using your software.

Block Diagram

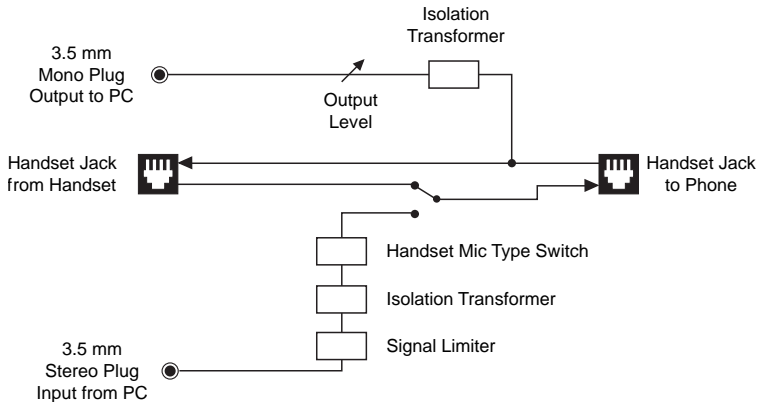

Specifications

Line Input

3.5 mm TRS (Left Channel Only) (48" cable)	10k ohms / 250 mV nominal
---	------------------------------

Output

3.5 mm TS (Mono) (48" cable)	2800 ohms 100 mV max
---------------------------------	-------------------------

Misc.

Isolation:	1500 VAC
Handset Jack:	RJ-22
Handset Type:	Electret, Dynamic, Carbon
Size:	3" x 1" x 2" (7.6 x 2.5 x 5.1 cm)
Weight:	9 oz

FCC Registration

Your new JK Audio product has been registered with the Federal Communications Commission (FCC). This product complies with the standards in Part 68 of the FCC rules.

1. Connection And Use With The Nationwide Telephone Network

The FCC requires that you connect this telephone equipment to the national telephone network through a USOC RJ-11C modular telephone jack. This equipment may not be used with Party Line Service or Coin Telephone Lines. This equipment is hearing aid compatible.

2. Information For The Telephone Company

Upon request from your local telephone company, you are required to provide the following information:

- a. The "line" to which you will connect the telephone equipment (that is, your telephone number), and
- b. The telephone equipment's FCC registration number. This can be found on the bottom of your telephone equipment.

FCC Registration

3. Repair Instructions

If it is determined that your telephone equipment is malfunctioning, the FCC requires that it not be used and that it be unplugged from the modular outlet until the problem has been corrected. Repairs to this telephone equipment can only be made by the manufacturer or its authorized agents or by others who may be authorized by the FCC. For repair procedures, follow the instructions outlined under the warranty section of the manual.

4. Rights Of The Telephone Company

If telephone equipment is causing harm to the network, the telephone company may temporarily discontinue your telephone service. If possible, they'll notify you before they interrupt service. If advanced notice isn't practical, you'll be notified as soon as possible. You'll be given the opportunity to correct the problem, and you'll be informed of your right to file a complaint with the FCC. Your telephone company may make changes in its facilities, equipment, operations or procedures that could affect the proper functioning of your JK Audio product. If such changes are planned, you'll be notified by your telephone company.

Voice Path™

Telephone Handset Audio Tap

User Guide Version 3/5/19

JK Audio, Inc.

1311 E 6th St.

Sandwich, IL 60548

United States

Telephone: 815.786.2929

Toll Free: 1.800.jkaudio

Fax: 815.786.8502

www.jkaudio.com

© 2019 JK Audio, Inc. All rights reserved.

JK Audio